

- Dimensions
- Specifications
- Lifting capacities main boom
- Working ranges main boom
- Working ranges main boom extension
- Lifting capacities main boom extension
- Technical description

Demag AC 80-1

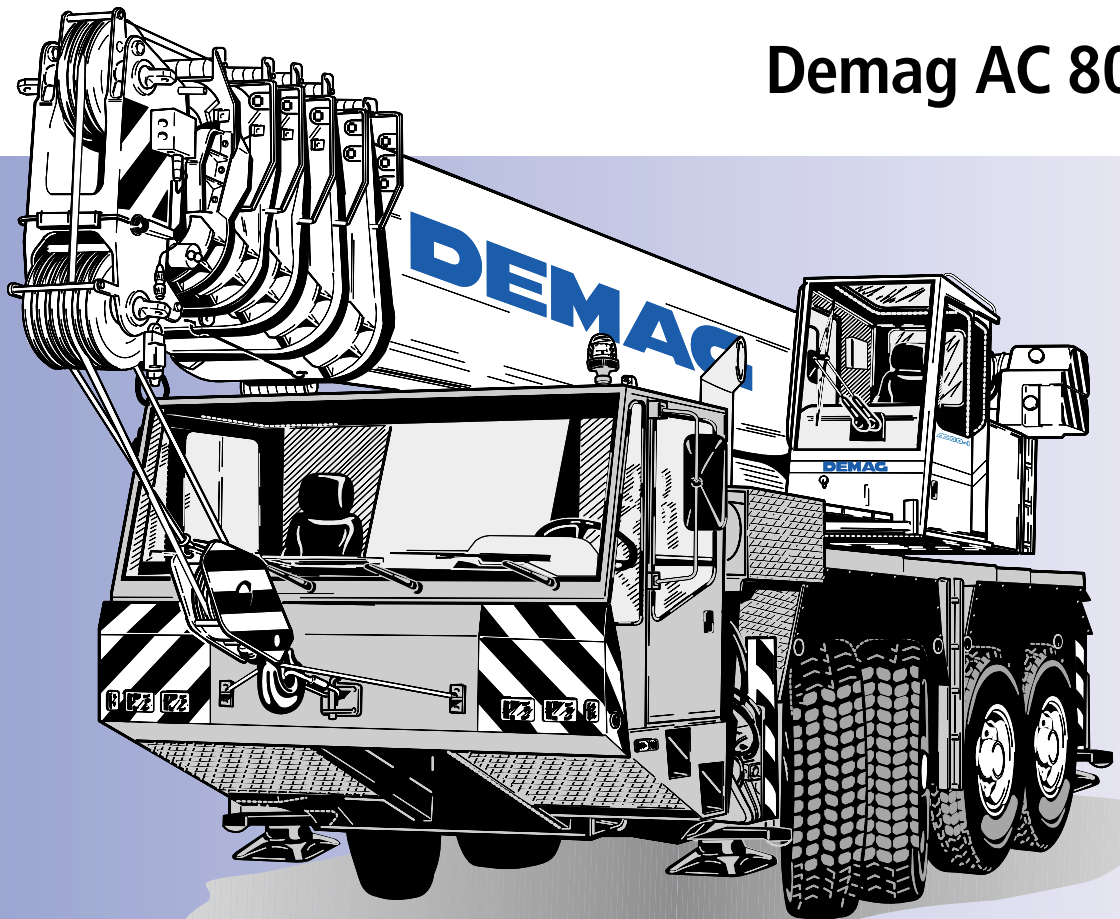

100t

MAXIM
CRANE WORKS
1-877-MAX-LIFT

MAIN MENU

Dimensions

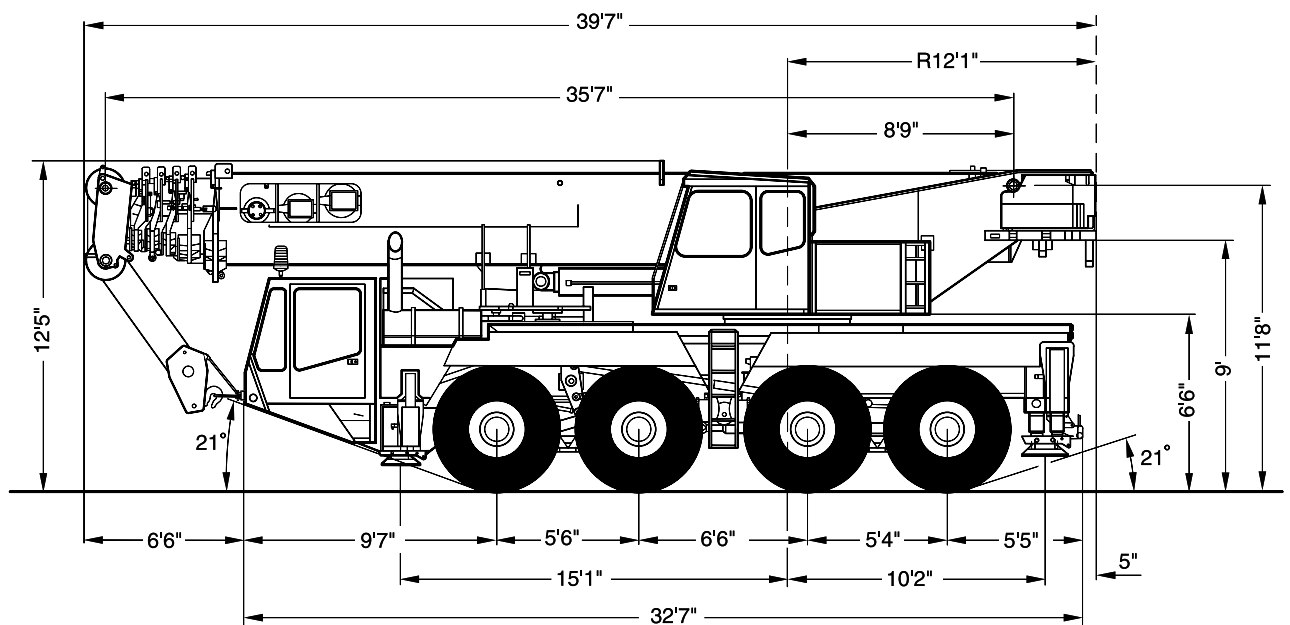

[MAIN MENU](#)

[CONTENTS](#)

Dimensions

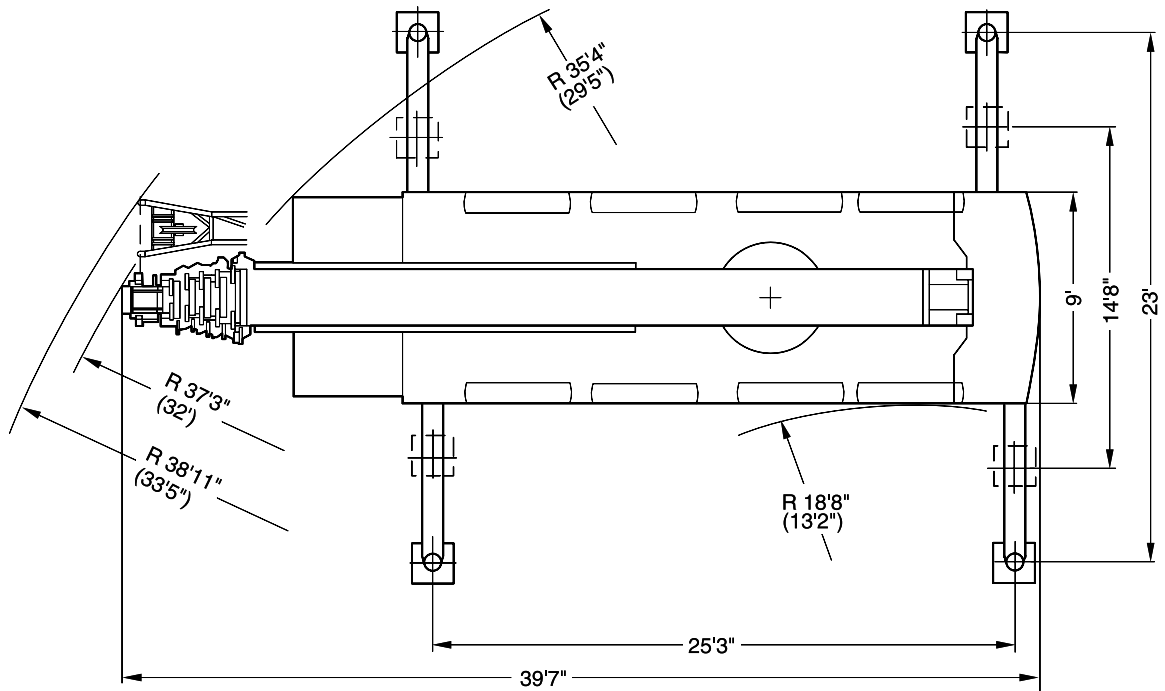
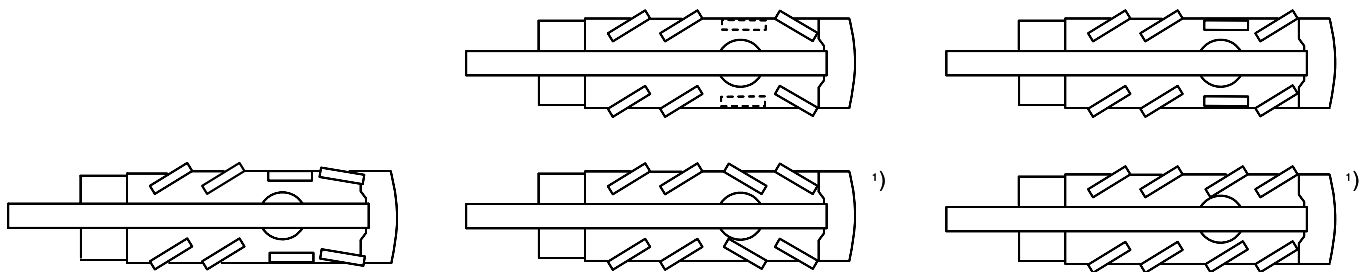

() with independent rear axle steering

¹⁾ optional

[MAIN MENU](#)

[CONTENTS](#)

Specifications

Axle loads

Basic machine, main boom, 30.2 ft main boom extension, single line hook, 17,600 lb counterweight, tires 14.00 R 25	
Axles	4 x 26,460 lb
Total	105,840 lb

Working speeds (infinitely variable)

Mechanisms	Normal speed	High speed	Max. permissible line pull ¹⁾	Length of hoist rope
Hoist I	174 ft/min	361 ft/min	13,200 lb	689 ft
Hoist II	174 ft/min	361 ft/min	13,200 lb	689 ft
Slewing				max. 2 rpm
Telescoping speed	35,8-164 ft: 110 s			
Boom elevation	-1.8° - +81.5°: 63 s			

Carrier performance

Travel speed	
Forward	0 to 46 mph
Reverse	0 to 7.5 mph
Gradeability in travel order	max. 50 %
Ground clearance	13 inches

Hook block/Single line hook

Type	Possible load	Number of sheaves	Number of lines	Weight	„D“
100*)	176,000 lb	7	14	1650 lb	6.6 ft
80*)	145,000 lb	5	11	1430 lb	6.6 ft
50	92,000 lb	3	7	1210 lb	5.9 ft
20	39,600 lb	1	3	770 lb	5.9 ft
6,3	13,200 lb	Single line hook	1	374 lb	5.6 ft

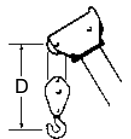

*) heavy-lift attachment is required, 2 add. sheaves

¹⁾ varies depending on national regulations

Notes to lifting capacity

Lifting capacities do not exceed 85% of tipping load.

Weight of hook blocks and slings are part of the load, and are to be deducted from the capacity ratings.

Crane operation is permissible up to a

wind speed of 32 ft/s

Consult operation manual for further details on wind speed.

Crane operation is subject to computer charts, only!

For crane operations consult operation manual first!

Lifting capacities main boom in 1,000 lb

39,700 lb																				85%	
		Length of main boom (ft)																		0° over rear	
Radius (ft)	35.8	52.8	70.2	70.6	82.0	82.0	102.4	102.8	103.2	121.9	121.9	122.1	138.5	138.9	138.9	151.3	151.3	164.0	35.8	52.8	
ft	1,000 lb																				
10	200.0*	-	-	-	-	-	-	-	-	-	-	-	-	-	-	-	-	-	-	-	
10	168.4	-	-	-	-	-	-	-	-	-	-	-	-	-	-	-	-	-	-	-	
11	160.1	133.3	-	-	-	-	-	-	-	-	-	-	-	-	-	-	-	-	-	-	
13	144.6	133.3	109.4	46.0	-	-	-	-	-	-	-	-	-	-	-	-	-	-	-	27.3	26.6
15	131.7	127.1	103.5	46.0	77.6	46.0	-	-	-	-	-	-	-	-	-	-	-	-	-	23.9	23.2
16	126.0	122.3	100.6	46.0	77.6	46.0	46.0	48.5	31.5	-	-	-	-	-	-	-	-	-	-	22.4	21.7
19	106.4	105.2	90.8	46.0	75.6	46.0	46.0	48.5	31.5	39.0	36.5	24.2	-	-	-	-	-	-	-	18.6	18.0
23	84.7	84.3	77.5	46.0	70.2	46.0	46.0	48.5	31.5	37.4	35.7	24.2	24.2	31.5	16.9	-	-	-	-	14.5	14.0
26	69.7	72.8	68.6	46.0	63.6	46.0	46.0	48.5	31.5	36.4	34.4	24.2	24.2	31.5	16.9	21.3	16.9	-	-	12.3	11.6
29	-	63.7	61.4	44.0	58.0	46.0	45.8	47.3	30.9	35.2	33.0	24.2	24.2	31.3	16.9	21.3	16.9	15.8	-	-	9.6
33	-	53.1	50.5	41.7	50.5	45.2	43.7	44.7	28.5	33.8	31.2	24.2	24.2	30.8	16.9	21.3	16.9	15.8	-	-	7.4
39	-	39.8	37.4	38.5	37.4	41.0	39.2	39.1	25.7	31.0	28.1	24.2	24.2	28.7	16.5	21.3	19.9	15.8	-	-	4.7
46	-	-	27.4	33.4	27.2	32.1	31.0	29.7	22.4	27.3	25.1	21.8	21.8	26.4	15.2	20.7	16.7	15.8	-	-	-
52	-	-	22.0	27.5	21.8	26.4	25.1	24.0	20.2	24.4	22.8	19.7	19.9	24.4	14.3	19.5	15.9	15.8	-	-	-
59	-	-	16.7	22.3	16.5	21.2	19.8	19.0	18.5	19.6	20.7	17.8	18.5	21.4	13.2	18.3	14.9	14.9	-	-	-
65	-	-	-	-	13.1	17.7	16.6	15.3	17.1	16.4	18.1	16.6	17.3	17.9	12.4	17.1	14.1	14.3	-	-	-
72	-	-	-	-	-	-	13.3	12.2	15.4	13.0	15.0	15.2	15.4	14.8	11.7	15.2	13.2	13.2	-	-	-
79	-	-	-	-	-	-	10.7	9.6	14.0	10.2	12.4	14.0	12.9	12.0	10.7	12.7	12.3	12.2	-	-	-
85	-	-	-	-	-	-	9.1	7.8	12.6	8.4	10.4	12.6	10.9	10.2	10.1	10.6	11.5	10.6	-	-	-
92	-	-	-	-	-	-	-	-	-	6.8	8.7	10.7	9.2	8.3	9.6	9.0	9.6	9.0	-	-	-
98	-	-	-	-	-	-	-	-	-	5.3	7.3	9.5	7.8	7.1	9.0	7.5	8.2	7.5	-	-	-
105	-	-	-	-	-	-	-	-	-	4.1	6.1	8.1	6.6	5.7	7.9	6.3	7.0	6.3	-	-	-
111	-	-	-	-	-	-	-	-	-	-	-	-	5.4	4.7	6.9	5.1	5.8	5.1	-	-	-
118	-	-	-	-	-	-	-	-	-	-	-	-	4.6	3.5	5.7	4.2	4.8	4.2	-	-	-
124	-	-	-	-	-	-	-	-	-	-	-	-	3.6	2.9	5.1	3.3	4.2	3.3	-	-	-
131	-	-	-	-	-	-	-	-	-	-	-	-	-	-	-	2.6	3.1	2.6	-	-	-
138	-	-	-	-	-	-	-	-	-	-	-	-	-	-	-	1.9	2.4	1.7	-	-	-

Boom extension sequence %



Tele 1	0	0	67	0	80	36	74	90	20	100	67	0	74	90	28	90	75	100	0	0
Tele 2	0	67	67	34	100	36	74	90	20	100	67	84	74	90	74	90	75	100	0	67
Tele 3	0	0	0	34	0	36	37	27	74	45	67	84	84	74	100	90	100	100	0	0
Tele 4	0	0	0	34	0	36	37	27	74	45	67	84	84	74	100	90	100	100	0	0
Tele 5	0	0	0	34	0	36	37	27	74	45	67	84	84	74	100	90	100	100	0	0

*) over rear

[MAIN MENU](#)

[CONTENTS](#)

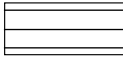
Lifting capacities main boom in 1,000 lb

17,600 lb						25'3" x 23'		360°				85%								
Radius (ft)	Length of main boom (ft)																0° over rear			
	35.8	52.8	70.2	70.6	82.0	82.0	102.4	102.8	103.2	121.9	121.9	122.1	138.5	138.9	138.9	151.3	151.3	164.0	35.8	52.8
ft	1,000 lb																1,000 lb			
10	200.0*	-	-	-	-	-	-	-	-	-	-	-	-	-	-	-	-	-	-	-
10	168.3	-	-	-	-	-	-	-	-	-	-	-	-	-	-	-	-	-	-	-
11	159.6	133.3	-	-	-	-	-	-	-	-	-	-	-	-	-	-	-	-	-	-
13	144.0	133.3	109.4	46.0	-	-	-	-	-	-	-	-	-	-	-	-	-	-	26.0	25.3
15	126.1	125.4	103.5	46.0	77.6	46.0	-	-	-	-	-	-	-	-	-	-	-	-	22.6	22.1
16	117.0	116.1	100.6	46.0	77.6	46.0	46.0	48.5	31.5	-	-	-	-	-	-	-	-	-	21.2	20.6
19	95.8	94.9	87.7	46.0	75.6	46.0	46.0	48.5	31.5	39.0	36.5	24.2	-	-	-	-	-	-	17.5	17.0
23	75.6	74.9	66.2	46.0	62.2	46.0	46.0	48.5	31.5	37.4	35.7	24.2	24.2	31.5	16.9	-	-	-	13.6	13.2
26	59.9	58.8	54.9	46.0	51.7	46.0	46.0	48.5	31.5	36.4	34.4	24.2	24.2	31.5	16.9	21.3	16.9	-	11.4	10.7
29	-	47.7	44.9	44.0	43.8	46.0	44.2	43.1	30.9	35.2	33.0	24.2	24.2	31.3	16.9	21.3	16.9	15.8	-	8.9
33	-	37.1	34.7	41.5	34.5	40.4	37.2	35.6	28.5	33.7	31.2	24.2	24.2	30.7	16.9	21.3	16.9	15.8	-	6.7
39	-	27.2	24.6	31.4	24.6	29.9	28.5	27.2	25.7	26.6	28.1	24.2	24.2	27.1	16.5	21.3	16.9	15.8	-	4.3
46	-	-	16.9	23.3	16.7	21.7	20.6	19.3	22.4	20.2	22.4	21.8	21.7	21.3	15.2	20.6	16.7	15.8	-	-
52	-	-	12.2	18.6	12.0	17.3	15.8	14.7	19.8	15.5	17.7	19.7	18.1	17.3	14.3	17.4	15.9	15.8	-	-
59	-	-	8.1	14.5	7.9	13.0	11.9	10.3	15.9	11.4	13.7	15.9	14.3	13.2	13.2	13.9	14.7	13.6	-	-
65	-	-	-	-	5.5	10.4	9.3	7.9	13.2	8.6	10.8	13.0	11.5	10.6	12.4	11.0	11.9	11.0	-	-
72	-	-	-	-	-	-	6.6	5.5	10.6	6.4	8.4	10.6	9.1	8.0	10.4	8.4	9.5	8.8	-	-
79	-	-	-	-	-	-	4.7	3.4	8.7	4.3	6.5	8.7	6.9	6.1	8.3	6.7	7.4	6.7	-	-
85	-	-	-	-	-	-	3.3	2.2	7.3	2.9	5.1	7.1	5.5	4.7	7.1	5.1	5.8	5.1	-	-
92	-	-	-	-	-	-	-	-	-	1.7	3.5	5.7	4.1	3.2	5.4	3.9	4.6	3.9	-	-
98	-	-	-	-	-	-	-	-	-	-	2.7	4.7	3.1	2.2	4.6	2.9	3.3	2.9	-	-
105	-	-	-	-	-	-	-	-	-	-	1.7	3.9	2.2	1.5	3.5	1.9	2.6	1.9	-	-
111	-	-	-	-	-	-	-	-	-	-	-	-	1.5	-	2.9	-	1.8	-	-	-
118	-	-	-	-	-	-	-	-	-	-	-	-	-	-	2.2	-	-	-	-	-
124	-	-	-	-	-	-	-	-	-	-	-	-	-	-	1.6	-	-	-	-	-

Boom extension sequence %

Tele 1	0	0	67	0	80	36	74	90	20	100	67	0	74	90	28	90	75	100	0	0
Tele 2	0	67	67	34	100	36	74	90	20	100	67	84	74	90	74	90	75	100	0	67
Tele 3	0	0	0	34	0	36	37	27	74	45	67	84	84	74	100	90	100	100	0	0
Tele 4	0	0	0	34	0	36	37	27	74	45	67	84	84	74	100	90	100	100	0	0
Tele 5	0	0	0	34	0	36	37	27	74	45	67	84	84	74	100	90	100	100	0	0

*) over rear

[MAIN MENU](#)

[CONTENTS](#)

Lifting capacities main boom in 1,000 lb

11,000 lb																				85%	
		Length of main boom (ft)																			
Radius (ft)	35.8	52.8	70.2	70.6	82.0	82.0	102.4	102.8	103.2	121.9	121.9	122.1	138.5	138.9	138.9	151.3	151.3	164.0	35.8	52.8	
ft	1,000 lb																		1,000 lb		
10	168.3	-	-	-	-	-	-	-	-	-	-	-	-	-	-	-	-	-	-	-	-
11	159.6	133.3	-	-	-	-	-	-	-	-	-	-	-	-	-	-	-	-	-	-	-
13	143.4	133.3	109.4	46.0	-	-	-	-	-	-	-	-	-	-	-	-	-	-	-	25.5	24.8
15	121.8	121.1	103.5	46.0	77.6	46.0	-	-	-	-	-	-	-	-	-	-	-	-	-	22.3	21.7
16	112.9	112.2	100.6	46.0	77.6	46.0	46.0	48.5	31.5	-	-	-	-	-	-	-	-	-	-	20.8	20.3
19	92.4	91.7	80.0	46.0	71.3	46.0	46.0	48.5	31.5	39.0	36.5	24.2	-	-	-	-	-	-	-	17.3	16.7
23	67.7	66.8	58.5	46.0	54.7	46.0	46.0	48.4	31.5	37.4	35.7	24.2	24.2	31.5	16.9	-	-	-	-	13.4	12.7
26	53.0	52.1	48.0	46.0	45.1	46.0	45.6	44.0	31.5	36.4	34.4	24.2	24.2	31.5	16.9	21.3	16.9	-	-	11.2	10.5
29	-	42.2	39.4	44.0	37.4	43.8	39.3	37.5	30.9	35.0	33.0	24.2	24.2	31.3	16.9	21.3	16.9	15.8	-	8.6	-
33	-	32.5	29.6	37.1	29.4	35.8	31.9	30.4	28.5	29.5	31.1	24.2	24.2	30.2	16.9	21.3	16.9	15.8	-	6.5	-
39	-	23.0	20.4	27.2	20.4	25.7	24.4	22.7	25.7	22.4	25.0	24.2	24.0	23.3	16.5	21.3	16.9	15.8	-	3.7	-
46	-	-	13.1	19.7	12.9	18.6	17.3	16.0	21.5	16.7	19.1	21.5	18.9	17.8	15.2	17.8	16.7	15.8	-	-	-
52	-	-	9.3	15.7	9.1	14.4	12.9	11.8	17.3	12.6	14.9	17.1	15.2	14.3	14.3	14.5	15.1	14.0	-	-	-
59	-	-	5.7	12.1	5.5	10.6	9.2	7.9	13.6	9.0	11.2	13.2	11.7	10.6	13.2	11.4	12.1	11.2	-	-	-
65	-	-	-	-	3.3	8.1	6.8	5.7	11.0	6.6	8.6	10.8	9.2	8.1	10.8	9.0	9.7	9.0	-	-	-
72	-	-	-	-	-	-	4.6	3.3	8.8	4.4	6.4	8.4	6.8	6.2	8.4	6.6	7.3	6.6	-	-	-
79	-	-	-	-	-	-	3.0	1.9	6.9	2.6	4.7	6.7	5.2	4.3	6.7	4.7	5.4	4.7	-	-	-
85	-	-	-	-	-	-	1.8	-	5.5	1.5	3.3	5.5	4.0	2.9	5.3	3.5	4.4	3.5	-	-	-
92	-	-	-	-	-	-	-	-	-	-	2.1	4.3	2.6	1.9	4.1	2.4	3.0	2.4	-	-	-
98	-	-	-	-	-	-	-	-	-	-	-	3.3	1.8	-	3.1	1.6	2.2	1.6	-	-	-
105	-	-	-	-	-	-	-	-	-	-	-	2.4	-	-	2.4	-	-	-	-	-	-
111	-	-	-	-	-	-	-	-	-	-	-	-	-	-	1.8	-	-	-	-	-	-

Boom extension sequence %

Tele 1	0	0	67	0	80	36	74	90	20	100	67	0	74	90	28	90	75	100	0	0
Tele 2	0	67	67	34	100	36	74	90	20	100	67	84	74	90	74	90	75	100	0	67
Tele 3	0	0	0	34	0	36	37	27	74	45	67	84	84	74	100	90	100	100	0	0
Tele 4	0	0	0	34	0	36	37	27	74	45	67	84	84	74	100	90	100	100	0	0
Tele 5	0	0	0	34	0	36	37	27	74	45	67	84	84	74	100	90	100	100	0	0

[MAIN MENU](#)

[CONTENTS](#)

Lifting capacities main boom in 1,000 lb

39,700 lb

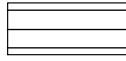

25'3" x 14'9" 360°

85%

Radius (ft)	Length of main boom (ft)																		
	35.8	52.8	70.2	70.6	82.0	82.0	102.4	102.8	103.2	121.9	121.9	122.1	138.5	138.9	138.9	151.3	151.3	164.0	
ft	1,000 lb																		
10	148.2	-	-	-	-	-	-	-	-	-	-	-	-	-	-	-	-	-	-
11	139.2	136.7	-	-	-	-	-	-	-	-	-	-	-	-	-	-	-	-	-
13	123.7	122.7	110.1	46.0	-	-	-	-	-	-	-	-	-	-	-	-	-	-	-
15	109.9	109.4	94.2	46.0	77.5	46.0	-	-	-	-	-	-	-	-	-	-	-	-	-
16	100.4	99.6	86.4	46.0	77.4	46.0	46.0	48.5	31.5	-	-	-	-	-	-	-	-	-	-
19	74.2	73.5	68.6	46.0	64.4	46.0	46.0	48.5	31.5	39.0	36.5	24.2	-	-	-	-	-	-	-
23	51.7	51.0	48.6	46.0	48.6	46.0	46.0	48.2	31.5	37.4	35.7	24.2	24.2	31.5	16.9	-	-	-	-
26	42.2	41.3	39.1	44.6	38.9	43.6	42.2	41.1	31.5	36.4	34.4	24.2	24.2	31.5	16.9	21.3	16.9	-	-
29	-	34.3	32.2	38.0	32.0	36.9	35.6	34.4	30.9	33.9	33.0	24.2	24.2	31.3	16.9	21.3	16.9	15.8	-
33	-	27.3	25.3	30.8	25.3	29.5	28.6	27.3	28.5	28.4	30.4	24.2	24.2	29.3	16.9	21.3	16.9	15.8	-
39	-	20.2	18.2	23.3	18.2	22.4	21.6	20.2	24.7	21.3	22.9	24.2	23.0	22.6	16.5	21.3	16.9	15.8	-
46	-	-	12.9	17.8	12.7	16.9	15.8	14.7	19.1	15.3	17.1	19.1	17.6	16.9	15.2	17.3	16.7	15.8	-
52	-	-	9.9	14.5	9.7	13.3	12.4	11.7	15.7	12.1	13.9	15.5	14.3	13.5	14.3	14.1	14.5	14.0	-
59	-	-	7.0	11.7	6.8	10.3	9.5	8.8	12.5	9.2	10.8	12.5	11.2	10.6	12.3	10.8	11.7	11.2	-
65	-	-	-	-	4.6	8.5	7.6	6.8	10.5	7.4	9.0	10.5	9.2	8.5	10.3	9.2	9.6	9.2	-
72	-	-	-	-	-	-	5.7	4.6	8.8	5.3	7.1	8.4	7.3	6.8	8.4	7.1	7.7	7.3	-
79	-	-	-	-	-	-	4.1	3.0	7.2	3.9	5.4	7.2	6.1	5.2	7.0	5.6	6.3	5.6	-
85	-	-	-	-	-	-	2.9	1.8	6.2	2.4	4.4	6.2	4.9	4.2	5.7	4.6	5.1	4.6	-
92	-	-	-	-	-	-	-	-	-	1.5	3.0	5.0	3.5	2.6	4.8	3.2	4.1	3.2	-
98	-	-	-	-	-	-	-	-	-	-	2.2	4.2	2.7	1.8	4.2	2.4	3.1	2.4	-
105	-	-	-	-	-	-	-	-	-	-	1.5	3.3	1.7	-	3.0	1.5	2.2	1.5	-
111	-	-	-	-	-	-	-	-	-	-	-	-	-	-	2.4	-	1.5	-	-
118	-	-	-	-	-	-	-	-	-	-	-	-	-	-	1.7	-	-	-	-

Boom extension sequence %

Tele 1	0	0	67	0	80	36	74	90	20	100	67	0	74	90	28	90	75	100
Tele 2	0	67	67	34	100	36	74	90	20	100	67	84	74	90	74	90	75	100
Tele 3	0	0	0	34	0	36	37	27	74	45	67	84	84	74	100	90	100	100
Tele 4	0	0	0	34	0	36	37	27	74	45	67	84	84	74	100	90	100	100
Tele 5	0	0	0	34	0	36	37	27	74	45	67	84	84	74	100	90	100	100

MAIN MENU

CONTENTS

Lifting capacities main boom in 1,000 lb

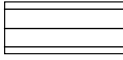
17,600 lb   **25'3" x 14'9"** **360°** **85%**

Radius (ft)	Length of main boom (ft)																		
	35.8	52.8	70.2	70.6	82.0	82.0	102.4	102.8	103.2	121.9	121.9	122.1	138.5	138.9	138.9	151.3	151.3	164.0	
ft	1,000 lb																		
10	144.1	-	-	-	-	-	-	-	-	-	-	-	-	-	-	-	-	-	-
11	135.3	119.9	-	-	-	-	-	-	-	-	-	-	-	-	-	-	-	-	-
13	111.2	94.3	77.6	46.0	-	-	-	-	-	-	-	-	-	-	-	-	-	-	-
15	80.6	76.0	63.5	46.0	58.1	46.0	-	-	-	-	-	-	-	-	-	-	-	-	-
16	70.3	68.5	58.0	46.0	53.3	46.0	46.7	49.7	31.5	-	-	-	-	-	-	-	-	-	-
19	50.2	49.6	45.3	46.0	41.9	46.0	41.5	40.6	31.5	37.7	37.2	24.2	-	-	-	-	-	-	-
23	34.3	33.6	31.2	38.0	31.0	36.5	32.7	31.0	31.5	29.7	32.3	24.2	24.2	29.7	16.9	-	-	-	-
26	27.4	26.5	24.3	30.5	24.3	29.4	27.5	25.9	31.5	25.0	27.7	24.2	24.2	25.4	16.9	21.3	16.9	-	-
29	-	21.5	19.5	25.3	19.3	24.2	22.8	21.6	27.0	21.3	24.0	24.2	22.7	21.9	16.9	21.3	16.9	15.8	-
33	-	16.6	14.6	20.1	14.3	19.0	17.6	16.8	21.6	17.2	19.4	21.6	19.2	18.3	16.9	18.1	16.9	15.7	-
39	-	11.7	9.7	14.8	9.5	13.9	12.6	11.7	16.4	12.4	14.4	16.4	14.8	13.9	15.9	14.1	14.6	13.3	-
46	-	-	5.7	10.7	5.4	9.6	8.7	7.6	12.0	8.3	10.1	12.0	10.5	9.8	11.8	10.3	11.2	9.8	-
52	-	-	3.0	8.3	2.8	7.2	6.3	5.2	9.4	5.9	7.6	9.4	8.1	7.4	9.4	7.9	8.3	7.6	-
59	-	-	-	6.4	-	5.0	3.9	2.6	7.2	3.5	5.5	7.2	5.7	5.3	7.0	5.7	6.4	5.5	-
65	-	-	-	-	-	3.4	2.3	-	5.8	1.9	4.1	5.6	4.5	3.4	5.6	4.3	4.7	4.1	-
72	-	-	-	-	-	-	-	-	4.4	-	2.4	4.4	2.9	2.0	4.4	2.4	3.1	2.4	-
79	-	-	-	-	-	-	-	-	3.2	-	-	3.0	1.7	-	3.0	-	1.9	-	-
85	-	-	-	-	-	-	-	-	2.4	-	-	2.2	-	-	2.0	-	-	-	-

Boom extension sequence %

Tele 1	0	0	67	0	80	36	74	90	20	100	67	0	74	90	28	90	75	100
Tele 2	0	67	67	34	100	36	74	90	20	100	67	84	74	90	74	90	75	100
Tele 3	0	0	0	34	0	36	37	27	74	45	67	84	84	74	100	90	100	100
Tele 4	0	0	0	34	0	36	37	27	74	45	67	84	84	74	100	90	100	100
Tele 5	0	0	0	34	0	36	37	27	74	45	67	84	84	74	100	90	100	100

[MAIN MENU](#)

[CONTENTS](#)

Lifting capacities main boom in 1,000 lb

11,000 lb  **25'3" x 14'9"** **360°** **85%**

Radius (ft)	Length of main boom (ft)																		
	35.8	52.8	70.2	70.6	82.0	82.0	102.4	102.8	103.2	121.9	121.9	122.1	138.5	138.9	138.9	151.3	151.3	164.0	
ft	1,000 lb																		
10	142.2	-	-	-	-	-	-	-	-	-	-	-	-	-	-	-	-	-	-
11	128.5	104.4	-	-	-	-	-	-	-	-	-	-	-	-	-	-	-	-	-
13	97.4	81.8	66.4	46.0	-	-	-	-	-	-	-	-	-	-	-	-	-	-	-
15	70.1	65.6	54.1	46.0	49.4	46.0	-	-	-	-	-	-	-	-	-	-	-	-	-
16	61.0	59.1	49.1	46.0	45.1	46.0	44.5	42.5	31.5	-	-	-	-	-	-	-	-	-	-
19	43.1	42.4	38.1	44.3	35.2	41.1	36.1	34.2	31.5	32.1	35.0	24.2	-	-	-	-	-	-	-
23	29.0	28.3	25.9	32.9	25.5	31.4	27.5	25.9	31.4	24.8	27.5	24.2	24.2	25.0	16.9	-	-	-	-
26	22.9	22.3	19.9	26.5	19.8	25.0	22.8	21.3	27.8	20.6	23.2	24.2	22.2	21.4	16.9	21.1	16.9	-	-
29	-	17.7	15.7	21.7	15.5	20.4	19.1	17.6	23.3	17.3	19.9	22.4	19.2	18.2	16.9	18.1	16.9	16.1	-
33	-	13.5	11.5	17.0	11.3	15.9	14.6	13.7	18.5	13.7	16.3	18.5	15.9	14.8	16.8	14.8	15.7	14.2	-
39	-	9.0	7.3	12.4	7.0	11.1	10.1	9.3	13.5	9.7	11.7	13.5	11.9	10.8	13.4	11.0	12.1	10.5	-
46	-	-	3.2	8.7	3.0	7.6	6.5	5.4	9.8	6.3	7.9	9.8	8.3	7.6	9.8	7.9	8.7	7.4	-
52	-	-	-	6.5	-	5.4	4.3	3.0	7.6	4.1	5.8	7.6	6.3	5.4	7.6	5.6	6.7	5.4	-
59	-	-	-	4.6	-	3.3	2.0	-	5.7	1.7	3.9	5.5	4.4	3.3	5.5	3.9	4.6	3.5	-
65	-	-	-	-	-	1.9	-	-	4.5	-	2.3	4.5	2.8	1.9	4.3	2.3	3.2	2.1	-
72	-	-	-	-	-	-	-	-	2.9	-	-	2.9	-	-	2.9	-	1.8	-	-
79	-	-	-	-	-	-	-	-	1.9	-	-	1.9	-	-	1.7	-	-	-	-

Boom extension sequence %

Tele 1	0	0	67	0	80	36	74	90	20	100	67	0	74	90	28	90	75	100
Tele 2	0	67	67	34	100	36	74	90	20	100	67	84	74	90	74	90	75	100
Tele 3	0	0	0	34	0	36	37	27	74	45	67	84	84	74	100	90	100	100
Tele 4	0	0	0	34	0	36	37	27	74	45	67	84	84	74	100	90	100	100
Tele 5	0	0	0	34	0	36	37	27	74	45	67	84	84	74	100	90	100	100

[MAIN MENU](#)

[CONTENTS](#)

Working range main boom

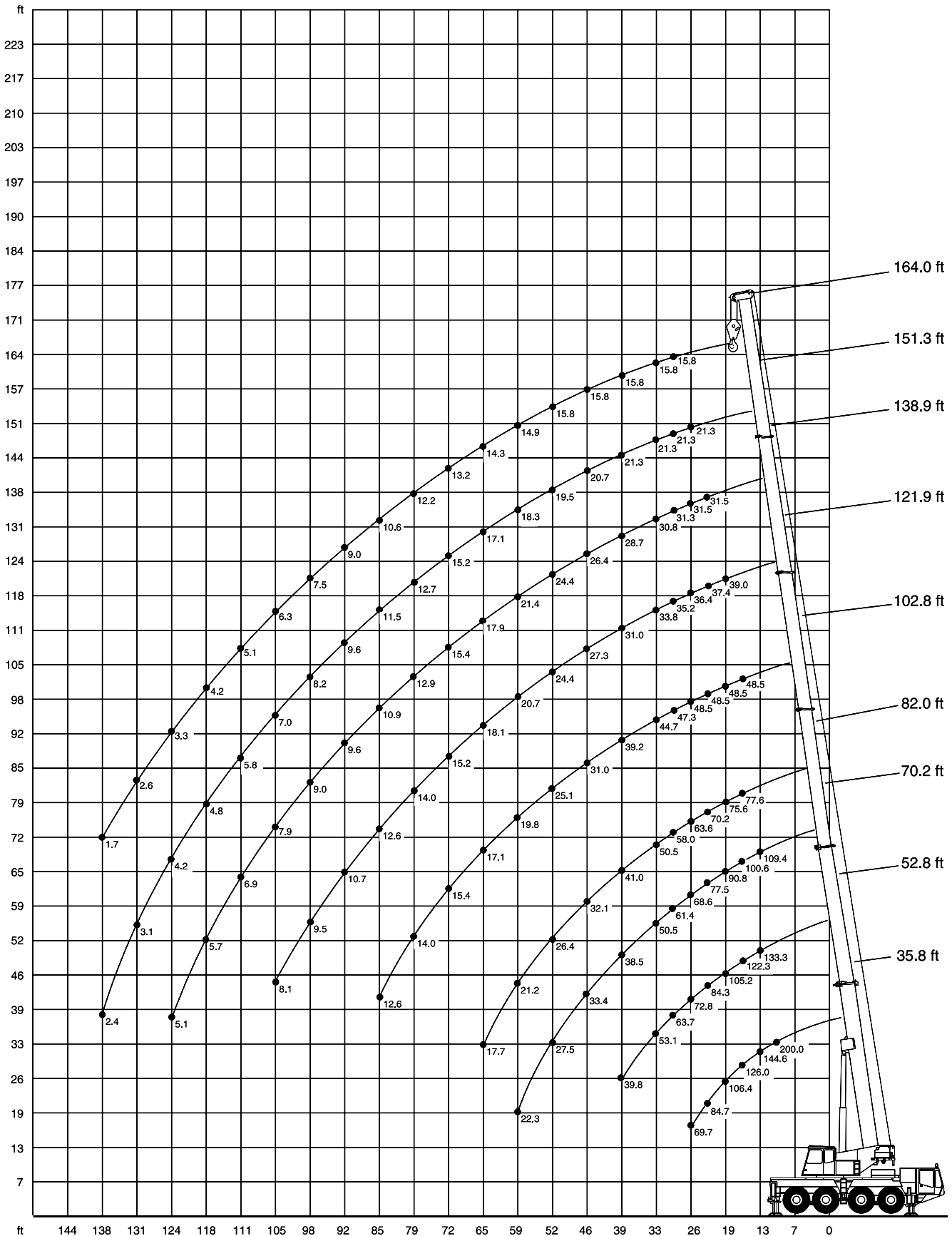

[MAIN MENU](#)

[CONTENTS](#)

Working range main boom extension

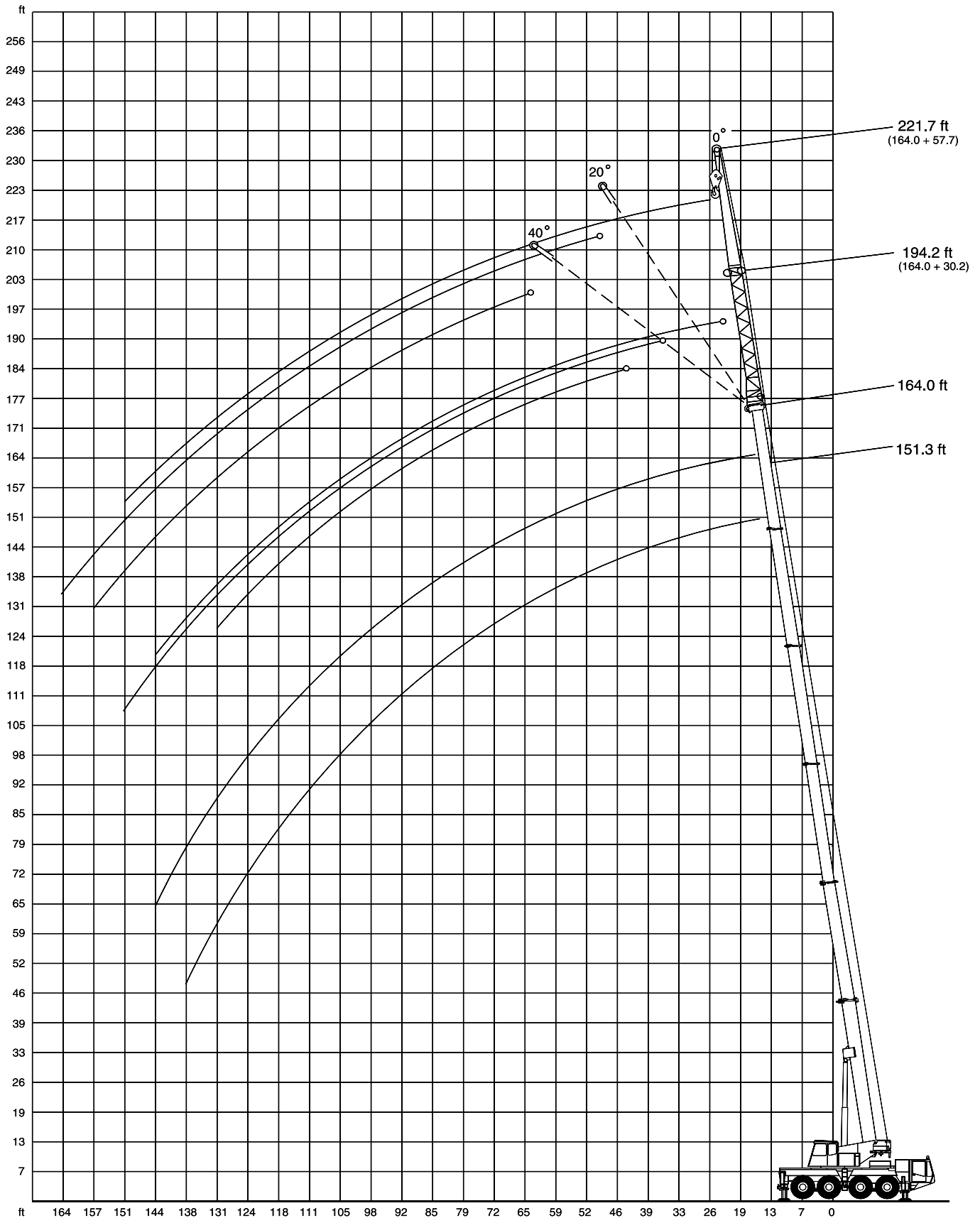

[MAIN MENU](#)

[CONTENTS](#)

Lifting capacities main boom extension in 1,000 lb

Main boom: 151.3 ft

39,700 lb 25'3" x 23' 360° 85%

Radius ft	Extension					
	30.2 ft			57.7 ft		
	0°	20°	40°	0°	20°	40°
ft	1,000 lb					
33	9.4	-	-	-	-	-
39	9.4	-	-	4.1	-	-
46	9.4	8.1	-	4.1	-	-
52	9.4	8.1	7.2	4.1	-	-
59	9.4	7.9	7.2	4.1	3.3	-
65	9.0	7.7	7.0	3.9	3.3	-
72	8.3	7.5	6.8	3.5	3.3	-
79	7.9	7.0	6.6	3.5	3.3	2.8
85	7.5	6.8	6.4	3.3	3.3	2.6
92	7.2	6.3	6.1	3.3	3.3	2.6
98	6.8	6.1	5.7	3.1	3.1	2.6
105	6.6	5.7	5.5	3.0	2.8	2.6
111	5.8	5.5	5.3	2.8	2.6	2.6
118	4.8	5.2	5.0	2.8	2.6	2.6
124	4.0	4.5	4.6	2.6	2.6	2.4
131	3.1	3.5	3.9	2.6	2.6	2.4
138	2.4	2.8	-	2.6	2.6	2.4
144	2.0	2.2	-	2.4	2.6	2.4
151	-	1.5	-	1.9	2.6	2.4
157	-	-	-	1.5	2.0	2.4
164	-	-	-	-	1.5	-

17,600 lb 25'3" x 23' 360° 85%

Radius ft	Extension					
	30.2 ft			57.7 ft		
	0°	20°	40°	0°	20°	40°
ft	1,000 lb					
33	9.4	-	-	-	-	-
39	9.4	-	-	4.1	-	-
46	9.4	8.1	-	4.1	-	-
52	9.4	8.1	7.2	4.1	-	-
59	9.4	7.9	7.2	4.1	3.3	-
65	9.0	7.7	7.0	3.9	3.3	-
72	8.3	7.5	6.8	3.5	3.3	-
79	7.4	7.0	6.6	3.5	3.3	2.8
85	5.8	6.8	6.4	3.3	3.3	2.6
92	4.6	5.4	6.1	3.3	3.3	2.6
98	3.3	4.4	4.9	3.1	3.1	2.6
105	2.4	3.0	3.5	3.0	2.8	2.6
111	1.8	2.4	2.7	2.4	2.6	2.6
118	-	1.5	1.9	1.7	2.6	2.6
124	-	-	-	-	2.0	2.4
131	-	-	-	-	1.5	2.2
138	-	-	-	-	-	1.5
144	-	-	-	-	-	-
151	-	-	-	-	-	-
157	-	-	-	-	-	-
164	-	-	-	-	-	-

11,000 lb 25'3" x 23' 360° 85%

Radius ft	Extension					
	30.2 ft			57.7 ft		
	0°	20°	40°	0°	20°	40°
ft	1,000 lb					
33	9.4	-	-	-	-	-
39	9.4	-	-	4.1	-	-
46	9.4	8.1	-	4.1	-	-
52	9.4	8.1	7.2	4.1	-	-
59	9.4	7.9	7.2	4.1	3.3	-
65	9.0	7.7	7.0	3.9	3.3	-
72	7.5	7.5	6.8	3.5	3.3	-
79	5.4	6.7	6.5	3.5	3.3	2.8
85	4.4	5.3	6.1	3.3	3.3	2.6
92	3.0	4.1	4.6	3.2	3.3	2.6
98	2.0	2.9	3.3	2.6	3.1	2.6
105	-	1.9	2.4	1.9	2.8	2.6
111	-	-	1.6	-	2.4	2.6
118	-	-	-	-	1.7	2.6
124	-	-	-	-	-	2.0

Lifting capacities main boom extension in 1,000 lb

Main boom: 164.0 ft

39,700 lb  **25'3" x 23'** **360° 85%**

Radius ft	Extension					
	30.2 ft			57.7 ft		
	0°	20°	40°	0°	20°	40°
ft	1,000 lb					
39	7.2	-	-	-	-	-
46	7.2	7.2	-	2.8	-	-
52	7.2	7.2	6.6	2.8	-	-
59	7.2	7.0	6.6	2.8	-	-
65	7.0	6.8	6.4	2.8	2.6	-
72	6.8	6.6	6.1	2.6	2.6	-
79	6.3	6.1	5.5	2.6	2.6	2.4
85	6.1	5.7	5.3	2.4	2.6	2.4
92	5.5	5.2	5.0	2.4	2.4	2.4
98	5.3	5.0	4.8	2.4	2.4	2.4
105	5.0	4.8	4.6	2.4	2.4	2.4
111	4.8	4.6	4.6	2.2	2.4	2.4
118	4.6	4.4	4.4	2.2	2.2	2.2
124	3.6	4.4	4.4	2.2	2.2	2.2
131	2.8	3.3	3.9	1.9	2.2	2.2
138	2.1	2.6	-	1.9	2.1	2.2
144	1.7	2.2	-	1.7	1.9	2.2
151	-	1.5	-	1.7	1.9	1.9
157	-	-	-	-	1.9	1.9
164	-	-	-	-	1.5	-

17,600 lb  **25'3" x 23'** **360° 85%**



Radius ft	Extension					
	30.2 ft			57.7 ft		
	0°	20°	40°	0°	20°	40°
ft	1,000 lb					
39	7.2	-	-	-	-	-
46	7.2	7.2	-	2.8	-	-
52	7.2	7.2	6.6	2.8	-	-
59	7.2	7.0	6.6	2.8	-	-
65	7.0	6.8	6.4	2.8	2.6	-
72	6.8	6.6	6.1	2.6	2.6	-
79	6.3	6.1	5.5	2.6	2.6	2.4
85	5.7	5.7	5.3	2.4	2.6	2.4
92	4.3	5.2	5.0	2.4	2.4	2.4
98	3.3	4.2	4.8	2.4	2.4	2.4
105	2.4	3.0	3.5	2.4	2.4	2.4
111	1.6	2.2	2.7	2.2	2.4	2.4
118	-	1.5	1.9	1.5	2.2	2.2
124	-	-	-	-	2.0	2.2
131	-	-	-	-	-	1.9
138	-	-	-	-	-	-
144	-	-	-	-	-	-
151	-	-	-	-	-	-
157	-	-	-	-	-	-
164	-	-	-	-	-	-

11,000 lb  **25'3" x 23'** **360° 85%**



Radius ft	Extension					
	30.2 ft			57.7 ft		
	0°	20°	40°	0°	20°	40°
ft	1,000 lb					
39	7.2	-	-	-	-	-
46	7.2	7.2	-	2.8	-	-
52	7.2	7.2	6.6	2.8	-	-
59	7.2	7.0	6.6	2.8	-	-
65	7.0	6.8	6.4	2.8	2.6	-
72	6.8	6.6	6.1	2.6	2.6	-
79	5.2	6.1	5.5	2.6	2.6	2.4
85	4.2	5.1	5.3	2.4	2.6	2.4
92	2.8	3.9	4.6	2.4	2.4	2.4
98	2.0	2.9	3.3	2.4	2.4	2.4
105	-	1.9	2.4	1.5	2.4	2.4
111	-	-	1.6	-	2.2	2.4
118	-	-	-	-	1.5	2.2
124	-	-	-	-	-	1.8

Lifting capacities main boom extension in 1,000 lb

Main boom: 151.3 ft

39,700 lb   25'3" x 14'9" 360° 85%

Radius ft	Extension					
	30.2 ft			57.7 ft		
	0°	20°	40°	0°	20°	40°
ft	1,000 lb					
33	9.4	-	-	-	-	-
39	9.4	-	-	4.1	-	-
46	9.4	8.1	-	4.1	-	-
52	9.4	8.1	7.2	4.1	-	-
59	9.4	7.9	7.2	4.1	3.3	-
65	9.0	7.7	7.0	3.9	3.3	-
72	7.7	7.5	6.8	3.5	3.3	-
79	6.3	7.0	6.6	3.5	3.3	2.8
85	5.1	5.7	6.4	3.3	3.3	2.6
92	3.9	4.6	5.2	3.3	3.3	2.6
98	2.9	3.5	4.2	3.1	3.1	2.6
105	1.9	2.6	3.0	2.6	2.8	2.6
111	-	2.0	2.2	2.0	2.6	2.6
118	-	-	1.5	-	2.4	2.6
124	-	-	-	-	1.8	2.4
131	-	-	-	-	-	1.7

17,600 lb   25'3" x 14'9" 360° 85%

Radius ft	Extension					
	30.2 ft			57.7 ft		
	0°	20°	40°	0°	20°	40°
ft	1,000 lb					
33	9.4	-	-	-	-	-
39	9.4	-	-	4.1	-	-
46	9.4	8.1	-	4.1	-	-
52	8.0	8.1	7.2	4.1	-	-
59	6.1	7.5	7.2	4.1	3.3	-
65	4.5	5.8	6.8	3.9	3.3	-
72	2.9	4.2	5.1	3.3	3.3	-
79	1.7	2.8	3.9	2.1	3.2	2.8
85	-	1.8	2.7	-	3.0	2.6
92	-	-	1.7	-	2.1	2.6
98	-	-	-	-	-	2.6
105	-	-	-	-	-	1.7
111	-	-	-	-	-	-
118	-	-	-	-	-	-
124	-	-	-	-	-	-
131	-	-	-	-	-	-

Main boom: 164.0 ft

39,700 lb   25'3" x 14'9" 360° 85%

Radius ft	Extension					
	30.2 ft			57.7 ft		
	0°	20°	40°	0°	20°	40°
ft	1,000 lb					
39	7.2	-	-	-	-	-
46	7.2	7.2	-	2.8	-	-
52	7.2	7.2	6.6	2.8	-	-
59	7.2	7.0	6.6	2.8	-	-
65	7.0	6.8	6.4	2.8	2.6	-
72	6.8	6.6	6.1	2.6	2.6	-
79	6.1	6.1	5.5	2.6	2.6	2.4
85	4.9	5.7	5.3	2.4	2.6	2.4
92	3.9	4.6	5.0	2.4	2.4	2.4
98	2.7	3.5	4.2	2.4	2.4	2.4
105	1.9	2.6	3.0	2.4	2.4	2.4
111	-	1.8	2.2	1.8	2.4	2.4
118	-	-	1.5	-	2.2	2.2
124	-	-	-	-	1.6	2.2
131	-	-	-	-	-	1.7

17,600 lb   25'3" x 14'9" 360° 85%

Radius ft	Extension					
	30.2 ft			57.7 ft		
	0°	20°	40°	0°	20°	40°
ft	1,000 lb					
39	7.2	-	-	-	-	-
46	7.2	7.2	-	2.8	-	-
52	7.2	7.2	6.6	2.8	-	-
59	5.5	7.0	6.6	2.8	-	-
65	4.1	5.4	6.4	2.8	2.6	-
72	2.4	4.0	4.8	2.6	2.6	-
79	1.5	2.6	3.2	1.7	2.6	2.4
85	-	1.5	2.4	-	2.6	2.4
92	-	-	-	-	1.7	2.4
98	-	-	-	-	-	2.2
105	-	-	-	-	-	1.5
111	-	-	-	-	-	-
118	-	-	-	-	-	-
124	-	-	-	-	-	-
131	-	-	-	-	-	-

Technical description

Carrier

Drive/steering	8 x 6 x 6
Frame	Monobox main frame with outrigger boxes integral, of high-strength fine-grain structural steel.
Outriggers	Four hydraulically telescoping outrigger beams with hydraulic jack legs.
Engine	Daimler-Benz OM 402 LA water-cooled 8-cylinder engine. Output to DIN: 280 kW (380 hp) at 2100 rpm. Max. torque: 1775 Nm at 1200 rpm. Fuel tank capacity: 400 l.
Transmission	Allison automatic transmission, transfer case with off-road range.
Axles	1st: steering. 2nd: steering. 3rd: rigid, non-steering. 4th: steering. Axles 1, 2 and 4 with planetary hubs. Differential lock-out control on 2nd axle: longitudinal and transverse. 1st and 4th axle: transverse.
Suspension	Hydropneumatic suspension, all axles hydraulically blockable.
Wheels and tyres	8 x 14.00 R 25 on 11.25-25 rims; tubeless road-tread tyres. All axles single-wheeled.
Steering	Dual-circuit semiblock mechanical steering with hydraulic booster.
Brakes	Service brake: dual-line air system, acting on all wheels. Parking brake: spring-loaded type. Sustained action brake: engine exhaust brake and constant decompression valve.
Electrical equipment	24 V.
Driver's cab	Rubber-mounted steel cab with safety glass, slide-by side windows, carrier controls, driver's and passenger's seat, vertically adjustable steering wheel, heated outside mirrors, rotary beacon.

Superstructure

Hydraulic system	Driven off carrier engine at low revs, 1 variable-displacement axial piston pump and separate fixed-displacement pump for 4 simultaneous, independent working movements.
Hoist	Fixed displacement axial-piston motor, hoist drum with planetary reduction integral and spring-applied holding brake.
Slew unit	Hydraulic motor with planetary reduction, foot-pedal brake and spring-applied holding brake.
Derricking unit	1 differential cylinder with pilot-controlled lowering brake valve.
Crane cab	Spacious all-steel comfortable cab with sliding door, large folding-out windscreen, roof window with armoured glass, controls and instrumentation for all crane movements, working light. Self-contained air heater and 7-day programmable timer, thermostat controlled. Windscreen washer and intermittent-control wiper.
Main boom	Boom base and 5 telescopic sections of fine-grain structural steel, telescoping with partial load, buckling-resistant Demag ovaloid design.
Counterweight	17,600 lb in sections of 11,250 lb, 3,750 lb and 2,650 lb (15,000 lb fitted on superstructure, 2,650 lb hydraulically stowed on carrier deck).
Safety devices	Electronic safe load indicator with digital read-out for hook load, rated load, boom length, boom angle, load radius, analog display to indicate the capacity utilization. Limit switches on hoist and lowering motions, pressure-relief and safety holding valves.
Hydraulic servo control	Hydraulic pilot control through self-centering control levers.

Optional equipment

Drive/steering	8 x 8 x 8
Tyres	Optional 16.00 R 25 on 11.25-25 rims; 20.5 R 25 on 17.00-25 rims.
Tow coupling	D-value 12 t or 19 t, air-brake connection.
Hoist II	Fixed displacement axial piston motor, hoist drum with integral planetary reduction integral and spring-applied holding brake. Hoist II avoids re-reeving of hoist line when using the optional jib.
Main boom extension	1 or 2-part folding jib, 30.2 ft or 57.7 ft. 0°, 20° and 40° offset.
Additional counterweight	22,050 lb, integrated into standard counterweight, installed hydraulically by the crane itself.
Heavy-lift attachment	Additional sheaves on boom head for duties over 132,000 lb.
Heavy-lift runner	3.3 ft long, 3-sheave, for workshop applications. Stowed on carrier during transit.