

MAXIM
1-877-MAX-LIFT

GROVE[®]
by **Manitowoc**

RT540E

Product Guide

Ansi B30.5
Imperial 85%



Features

- 35 t (40 USt) capacity
- 9,8 m – 31 m (32 ft – 102 ft) four-section full-power boom
- 7,9 m – 13,7 m (26 ft – 45 ft) offsettable telescopic swingaway extension
- Full vision cab design
- Intuitive, user friendly controls with electronic joysticks and operator customizable function speeds
- Full frame decking
- 122 kW (164 hp) Cummins diesel engine (Tier 4F)

GROVE RT540E

Grove design and engineering expertise have been developed through years of manufacturing an outstanding line of performance-proven, rough-terrain cranes. The RT540E builds upon this tradition with exceptional mobility and fast set-up on any job-site.

Features

> Boom

The RT540E is equipped with a 9,8 m – 31 m (32 ft – 102 ft) four-section full power boom. The boom incorporates a rectangular boom shape made from 100 ksi steel, which eliminates weight and maximizes structural capacities.



> Crane Control System (CCS)

The Crane Control System (CCS) offers a user friendly interface, two full graphic displays mounted vertically for easier viewing and a jog dial for easier navigation and data input. The system allows the electronic controllers to be reprogrammed by the operator for specific speed and reaction.



> Cab

The Full Vision cab with tilt-telescoping steering wheel, electronic single or dual-axis controllers, hot water heat and air conditioning provides all day comfort for the operator.



> Tip height

The RT540E offers a 7,9 m – 13,7 m (26 ft – 45 ft) offsettable telescopic swingaway providing a maximum tip height of 47 m (154 ft).



> CraneSTAR is an exclusive and innovative crane asset management system

that helps improve your profitability and reduce costs by remotely monitoring critical crane data. Visit www.cranestar.com for more information.

Job site benefits

> **Exceptional maneuverability**

Maneuvering around the job site is easier with Grove rough-terrain cranes. Four-wheel drive combined with four modes of steering (front only, rear only, crab and coordinated) allows operators to get closer to the lift regardless of congested areas or adverse ground conditions. All modes are controlled through steering wheel and rocker switches, so there's no need for operators to stop and align the wheels.

> **Job site flexibility means more lifts for greater profitability**

Grove rough-terrain cranes can be reconfigured to fit numerous lifting applications, giving you more lifting versatility. That provides you with the potential to win more jobs for greater profitability and return on investment.

> **Innovation drives enhanced operation and efficiency**

Grove utilizes the latest technology to provide the highest work efficiency and safety — all while meeting today's strict environmental standards. Our innovations ensure reliable crane performance along with operator productivity and comfort.



Manitowoc Crane Care when you need it.
The assurance of the world's most advanced crane service and support to get you back to work fast.



Manitowoc Finance helps you get right to work generating profits for your business.
Financial tools that help you capitalize on opportunity with solutions that fit your needs.

Contents

Dimensions and weights	5
Working range	6
Load charts	7
Load handling	12
Specifications	13
Symbols glossary	15

Dimensions and weights

Dimensions

	Tire size	A	B	C	D	E	F	G	H	J	K	L
2-wheel steer	20.5 x 25	13 563 mm (534 in)	13 328 mm (525 in)	10 899 mm (429 in)	10 236 mm (403 in)	10 007 mm (394 in)	8138 mm (320 in)	7021 mm (276 in)	2055 mm (81 in)	25.0°	23.0°	2606 mm (103 in)
	16.0 x 25	13 563 mm (534 in)	13 328 mm (525 in)	10 899 mm (429 in)	10 185 mm (401 in)	9981 mm (393 in)	8138 mm (320 in)	7021 mm (276 in)	2093 mm (82 in)	26.0°	24.0°	2536 mm (100 in)
4-wheel steer	20.5 x 25	9797 mm (386 in)	9490 mm (374 in)	6732 mm (265 in)	6061 mm (239 in)	5832 mm (230 in)	4000 mm (157 in)	3498 mm (137 in)	2055 mm (81 in)	25.0°	23.0°	2606 mm (103 in)
	16.0 x 25	9797 mm (386 in)	9490 mm (374 in)	6732 mm (265 in)	6010 mm (237 in)	5806 mm (229 in)	4000 mm (157 in)	3498 mm (137 in)	2093 mm (82 in)	26.0°	24.0°	2536 mm (100 in)

Notes:

- All dimensions are for reference only
- Boom elevation is -3° to +76°
- Dimensions shown are based on 20.5 x 25 tires.
- Add 35.4 mm (1.35 in) for 16.0 x 25 tires

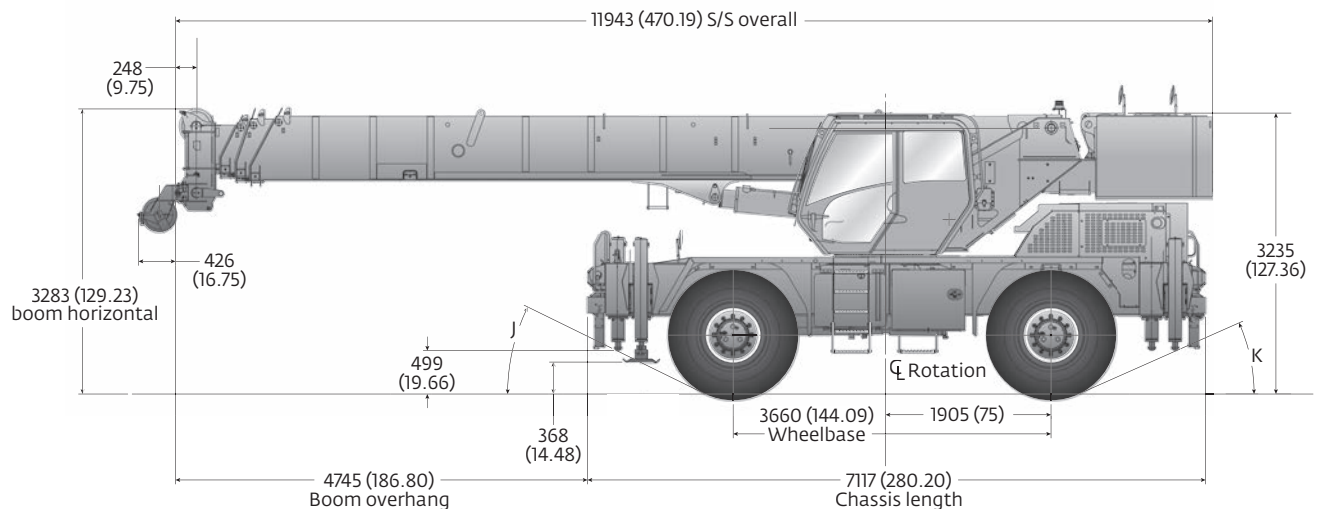
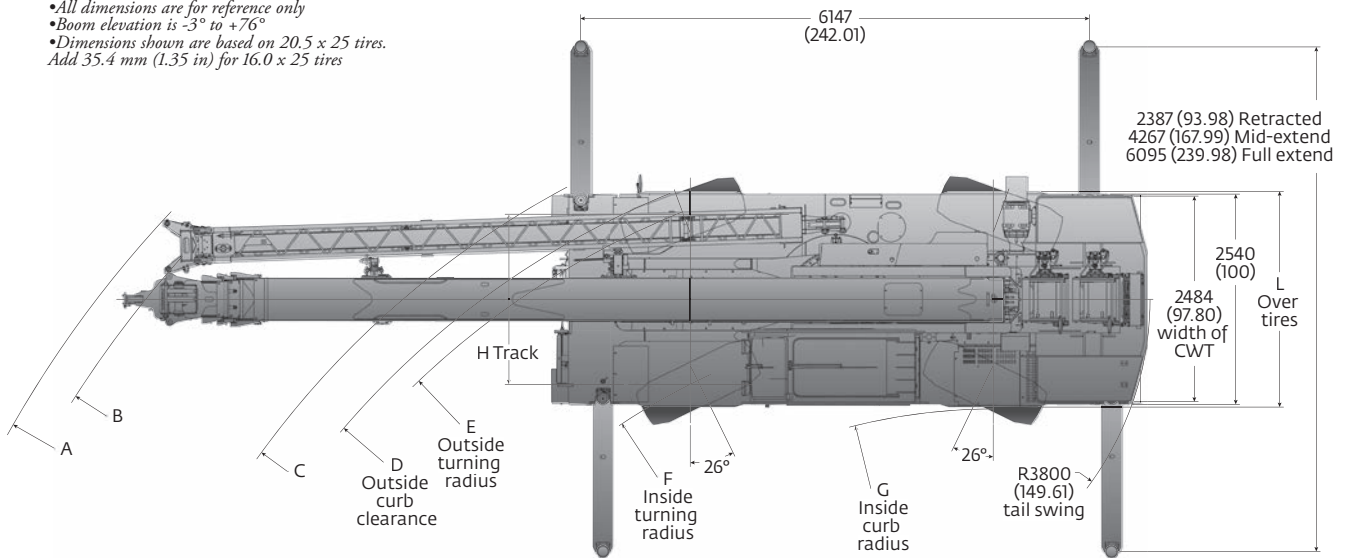

Weights

	Gross		Front		Rear	
	kg	lb	kg	lb	kg	lb
Basic Machine: including 31 m (102 ft) main boom, main hoist with 137 m (450 ft) of rope, full counterweight + IPO, 6.8 t (7.5 USt) headache ball, and 35 t (40 USt) hook block: Tier 4F engine.	27 950	61,618	13 157	29,005	14 793	32,613
Add: Auxiliary hoist + 137 m (450 ft) of 35 x 7 hoist cable and auxiliary boom nose ILO IPO counterweight	28 177	62,118	13 234	29,176	14 942	32,942
Add: 7.9 - 13.7 m (26 ft - 45 ft) telescopic boom extension + extension hangers	29 038	64,016	14 662	32,324	14 375	31,692

Working range

102 ft main boom + 26 ft – 45 ft extension

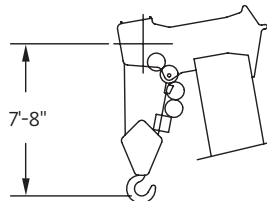
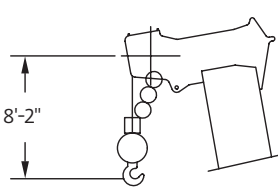
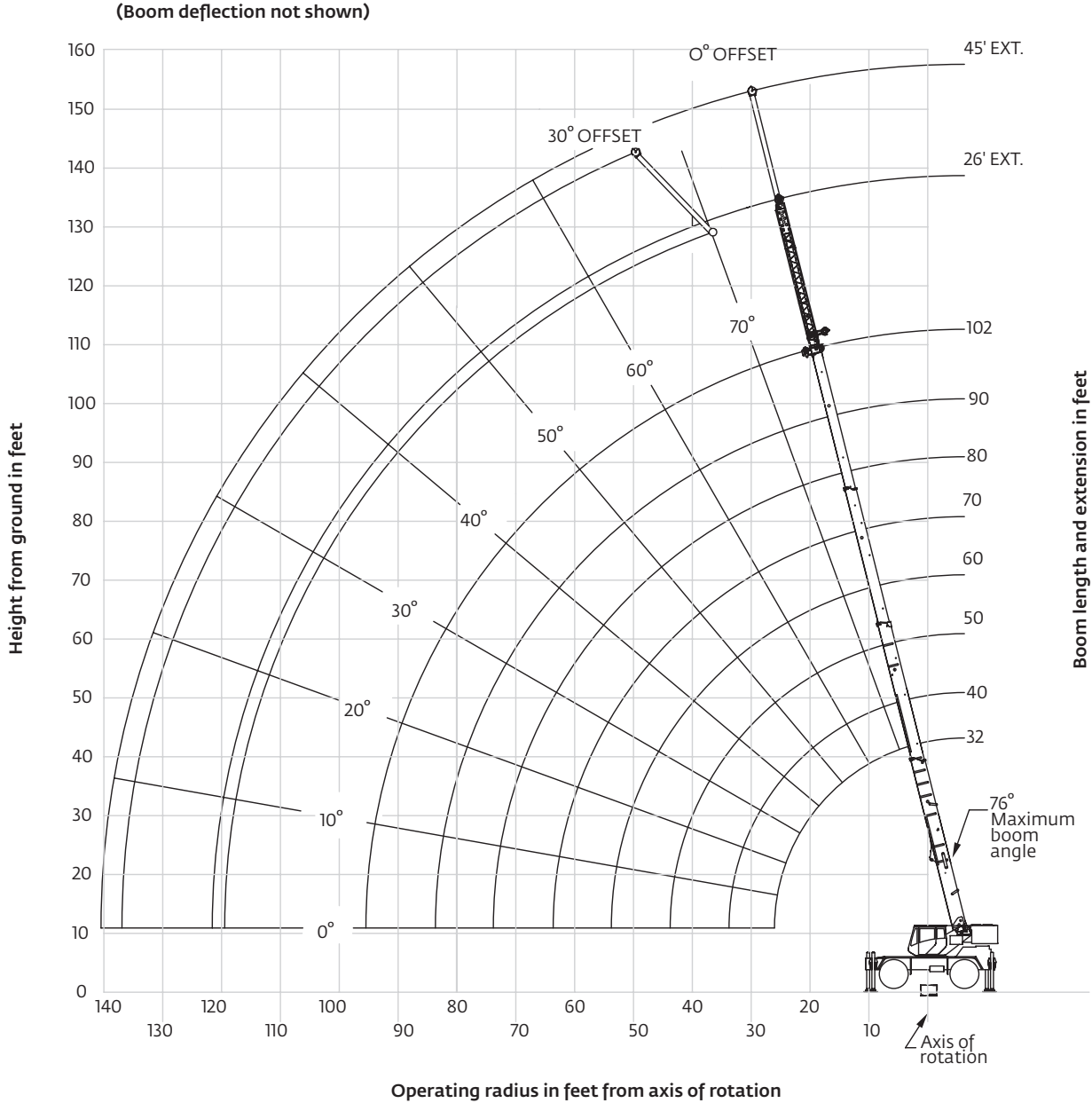

Dimensions are for largest Grove furnished hook block and headache ball, with anti-two block activated.

Load chart



Feet	Main boom length in feet							
	32	40	50	60	70	80	90	102
8	80,000 (69)	—	—	—	—	—	—	—
10	72,200 (65)	50,700 (70.5)	48,500 (75)	—	—	—	—	—
12	61,000 (61)	50,700 (67.5)	48,500 (72.5)	46,400* (76)	—	—	—	—
15	47,950 (54)	48,400 (62.5)	48,500 (69)	44,300 (73)	38,700* (76)	—	—	—
20	34,550 (41)	35,000 (53.5)	35,400 (62.5)	35,300 (67.5)	31,000 (71.5)	29,700 (74)	22,000* (76)	—
25	26,300 (20.5)	26,800 (43.5)	27,200 (55.5)	27,400 (62.5)	25,800 (67)	24,600 (70.5)	22,000 (73)	18,500* (76)
30	—	21,250 (30)	21,650 (47.5)	21,850 (56.5)	25,800 (62.5)	20,800 (66.5)	18,350 (69.5)	17,500 (73)
35	—	—	17,650 (38.5)	17,900 (50.5)	18,050 (57.5)	17,800 (62.5)	15,600 (66)	15,200 (70)
40	—	—	14,400 (26.5)	14,450 (43.5)	14,650 (52.5)	14,800 (58.5)	13,500 (62.5)	13,200 (66.5)
45	—	—	—	11,650 (35)	11,800 (46.5)	11,900 (54)	11,750 (59)	11,600 (63.5)
50	—	—	—	9480 (24.5)	9680 (40.5)	9770 (49)	9780 (55)	9790 (60.5)
55	—	—	—	—	7970 (33)	8080 (44)	8110 (51)	8130 (57)
60	—	—	—	—	6600 (23)	6720 (38)	6770 (46.5)	6800 (53.5)
65	—	—	—	—	—	5590 (31)	5670 (42)	5710 (49.5)
70	—	—	—	—	—	4640 (21.5)	4740 (36)	4800 (45.5)
75	—	—	—	—	—	—	3940 (29.5)	4040 (41)
80	—	—	—	—	—	—	3250 (21)	3360 (36)
85	—	—	—	—	—	—	—	2770 (30.5)
90	—	—	—	—	—	—	—	2250 (23)
95	—	—	—	—	—	—	—	1800 (9.5)
Minimum boom angle (°) for indicated length (no load)								0
Maximum boom length (ft) at 0° boom angle (no load)								102

*This capacity is based on maximum boom angle
NOTE: () Boom angles are in degrees.

Boom angle	Lifting capacities at 0° boom angle							
	32 ft	40 ft	50 ft	60 ft	70 ft	80 ft	90 ft	102 ft
0°	24,950 (26)	18,100 (33.8)	12,150 (43.8)	8180 (53.8)	5740 (63.8)	4030 (73.8)	2800 (83.8)	1760 (95.5)

NOTE: () Reference radii in feet.

A6-829-104278

THIS CHART IS ONLY A GUIDE AND SHOULD NOT BE USED TO OPERATE THE CRANE.
The individual crane's load chart, operating instructions and other instructional plates must be read and understood prior to operating the crane.

Load chart

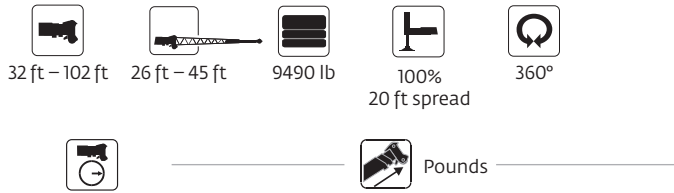

Feet	26 ft length			45 ft length		
	0° offset	15° offset	30° offset	0° offset	15° offset	30° offset
35	10,200* (76)	—	—	—	—	—
40	9460 (72.5)	7770* (76)	—	5250* (76)	—	—
45	8760 (70)	7370 (72)	6030* (76)	5250 (73.5)	—	—
50	8150 (67.5)	6870 (69.5)	5780 (72.5)	5050 (71.5)	3660 (76)	—
55	7510 (65)	6050 (67)	5520 (70)	4650 (69.5)	3540 (72.5)	—
60	6700 (62.5)	5350 (64.5)	5290 (67.5)	4290 (67)	3430 (70.5)	3000* (76)
65	5990 (60)	4740 (62)	4810 (64.5)	4000 (65)	3320 (68.5)	2890 (72.5)
70	5240 (57.4)	4210 (59)	4270 (62)	3800 (63)	3220 (66)	2790 (70.5)
75	4400 (54.5)	3750 (56)	3800 (59)	3650 (60.5)	3130 (64)	2700 (68)
80	3670 (51.5)	3330 (53.5)	3380 (56)	3520 (58.5)	3000 (61.5)	2620 (65.5)
85	3050 (48.5)	2960 (50.5)	3010 (53)	3360 (56)	2880 (59)	2550 (63)
90	2500 (45)	2590 (47)	2670 (49.5)	3030 (53.5)	2770 (56.5)	2480 (60.5)
95	2020 (41.5)	2130 (43.5)	2270 (46)	2640 (51)	2680 (54)	2410 (57.5)
100	1590 (38)	1680 (40)	1790 (41.5)	2270 (48)	2570 (51.5)	2380 (55)
105	1200 (33.5)	1280 (35.5)	1360 (37)	1930 (45.5)	2260 (48.5)	2310 (52)
110	—	—	—	1630 (42.5)	1890 (45.5)	2030 (48.5)
115	—	—	—	1330 (39)	1550 (42)	1700 (45)
120	—	—	—	1040 (35.5)	1240 (38.5)	1400 (41)
125	—	—	—	—	—	1080 (36.5)
Min. boom angle for indicated length (no load)	29°	30.5°	36°	34°	34.5°	35°
Max. boom length at 0° boom angle (no load)	80 ft			80 ft		

NOTE: () Boom angles are in degrees.

*This capacity is based on maximum obtainable boom angle.

A6-829-104322

Boom extension capacity notes:

1. All capacities above the bold line are based on structural strength of boom extension.
 2. 26 ft fixed extension lengths may be used for single line lifting service.
 3. Radii listed are for a fully extended boom with the boom extension erected. For main boom lengths less than fully extended, the rated loads are determined by boom angle. Use only the column which corresponds to the boom extension length and offset for which the machine is configured. For boom angles not shown, use the rating of the next lower boom angle.
- Warning:** Operation of this machine with heavier loads than the capacities listed is strictly prohibited. Machine tipping with boom extension occurs rapidly and without advance warning.
4. Boom angle is the angle above or below horizontal of the longitudinal axis of the boom base section after lifting rated load.
 5. Capacities listed are with outriggers fully extended and vertical jacks set only.
 6. When lifting over the main boom nose with 26 ft fixed extension erected, the outriggers must be fully extended or 50% extended (14 ft spread).

THIS CHART IS ONLY A GUIDE AND SHOULD NOT BE USED TO OPERATE THE CRANE.

The individual crane's load chart, operating instructions and other instructional plates must be read and understood prior to operating the crane.

Load chart

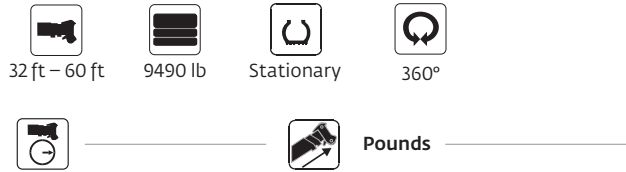

Feet	Main boom length in feet			
	32	40	50	60
10	24,050 (65)	24,100 (70.5)	23,000 (76)	—
12	21,600 (61)	22,050 (50)	21,600 (72.5)	—
15	15,250 (54)	15,550 (62.5)	16,100 (68.5)	13,900 (72.5)
20	9110 (41)	9380 (53.5)	9860 (62)	9860 (67.5)
25	5790 (20)	6050 (43)	6400 (55)	6510 (62)
30	—	3970 (29.5)	4240 (47.5)	4370 (56)
35	—	—	2770 (38)	2900 (50)
40	—	—	1,690 (26)	1840 (43)
45	—	—	—	1030 (34.5)
Min. boom angle for indicated length (no load)				33°
Max. boom length at 0° boom angle (no load)				50 ft

NOTE: () Boom angles are in degrees.

Boom angle	Lifting capacities at 0° boom angle			
	32	40	50	60
0°	5290 (26)	2850 (33.8)	1060 (43.8)	—

NOTE: () Reference radii in feet.

A6-829-104281

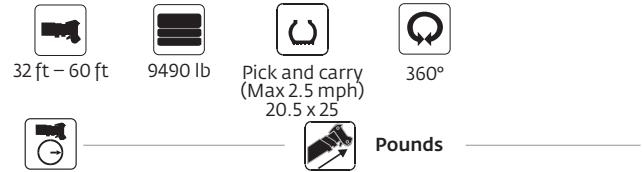

Feet	Main boom length in feet			
	32	40	50	60
10	27,150 (65)	26,900 (70.5)	—	—
12	23,350 (61)	23,350 (67.5)	—	—
15	18,950 (54)	19,100 (62.5)	19,400 (69)	—
20	13,700 (41)	14,200 (53.5)	14,500 (62.5)	14,550 (67.5)
25	10,100 (20)	10,750 (43.5)	11,150 (55.5)	11,200 (62)
30	—	8290 (30)	8620 (47.5)	8790 (56.5)
35	—	—	6710 (38.5)	6890 (50)
40	—	—	5210 (26.5)	5390 (43)
45	—	—	—	4180 (35)
50	—	—	—	3190 (24)
Min. boom angle for indicated length (no load)				0°
Max. boom length at 0° boom angle (no load)				60 ft

NOTE: () Boom angles are in degrees.

Boom angle	Lifting capacities at 0° boom angle			
	32	40	50	60
0°	9520 (26)	6830 (33.8)	4280 (43.8)	2560 (53.8)

NOTE: () Reference radii in feet.

A6-829-104282

Notes to all rubber capacity charts:

- Capacities are in pounds and do not exceed 75% of tipping loads as determined by test in accordance with SAE J765.
- Capacities are applicable to machines equipped with 20.5 x 25 (24 ply) tires at 75 psi cold inflation pressure, and 16.00 x 25 (28 ply) tires at 100 psi cold inflation pressure.
- Capacities appearing above the bold line are based on structural strength and tipping should not be relied upon as a capacity limitation.
- Capacities are applicable only with machine on firm level surface.
- On rubber lifting with boom extensions not permitted.
- For pick and carry operation, boom must be centered over front of machine, mechanical swing lock engaged and load restrained from swinging. When handling loads in the structural range with capacities close to maximum ratings, travel should be reduced to creep speeds.
- Axle lockouts must be functioning when lifting on rubber.
- All lifting depends on proper tire inflation, capacity and condition. Capacities must be reduced for lower tire inflation pressures. See lifting capacity chart for tire used. Damaged tires are hazardous to safe operation of crane.
- Creep – Not over 200 ft of movement in any 30 minute period and not exceeding 1 mph.

THIS CHART IS ONLY A GUIDE AND SHOULD NOT BE USED TO OPERATE THE CRANE.
The individual crane's load chart, operating instructions and other instructional plates must be read and understood prior to operating the crane.

Load chart



Feet	Main boom length in feet							
	32	40	50	60	70	80	90	102
8	77,000 (69)	—	—	—	—	—	—	—
10	66,250 (65)	50,700 (70.5)	48,500 (75)	—	—	—	—	—
12	57,950 (61)	50,700 (67.5)	48,500 (72.5)	46,400* (76)	—	—	—	—
15	46,300 (54)	44,200 (62.5)	41,800 (69)	39,550 (73)	37,550* (76)	—	—	—
20	27,100 (41)	27,700 (53.5)	27,050 (62.5)	25,950 (67.5)	24,950 (71.5)	24,000 (74)	22,000* (76)	—
25	17,650 (20.5)	18,250 (43.5)	18,500 (55.5)	18,450 (62.5)	18,050 (67)	17,450 (70.5)	16,950 (73)	16,350* (76)
30	—	12,850 (30)	13,200 (47.5)	13,300 (56.5)	13,550 (62.5)	13,250 (66.5)	12,950 (69.5)	12,500 (73)
35	—	—	9790 (38.5)	9910 (50.5)	10,150 (57.5)	10,250 (62.5)	10,100 (66)	9830 (70)
40	—	—	7400 (26.5)	7520 (43.5)	7770 (53.5)	7910 (58.5)	7950 (62.5)	7820 (66.5)
45	—	—	—	5760 (35)	5970 (46.5)	6150 (54)	6180 (59)	6190 (63.5)
50	—	—	—	4410 (24.5)	4590 (40.5)	4750 (49)	4820 (55)	4850 (60.5)
55	—	—	—	—	3500 (33)	3630 (44)	3710 (51)	3780 (57)
60	—	—	—	—	2610 (23)	2730 (38)	2810 (46.5)	2890 (53.5)
65	—	—	—	—	—	1980 (31)	2070 (42)	2150 (49.5)
70	—	—	—	—	—	1350 (21.5)	1440 (36)	1530 (45.5)
75	—	—	—	—	—	—	—	1000 (41)
Min. boom angle for indicated length (no load)						0°	21°	36°
Max. boom length at 0° boom angle (no load)						—	80	—

NOTE: () Boom angles are in degrees.
*This capacity is based on maximum obtainable boom angle.

Boom angle	Lifting capacities at 0° boom angle				
	32	40	50	60	70
0°	16,300 (26)	10,150 (33.8)	6030 (43.8)	3580 (53.8)	2050 (63.8)

NOTE: () Reference radii in feet. A6-829-104279

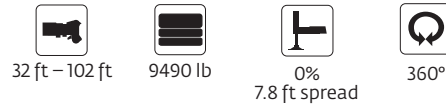

Feet	Main boom length in feet							
	32	40	50	60	70	80	90	102
8	51,950 (69)	—	—	—	—	—	—	—
10	37,800 (65)	35,900 (70.5)	33,600 (75)	—	—	—	—	—
12	29,050 (61)	28,100 (67.5)	26,600 (72.5)	25,150* (76)	—	—	—	—
15	20,850 (54)	20,450 (62.5)	19,750 (69)	18,850 (73)	18,000* (76)	—	—	—
20	12,500 (41)	13,050 (53.5)	12,950 (62.5)	12,600 (67.5)	12,150 (71.5)	11,700 (74)	11,250* (76)	—
25	7950 (20.5)	8460 (43.5)	8700 (55.5)	8760 (62.5)	8580 (67)	8300 (70.5)	8050 (73)	7720* (76)
30	—	5610 (30)	5890 (47.5)	6000 (56.5)	6110 (62.5)	5980 (66.5)	5840 (69.5)	5600 (73)
35	—	—	3980 (38.5)	4090 (50.5)	4350 (57.5)	4270 (62.5)	4200 (66)	4060 (70)
40	—	—	2600 (26.5)	2710 (43.5)	2940 (52.5)	2970 (58.5)	2940 (62.5)	2850 (66.5)
45	—	—	—	1670 (35)	1860 (46.5)	1960 (54)	1950 (59)	1890 (63.5)
50	—	—	—	—	1020 (40.5)	1160 (49)	1160 (55)	1110 (60.5)
Min. boom angle for indicated length (no load)				0°	33°	44°	51°	57°
Max. boom length at 0° boom angle (no load)				—	—	60	—	—

NOTE: () Boom angles are in degrees.
*This capacity is based on maximum obtainable boom angle.

Boom angle	Lifting capacities at 0° boom angle		
	32	40	50
0°	7230 (26)	4060 (33.8)	1790 (43.8)

NOTE: () Reference radii in feet. A6-829-104280

THIS CHART IS ONLY A GUIDE AND SHOULD NOT BE USED TO OPERATE THE CRANE.
The individual crane's load chart, operating instructions and other instructional plates must be read and understood prior to operating the crane.

Load chart

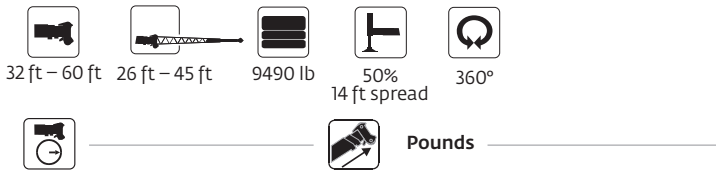

Feet	26 ft length			45 ft length		
	0° offset	15° offset	30° offset	0° offset	15° offset	30° offset
35	9120* (76)	—	—	—	—	—
40	7240 (72.5)	7770* (76)	—	*5250 (76)	—	—
45	5780 (70)	6460 (72)	6030* (76)	5250 (73.5)	—	—
50	4610 (67.5)	5200 (69.5)	5740 (72.5)	5050 (71.5)	3660 (76)	—
55	3650 (65)	4180 (67)	4650 (70)	4280 (69.5)	3540 (72.5)	—
60	2850 (62.5)	3320 (64.5)	3720 (67.5)	3480 (67)	3430 (70.5)	3000* (76)
65	2140 (60)	2550 (62)	2900 (64.5)	2820 (65)	3320 (68.5)	2890 (72.5)
70	1540 (57.5)	1900 (59)	2210 (62)	2260 (63)	2880 (66)	2790 (70.5)
75	1030 (54.5)	1350 (56)	1620 (59)	1740 (60.5)	2300 (64)	2700 (68)
80	—	—	1100 (56)	1300 (58.5)	1800 (61.5)	2240 (65.5)
85	—	—	—	—	1360 (59)	1750 (63)
90	—	—	—	—	—	1320 (60.5)
Min. boom angle for indicated length (no load)	51.5°	53.5°	53°	56°	56.5°	57.5°
Max. boom length at 0° boom angle (no load)	60 ft			60 ft		

NOTE: () Boom angles are in degrees.

A6-829-104323

*This capacity is based on maximum obtainable boom angle.

Boom extension capacity notes:

1. All capacities above the bold line are based on structural strength of boom extension.
 2. 26 ft and 45 ft tele extension lengths may be used for single line lifting service.
 3. Radii listed are for a fully extended boom with the boom extension erected. For main boom lengths less than fully extended, the rated loads are determined by boom angle. Use only the column which corresponds to the boom extension length and offset for which the machine is configured. For boom angles not shown, use the rating of the next lower boom angle.
- Warning:** Operation of this machine with heavier loads than the capacities listed is strictly prohibited. Machine tipping with boom extension occurs rapidly and without advance warning.
4. Boom angle is the angle above or below horizontal of the longitudinal axis of the boom base section after lifting rated load.
 5. Capacities listed are with outriggers properly extended and vertical jacks set only.
 6. When lifting over the main boom nose with 26 ft fixed extension erected, the outriggers must be fully extended or 50% extended (14 ft spread).

THIS CHART IS ONLY A GUIDE AND SHOULD NOT BE USED TO OPERATE THE CRANE.

The individual crane's load chart, operating instructions and other instructional plates must be read and understood prior to operating the crane.

Load handling

Weight reductions for load handling devices	
26 ft – 45 ft telescopic boom extension	lb
Erected (retracted)*	3750
Erected (extended)*	5010
Auxiliary boom nose	lb
	105
Hook blocks and headache balls	lb
40 USt, 4-sheave	774 +
40 USt, 3-sheave	600 +
33 USt, 3-sheave	644 +
20 USt, single sheave	410 +
7.5 USt, overhaul ball	370+

* Reduction of main boom capacities
+ Refer to rating plate for actual weight

When lifting over swingaway and/or jib combinations, deduct total weight of all load handling devices reeved over main boom nose directly from swingaway or jib capacity.

NOTE: All load handling devices and boom attachments are considered part of the load and suitable allowances MUST BE MADE for their combined weights. Weights are for Grove furnished equipment.

Capacity reductions for synthetic rope use:		
	Main boom charts	Extension charts
Outriggers fully extended	100 lb	0 lb
Outriggers 50% extended	470 lb	140 lb
Outriggers 0% extended	600 lb	N/A
On Rubber	200 lb	N/A

If synthetic rope is installed on either the main or aux hoist, and wire rope is installed on the other hoist, no capacity reductions are required.

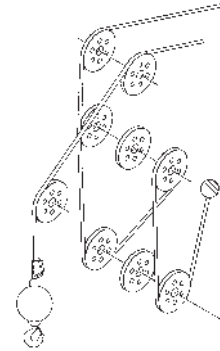

Line pulls and reeving information			
Hoists	Cable specs	Permissible line pulls	Nominal cable length
Main	16 mm (5/8 in) 6 x 37 class EIPS, IWRC Special Flexible Min. Breaking Str. 41,200 lb	11,640 lb*	450 ft
Main and auxiliary	16 mm (5/8 in) EEIPS Rotation resistant (non-rotating) Min. breaking Str. 61,200 lb	11,640 lb*	450 ft
Main and auxiliary	18 mm (11/16 in) K™-100 Synthetic hoist rope (ISO) Min. breaking strength 63,700 lb	12,740 lb*	463 ft

The approximate weight of 5/8 in wire rope is 1.0 lb/ft. The approximate weight of 18 mm synthetic rope is 0.16 lb/ft. *With certain boom and hoist tackle combinations, the allowable line pull may be limited by hoist performance. Refer to Hoist Performance table for lift planning to ensure adequate hoist performance on drum rope layer required.

Hoist performance				
Wire rope layer	Hoist line pulls two-speed hoist		Drum rope capacity (ft)	
	Low available lb*	High available lb*	Layer	Total
1	11,640	7420	77	77
2	10,480	6680	85	162
3	9530	6070	94	256
4	8730	5570	102	358
5	8060	5140	111	469
6	7490	4770	119	588

* Max lifting capacity: 6 x 37 class = 11,640 lb
35 x 7 class = 11,640 lb

Working area diagram

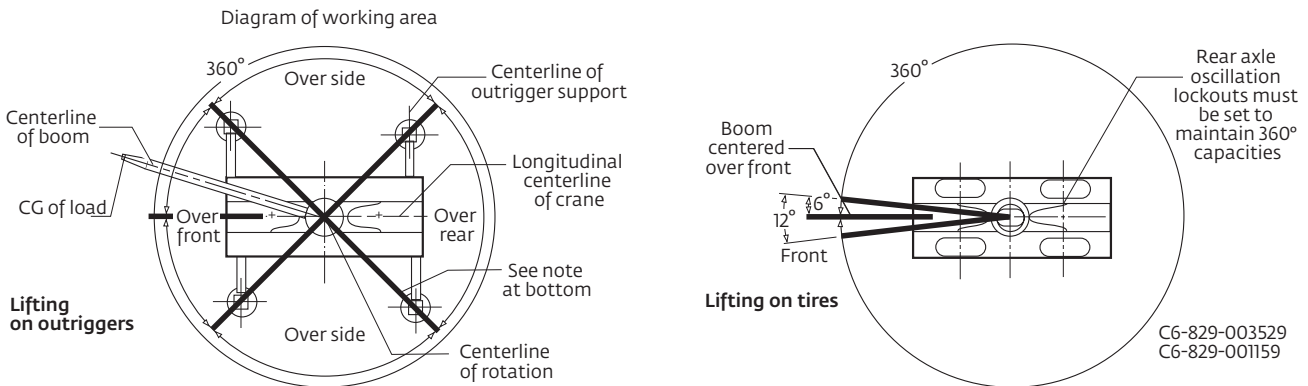

Bold lines determine the limiting position of any load for operation within working areas indicated.

Superstructure



Boom

9,8 m – 31 m (32 ft – 102 ft) four-section, synchronized full-power boom.
Maximum tip height: 33,6 m (110 ft).



*Optional telescopic swingaway extension
7,9 m – 13,7 m (26 ft – 45 ft) offsettable telescopic lattice swingaway extension. Offsets at 0°, 15° and 30°. Stows alongside base boom section.
Maximum tip height 47 m (154 ft).



Boom nose

Four nylatron sheaves mounted on heavy duty tapered roller bearings with removable pin-type rope guards. Quick reeve type boom nose.



Boom elevation

One double-acting hydraulic cylinder with integral holding valve provides elevation from -3° to +76°.



Crane Control System (CCS)

“Graphic Display” RCL load moment and anti-two block system with audio-visual warning and control lever lockout. This system provides electronic display of boom angle, boom length, load radius, boom tip height, maximum permissible load, actual load and warning of impending two-block condition. The work area definition system allows the operator to pre-select and define safe working areas. If the crane approaches the pre-set limits, audio-visual warnings aid the operator in avoiding job site obstructions. ECO mode system to control engine R.P.M. to lower noise and improve fuel consumption.



Cab

Full-vision, all-steel fabricated with acoustical lining and tinted safety glass throughout. Adjustable deluxe seat incorporates armrest-mounted electronic single or dual axis controllers and a jog dial for easier data input. Tilt/telescoping steering wheel with various controls incorporated into the steering column. Other standard features include hot water heater, cab circulating air fan, sliding side and rear windows, sliding skylight with electric wiper and sunscreen, electric windshield wash/wipe, fire extinguisher, seat belt, air conditioning and dual cab mounted work light.



Swing

Variable speed, planetary swing drive with foot applied multi-disc wet brake. Spring applied, hydraulically released swing brake. Single position mechanical house lock, operated from cab.
Maximum speed: 2 rpm.



Counterweight

4305 kg (9490 lb) pinned to superstructure.



Hydraulic system

Two main pumps, one (1) piston and one (1) gear with a combined capacity of 316,5 L/min (83.6 gpm). Maximum operating pressure: 275,7 bar (4000 psi). Three section pressure compensated valve bank. Return line type filter with full flow by-pass protection and service indicator. Replaceable cartridge with micron filtration rating of 5/12/16. 396 L (104.6 gal) hydraulic reservoir. System pressure test ports.



Hoist (main and optional auxiliary hoist)

Planetary reduction with automatic spring applied multi-disk wet brake. Electronic hoist drum rotation indicators, and hoist drum cable followers.

Hoist maximum single line pull:

1st layer: 5280 kg (11,640 lb)

3rd layer: 4323 kg (9530 lb)

5th layer: 3656 kg (8060 lb)

Maximum permissible line pull:

5280 kg (11,640 lb) with 35 x 7 class rope

Maximum single line speed: 136 m/min (445 fpm)

Rope construction:

35 x 7 Rotation Resistant

Rope diameter: 16 mm (5/8 in)

Rope length:

Main hoist: 137 m (450 ft)

Auxiliary hoist: 137 m (450 ft)

Maximum rope stowage: 181 m (596 ft)

Carrier



Chassis

Box section frame fabricated from high strength, low alloy steel. Front / rear combination lift / tie-down / towing lugs.



Outrigger system

Four hydraulic telescoping single-stage double box beam outriggers with inverted jacks and integral holding valves. Three position setting, 0%, 50% and fully extended. All steel fabricated quick release type outrigger floats, 362 mm (14.25 in) square.

Maximum outrigger pad load 26,762 kg (59,000 lb).

Outrigger monitoring system with outrigger beam position display on R.C.L. screen (required in North America, Canada, and European Union countries).



Outrigger controls

Controls and crane level indicator located in cab. Extension and retraction are through the CCS system.



Engine (Tier 4F)

Cummins QSB 6.7 L diesel, six cylinders, turbo-charged with Cummins Compact Catalyst (CCC) & selective catalytic reduction (SCR) combo muffler, using diesel exhaust fluid (DEF) injection. Meets emission per U.S. Tier 4F and E.U. Stage IV. 122 kW (164 bhp) at 2300 rpm. Maximum torque: 732 Nm (540 ft-lb) at 1500 rpm.

Fuel requirement: Maximum of 15 ppm sulfur content (ultra-low sulfur diesel fuel) and diesel exhaust fluid (DEF).

Note: Tier 4F Engine required in North American, Canada, and European Union countries.

* Denotes optional equipment

Specifications

Carrier *(cont'd)*



Engine (Tier 3)

Cummins QSB 6.7 L diesel, six cylinders, 119 kW (160 bhp) at 2500 rpm.

Maximum torque: 731 Nm (539 ft-lb) at 1500 rpm.



Fuel tank capacity

220 L (58 gal)



Transmission

Rangeshift with six forward and six reverse speeds. (Three speeds high and three speeds low). Front axle disconnect for 4 x 2 drive. l.



Electrical system

Two 12 V maintenance free batteries. 24 V starting and lighting.

Battery disconnect.



Drive

4 x 4



Steering

Fully independent power steering.

Front: Full hydraulic steering wheel controlled.

Rear: Full hydraulic switch controlled.

Provides infinite variations 4-main steering modes: front only, rear only, crab and coordinated.

Rear steer indicator.

Outside turning radius: 5,8 m (19.1 ft)

Inside turning radius: 4 m (13.1 ft)



Axles

Front: Drive/steer with differential and planetary reduction hubs rigid mounted to frame.

Rear: Drive/steer with differential and planetary reduction hubs pivot mounted to frame.



Oscillation lockouts

Automatic full hydraulic lockouts on rear axle permits 18,8 cm (7 in) oscillation only with boom centered over the front.



Brakes

Full hydraulic split circuit disc-type brakes operating on all wheels. Spring-applied, hydraulically released parking brake mounted on front axle.



Tires

Standard 20.5 x 25-24 bias ply



Lights

Full lighting including turn indicators, head, tail, brake and hazard warning lights.



Maximum speed

40 km/h (25 mph) at 2500 rpm



Gradeability (theoretical)

119% (at engine stall).

(Based on 29 038 kg [64,016 lb] GVW) 20.5 x 25 tires 31 m (102 ft) main boom, plus 13,7 m (45 ft) telescopic swingaway, 4305 kg (9490 lb) counterweight, 35 t (40 US t) hook block and 6,8 t (7.5 US t) headache ball.

Miscellaneous standard equipment

























Full width steel fenders, full length steel decking with anti-skid, dual rear view mirrors, hook block tie-down, electronic back-up alarm, light package, front stowage well, tachometer/hour meter, rear wheel position indicator, hot water cab heater, air conditioning, hoist mirrors, engine distress A/V warning system, combination lift/tie-down/towing lugs, coolant sight level indicator.

*Optional equipment

- Auxiliary Hoist Package: Includes auxiliary hoist with electronic hoist drum rotation indicator, hoist drum cable follower, 137 m (450 ft) of 16 mm (5/8 in) 35 x 7 class wire rope and auxiliary sheave boom nose.
- Auxiliary Light and Convenience Package: Includes cab mounted amber flashing light, dual base boom mounted halogen floodlights, LMI light bar (in cab) and rubber mat for stowage trough.
- 360° NYC style mechanical swing lock
- Rear pintle hook
- Cab-controlled cross axle differential locks (front and rear)
- Single axis electric controllers
- Third wrap indicator with hoist cut-out for main and auxiliary hoist
- Vertical RCL light tower (external mounted)
- Synthetic rope for main and/or auxiliary hoist
- Emergency stop buttons on each side of carrier
- Second beacon light
- -29°C / -20°F cold weather package
- -40°C / -40°F arctic weather package
- CraneSTAR asset management system

* Denotes optional equipment

Symbols glossary

 Axles	 Crane control system	 Heavy duty jib	 Outriggers
 Boom	 Drive	 Height (no max)	 Radius
 Boom elevation	 Electrical system	 Hoist	 Rotation
 Boom extension	 Engine	 Hook block	 Speed
 Boom length	 Extension	 Hydraulic system	 Steering
 Boom nose	 Frame	 Insert	 Suspension
 Brakes	 Fuel tank capacity	 Lights	 Swing
 Cab	 Gear	 Oil	 Tires
 Counterweight	 Grade	 Outrigger controls	 Transmission

Manitowoc Cranes

Regional headquarters

Americas

Milwaukee, Wisconsin, USA
Tel: +1 414 760 4600

Shady Grove, Pennsylvania, USA
Tel: +1 717 597 8121

Europe and Africa

Dardilly, France - TOWERS
Tel: +33 (0) 4 72 18 20 20

Wilhelmshaven, Germany - MOBILE
Tel: +49 (0) 4421 294 0

APAC

Shanghai, China
Tel: +86 21 6457 0066

Singapore
Tel: +65 6264 1188

Middle East and India

Dubai, UAE
Tel: +971 4 8862677



This document is non-contractual. Constant improvement and engineering progress make it necessary that we reserve the right to make specification, equipment, and price changes without notice. Illustrations shown may include optional equipment and accessories and may not include all standard equipment.