



TEREX

MAXIM

1-877-MAX-LIFT

Rough Terrain Crane Specifications | RT600 Series

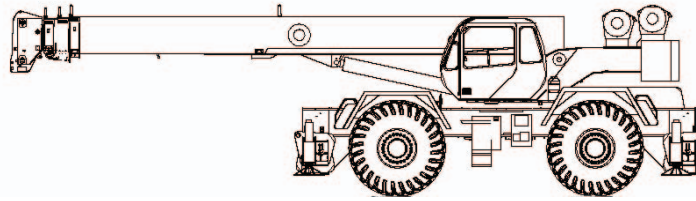

STANDARD BOOM EQUIPMENT

BOOM

36-111' (10.67-33.53 m), four section full power boom. Telescoping is mechanically synchronized with single lever control. The synchronization system consists of a single telescope cylinder and high strength leaf chains to extend and retract the third section and the tip section. The boom is a high-strength four plate design, welded inside and out with anti-friction slide pads. Boom side plates are made with stamped impressions to reduce weight and increase strength. A single boom hoist cylinder provides for boom elevation of -4 to 76 degrees. Maximum tip height 115' (35.05 m).

BOOM HEAD

Welded to fourth section of boom. Five or six nylon load sheaves and two idler sheaves mounted on heavy duty, anti friction bearings. Quick reeving boom head. Provisions made for side-stow jib mounting.

OPTIONAL BOOM EQUIPMENT

JIBS

32' (9.68 m) side stow swing-on one-piece lattice type jib. Single nylon sheave mounted on anti-friction bearing. Jib is offsettable at 0°, 15° or 30°. Maximum tip height is 146' (44.50 m).

33-57' (10.15-17.30 m) side stow swing-on lattice type jib. Single nylon sheave mounted on anti-friction bearing. Jib is extendible to 57' (17.30 m) by means of a 25' (7.62 m) manual pull-out tip section, roller supported for ease of extension. Jib is offsettable at 0°, 15°, 30°. Maximum tip height is 170' (51.82 m).

AUXILIARY BOOM HEAD

Removable auxiliary boom head has single nylon sheave mounted on anti-friction bearing. Removable pin-type rope guard for quick reeving. Installs on main boom peak only. Removal is not required for jib use.

HOOK BLOCK

Five metallic sheaves on anti-friction bearings with hook and hook latch. Quick reeving design does not require removal of wedge and socket form rope.

HOOK AND BALL

12 ton (10.9 mt) top swivel ball with hook and hook latch.

STANDARD UPPERSTRUCTURE EQUIPMENT
UPPERSTRUCTURE FRAME

All welded one-piece structure fabricated with high tensile strength alloy steel. Counterweight is bolted to frame.

TURNTABLE CONNECTION

Swing bearing is a single row, ball type with internal teeth. The swing bearing is bolted to the revolving upperstructure and to the carrier frame.

SWING

A hydraulic motor drives a double planetary reduction gear for precise and smooth swing function. Swing speed (no load) is 1.9 rpm.

SWING BRAKE

Heavy duty multiple disc swing brake is mechanically actuated from operator's cab by foot pedal. Brake may be locked on or used as a momentary brake. A 360° house mechanical house lock is standard.

RATED CAPACITY INDICATOR

Rated Capacity Indicator with visual and audible warning system and automatic function disconnects. Second generation pictographic display includes: boom radius, boom angle, boom length, allowable load, actual load, and percentage of allowable load registered by bar graph. Operator settable alarms provided for swing angle, boom length, boom angle, tip height, and work area exclusion zone. Anti-two block system includes audio/visual warning and automatic function disconnects.

OPERATORS CAB

Environmental cab with all steel construction, optimum visibility, tinted safety glass throughout, and rubber floor matting is mounted on vibration absorbing pads. The cab has a sliding door on the left side. Framed sliding window on the right side, hinged tinted all glass skylight and removable front windshield to provide optimum visibility of the load open or closed. Acoustical foam padding insulates against sound and weather. The deluxe six-way adjustable seat is equipped with a mechanical suspension and includes head and arm rests.

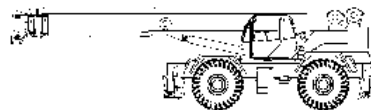
CONTROLS

Armrest mounted dual axis controls for winch(s), swing, and boom elevation. Winch rotation indication incorporated into control handles. Armrest swings up to improve access and egress. Vernier adjustable hand throttle included. Steering column mounted turn signal, wiper, and shift controls. Switches include ignition, engine stop, lights, horn, roof window wiper, defroster, steering mode, parking brake, outriggers, 360° house lock, etc. Horn and winch speed shift switches are mounted in the levers. Foot control pedals include swing brake, boom telescope, service brake, and accelerator.

INSTRUMENTATION AND ACCESSORIES

In-cab gauges include air pressure, bubble level, engine oil pressure, fuel, engine temperature, voltmeter, transmission temperature, and transmission oil pressure. Indicators include low air, high water temperature, low oil pressure, high transmission temperature, and low coolant level audio/visual warning, hoist drum rotation indicator(s), and Rated Capacity Indicator. Accessories include fire extinguisher; light package including headlights, tail light, brake lights, directional signals, four-way hazard flashers, dome light, and back-up lights with audible back-up alarm; windshield washer/wiper; skylight wiper; R.H. and L.H. rear view mirrors; dash lights; and seat belt. Circuit breakers protect electrical circuits.

HYDRAULIC CONTROL VALVES

Valves are mounted on the rear of the upperstructure and are easily accessible. Valves have electric/hydraulic operators and include one pressure compensated two spool valve for main and auxiliary winch, and one single spool valve for swing. Quick disconnects are provided for ease of installation of pressure check gauges.

OPTIONAL EQUIPMENT

Auxiliary Winch, Single axis armrest mounted controllers CLP Heater/Defroster, Hydraulically powered Air conditioner with or without hydraulic header, Diesel Heater/ Defroster, Work Lights, Rotating Beacon.

STANDARD CARRIER EQUIPMENT
CARRIER CHASSIS

Chassis is Terex designed with four-wheel drive and four-wheel steer (4x4x4). Has box-type construction with reinforcing cross members, a precision machined turn table mounting plate and integrally welded outrigger boxes. Decking has anti-skid surfaces, including between the frame rails lockable front tool storage compartment, and access steps and handles on the left and right sides and on all four corners.

AXLES AND SUSPENSION

Rear axle is a planetary drive/steer type with 10.5' (.26 m) of total oscillation. Automatic oscillation lockouts that engage when the superstructure is swung 10° in either direction. Front axle is a planetary drive/steer type, rigid mounted to the frame for increased stability.

STEERING

Hydraulic four-wheel power steering for two-wheel, four-wheel coordinated, or four-wheel crab steer is easily controlled by steering wheel. A rear axle centering light is provided.

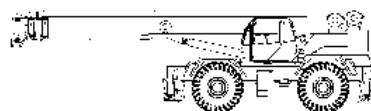
TRANSMISSION

Range shift type power-shift transmission with integral torque converter provides six speeds forward and six speed reverse with neutral safety start. Four wheel drive engages automatically with low range and two wheel drive with high range. Automatic pulsating back-up alarm.

	Turning Radius: (to CL of outside tire)	Curb Clearance Radius
Two-wheel:	41' 7" (12.7 m)	43' 2" (13.2 m)
Four-wheel:	22' 10" (7.0 m)	24' 7" (7.5 m)



ROUGH TERRAIN CRANE RT600 SERIES

STANDARD CARRIER EQUIPMENT (CONTINUED)

MULTI-POSITION OUT AND DOWN OUTRIGGERS

Fully independent hydraulic outriggers may be utilized fully extended to 24' (7.32 m) centerline to centerline, in their 1/2 extended position, or fully retracted for maximum flexibility. Easily removable Almag floats, each with an area of 254 in² (1639 cm²), stow on the outrigger boxes at their point of use. Complete controls and a sight leveling bubble are located in the operator's cab.

WHEELS AND TIRES

Disc type wheels with full tapered bead seat rim. 157.56" (4 m) wheelbase.

TIRES

Wide earthmover (E3) style tread tires provide life and flotation. 29.50 x 25, 28 P.R.-std.

SERVICE BRAKES

Split system air over hydraulic 18.5" (470 mm) diameter disc dual caliper brakes on all wheels.

PARKING BRAKE

Front axle equipped with spring-set, air released parking brake.

OPTIONAL EQUIPMENT

Immersion Heater, Pintle Hook, Clearance Lights, Independent Rear Wheel Steer, Four Mode Rear Wheel Steer, 20,000 lb line pull front mounted winch.

HYDRAULIC SYSTEM

HYDRAULIC PUMPS

Three gear type pumps, one single and two in tandem, driven off the transmission. Combined system capability is 113 gpm (428 lpm). Includes pump disconnect on winch pump.

Main and Auxiliary Winch Pump

▶ 52.7 gpm (199.5 lpm) @ 4,500 psi (316.4 kg/cm²)

Boom Hoist and Telescope Pump

▶ 37.3 gpm (141.2 lpm) @ 3,500 psi (246.1 kg/cm²)

Power Steering, Outrigger and Swing Pump

▶ 18.7 gpm (70.8 lpm) @ 3,500 psi (246.1 kg/cm²)

FILTRATION

Full flow oil filtration system with bypass protection includes a removable 60 mesh (250 micron) suction screen-type filter and five micron replaceable return line filter.

HYDRAULIC RESERVOIR

All steel, welded construction with internal baffles and diffuser. Provides easy access to filters and is equipped with an external sight level gauge. The hydraulic tank is pressurized to aid in keeping out contaminants and in reducing potential pump cavitation. Capacity is 116 gal (439 L). Hydraulic oil cooler is standard.

MAIN WINCH SPECIFICATIONS

Hydraulic winch with bent axis piston motor and planetary reduction gearing provides two-speed operation with equal speeds for power up and down. Winch is equipped with an integral automatic brake, grooved drum, tapered flanges, standard cable roller on drum, and electronic rotation indicator.

Performance	LO-Range	HI-Range
▶ Max line speed (no load)		
▶ First layer	187 fpm (57 m/min)	300 fpm (91.4 m/min)
▶ Fifth layer	269 fpm (82 m/min)	431 fpm (131.4 m/min)
▶ Max. line pull-first layer	18,450 lb (8 369 kg)	10,002 lb (4 537 kg)
▶ Max. line pull-fifth layer	12,845 lb (5 826 kg)	6,963 lb (3 158 kg)
▶ Permissible line pull	13,800 lb (6 260 kg)	

Drum Dimensions

- ▶ 13" (330 mm) drum diameter
- ▶ 20.16" (512 mm) length
- ▶ 12.5" (546 mm) flange dia.
- ▶ Cable: 3/4" x 600' (19 mm x 182.9 m)
- ▶ Cable type: 3/4" (19 mm) 6 x 19 IWRC XIPS, right regular lay, performed.
- ▶ Min. breaking strength 29.4 tons (26.6 mt)

Drum Capacity

Max. Storage: 561' (171 m)
Max. Useable: 561' (171 m)*

*Based on minimum flange height above top layer to comply with ANSI B30.5

OPTIONAL AUXILIARY WINCH

Hydraulic two-speed winch with bent axis piston motor, equal speed power up and down, planetary reduction with integral automatic brake, grooved drum with tapered flanges, drum roller, and rotation indicator.

Performance

- ▶ Max. line speed (no load) Fifth layer 431 fpm (131.4 m/min)
- ▶ Max. line pull First layer 18,450 lb (8 369 kg)

Drum Dimensions and Capacity

(Same as main winch)

OPTIONAL HOIST LINE

Main winch and optional auxiliary winch 3/4" (19 mm) rotation resistant compacted strand 34 x 7 grade 1960. Min. breaking strength 34.5 tons (31.7 mt).

ENGINE SPECIFICATIONS

- ▶ Make and Model, Cummins QSB-215 (300 hp)
- ▶ Type 6 cylinder
- ▶ Bore and Stroke 4.02 x 4.72" (102 x 120 mm)
- ▶ Displacement 359 in³ (5.9 L)
- ▶ Rated HP 215 hp (160 kw) @ 2500 rpm
- ▶ Max. Gross HP 255 hp (168 kw) @ 2300 rpm
- ▶ Max. Gross Torque 655 lb • ft (888 N•m) @ 1500 rpm
- ▶ Aspiration Turbocharged & charge air cooled
- ▶ Air filter dry type
- ▶ Electrical System 12 volt
- ▶ Alternator 102 amp
- ▶ Battery (2) 12V-1900 C.C.A.
- ▶ Fuel Capacity 50 gal (189 L)

PERFORMANCE (STANDARD ENGINE)

Trans- mission Gear	Forward Drive	Max. Speed	Max. Tractive Effort	Grade- ability @ Stall
▶ 1	4-wheel	1.9 mph (3.1 kph)	86,330 lb (39 159 kg)	127.6%
▶ 2	4-wheel	3.8 mph (6.1 kph)	41,547 lb (18 845 kg)	48.5%
▶ 3	4-wheel	9.6 mph (15.4 kph)	15,220 lb (6 904 kg)	34.7%
▶ 4	2-wheel	5.2 mph (8.4 kph)	29,686 lb (13 465 kg)	18%
▶ 5	2-wheel	10.3 mph (16.6 kph)	14,260 lb (6 468 kg)	12%
▶ 6	2-wheel	23.4 mph (37.7 kph)	5,211 lb (2 364 kg)	5.9%

All performance data is based on a gross vehicle weight of 86,000 lb (39 009 kg) 29.5x25 tires, 4x4 drive. Performance may vary due to engine performance. Gradeability data is theoretical and is limited by tire slip, machine stability, or oil pan design.



GENERAL DIMENSIONS

- Dimensions given assume the boom is fully retracted in travel position and 29.50 x 25 tires.
- Minimum ground clearance under: transmission-29.00", axle bowls-23.62", tie rods-23.88"

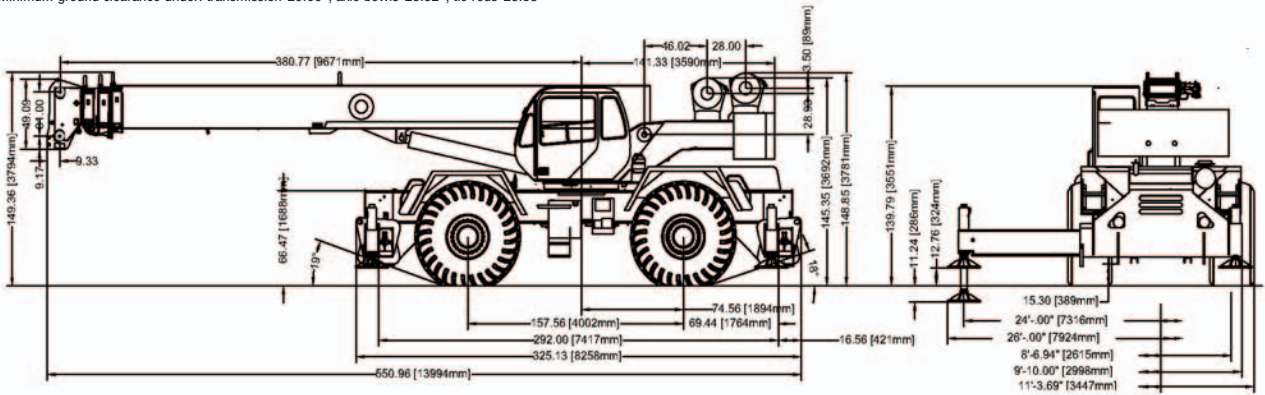

WEIGHTS & AXLE LOADS	GROSS WEIGHT LB	UPPER FACING FRONT		GROSS WEIGHT KG	UPPER FACING FRONT	
		FRONT	REAR		FRONT	REAR
Basic crane with 14,200 lb (6 440 kg) counterweight	85,694	45,238	40,456	38 870	20 520	18 350
Add Options:						
32' (9.68 m) Swing-on Jib (Stowed)	+ 1,270	+ 2,205	- 935	+ 576	+ 1 000	- 424
33'-57' (10.15-17.30 m) Swing-on Jib (Stowed)	+ 2,170	+ 3,580	- 1,410	+ 984	+ 1 624	- 640
Axillary Boom Head	+ 125	+ 365	- 240	+ 57	+ 166	- 109
Auxiliary Winch with Wire Rope, Controls, Etc.	+ 584	- 30	+ 614	+ 265	- 14	+ 279
75 T (68.0 mt) 5-Sheave Hook Block	+ 1,040	+ 1,971	- 931	+ 472	+ 894	- 422
60 T (54.4 mt) 5-Sheave Hook Block	+ 1,204	+ 2,233	- 1,029	+ 546	+ 1 013	- 467
20 T (18.1 mt) I-Sheave Hook Block	+ 570	+ 936	- 366	+ 259	+ 425	- 166
12 T (19.9 mt) Hook and Ball (In tool box)	+ 419	+ 443	- 24	+ 190	+ 201	- 11
Pintle Hook:						
Front	+ 45	+ 60	- 15	+ 20	+ 27	- 7
Rear	+ 45	- 25	+ 70	+ 20	- 11	+ 31
Substitute:						
600' of 34x7 class spin resistant wire rope	+ 98	- 17	+ 115	+ 44	- 8	+ 52

Note: Weights are for Terex supplied equipment and are subject to 2% variation due to manufacturing tolerances.

TEREX Cranes
106-12th Street S.E.
Waverly, Iowa 50677-9466 USA

TEL (319) 352-3920 FAX (319) 352-5727
EMAIL inquire@terexwaverly.com
WEB terex.com

Range Diagram and Lifting Capacity | RT665

65 TON LIFTING CAPACITY

RANGE DIAGRAM 36' - 111' BOOM

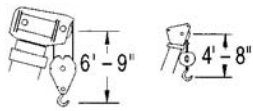

DIMENSIONS ARE FOR LARGEST FACTORY FURNISHED HOOK BLOCK AND HOOK & BALL, WITH ANTI-TWO BLOCK ACTIVATED

COUNTERWEIGHT	W/AUX. WINCH 13,100 LB W/O AUX. WINCH 14,200 LB
BOOM LENGTH	36'-111'
OUTRIGGER SPREAD	24'
STABILITY PERCENTAGE	ON OUTRIGGERS 85% ON TIRES 75%
PCSA CLASS	10-270

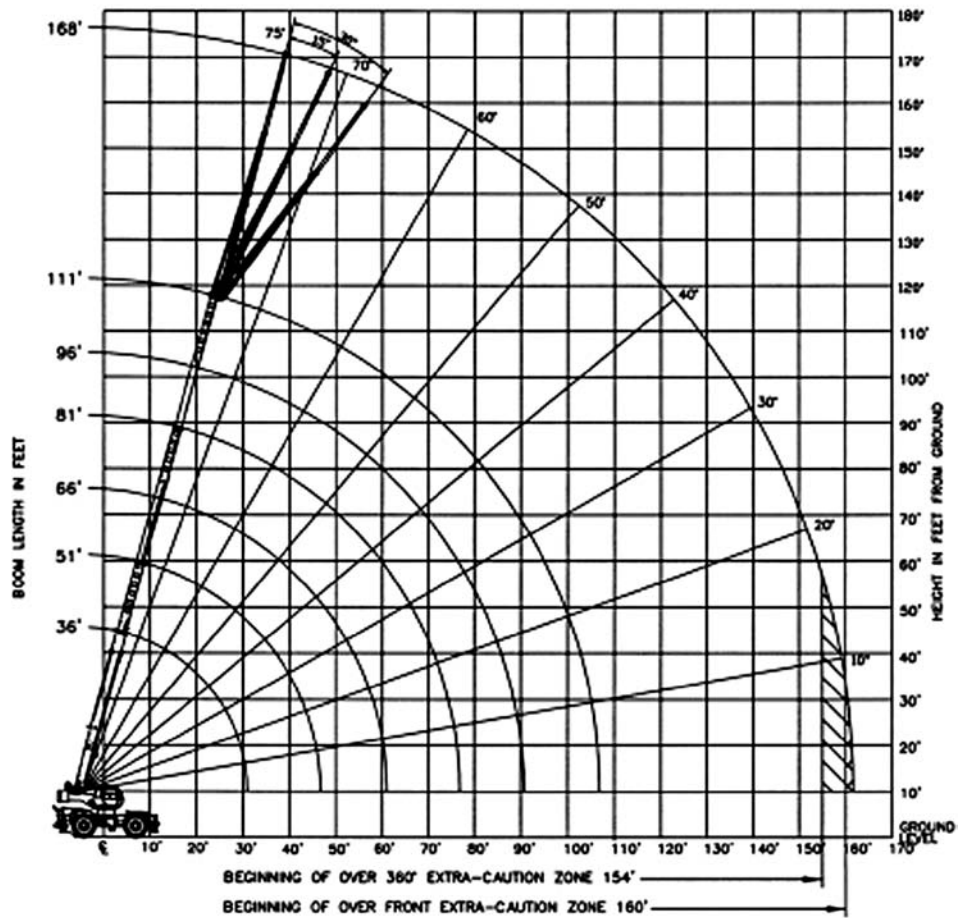

CRANE WORKING CONDITIONS

CRANE WORKING POSITIONS

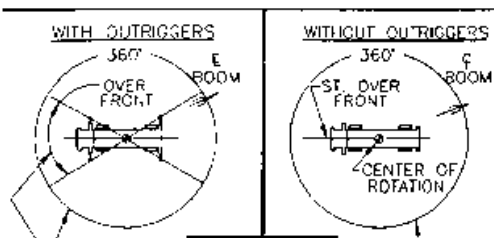

THESE LINES DETERMINE THE LIMITS OF WORKING POSITIONS WHICH CORRESPOND TO THOSE SHOWN ON THE CRANE CAPACITY CHART.

REDUCTION IN MAIN BOOM CAPACITY

All jib in stowed position	0 lb
Aux. boom in head sheave	100 lb

HOOK BLOCK WEIGHTS

Hook and ball	419 lb
Hook block (5 sheave)	1,204 lb

LIFTING CAPACITIES CAUTION: Do not use this specification sheet as a load rating chart. The format of data is not consistent with the machine chart and may be subject to change

ON OUTRIGGERS - FULLY EXTENDED

LOAD RADIUS (FT)	BOOM LENGTH 36'			BOOM LENGTH 51'			BOOM LENGTH 66'			LOAD RADIUS (FT)
	BOOM ANGLE (DEG) REF.	OVER FRONT (LB)	360° (LB)	BOOM ANGLE (DEG) REF.	OVER FRONT (LB)	360° (LB)	BOOM ANGLE (DEG) REF.	OVER FRONT (LB)	360° (LB)	
10	67.1	130,000*	130,000*	74.1	80,100*	80,100*				10
12	63.6	106,800*	106,800*	71.8	80,100*	80,100*				12
15	57.5	86,100*	85,900*	68.1	78,500*	78,500*	73.3	62,000*	62,000*	15
20	48.0	62,100*	62,100*	61.9	63,400*	63,400*	68.7	54,900*	54,900*	20
25	35.9	47,700*	47,700*	55.3	48,900*	48,900*	63.9	49,200*	49,200*	25
30	18.0	37,800*	37,800*	48.0	39,200*	39,200*	58.9	39,900*	39,900*	30
35	**			39.9	32,300*	32,300*	53.7	33,000*	33,000*	35
40				29.9	27,100*	27,000	48.0	27,700	27,500	40
45				15.0	22,200	21,400	41.9	23,000	2,200	45
50				**			34.8	19,100	18,300	50
55							26.2	16,000	15,200	55
60							13.2	13,500	12,700	60
65							**			65
70										70
75										75
80										80
85										85
90										90
95										95
100										100
105										105
110										110

USE THESE CHARTS ONLY WHEN ALL OUTRIGGERS ARE FULLY EXTENDED

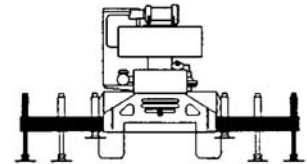



LIFTING CAPACITIES CAUTION: Do not use this specification sheet as a load rating chart. The format of data is not consistent with the machine chart and may be subject to change

ON OUTRIGGERS - FULLY EXTENDED

LOAD RADIUS (FT)	BOOM LENGTH 81'			BOOM LENGTH 96'			BOOM LENGTH 111'			LOAD RADIUS (FT)
	BOOM ANGLE (DEG) REF.	OVER FRONT (LB)	360° (LB)	BOOM ANGLE (DEG) REF.	OVER FRONT (LB)	360° (LB)	BOOM ANGLE (DEG) REF.	OVER FRONT (LB)	360° (LB)	
10										10
12										12
15										15
20	72.8	46,300*	46,300*							20
25	69.0	40,800*	40,800*	72.4	35,400*	35,400*				25
30	65.2	36,100*	36,100*	69.3	31,300*	31,300*	72.2	27,600*	27,600*	30
35	61.2	32,400*	32,400*	66.0	28,100*	28,100*	69.4	24,900*	24,900*	35
40	57.1	28,100*	27,900	62.7	25,400*	25,400*	66.7	22,600*	22,600*	40
45	52.7	23,300	22,500	59.3	23,200*	22,700	63.8	20,700*	20,700*	45
50	48.1	19,400	18,600	55.5	19,600	16,600	60.9	18,900*	18,900*	50
55	43.1	16,400	15,600	52.0	16,600	15,800	57.9	16,700	15,900	55
60	37.6	14,000	13,200	48.1	14,200	13,400	54.7	14,300	13,500	60
65	31.3	12,000	11,300	43.9	12,300	11,500	51.5	12,400	11,600	65
70	23.6	10,300	9,600	39.4	10,600	9,900	48.1	10,800	10,000	70
75	11.9	8,900	8,200	34.4	9,300	8,500	44.5	9,400	8,700	75
80	**			28.7	8,100	7,400	40.7	8,200	7,500	80
85				21.7	7,000	6,300	36.6	7,200	6,500	85
90				11.0	6,000	5,400	31.9	6,300	5,700	90
95				**			26.7	5,500	4,900	95
100							20.1	4,800	4,200	100
105							10.2	4,100	3,600	105
110							**			110

****MAXIMUM CAPACITY AT 0 DEGREE BOOM ANGLE**

BOOM LENGTH 36'			BOOM LENGTH 51'			BOOM LENGTH 66'			BOOM LENGTH 81'			BOOM LENGTH 96'			BOOM LENGTH 111'		
LOAD RADIUS (FT)	OVER FRONT (LB)	360° (LB)	LOAD RADIUS (FT)	OVER FRONT (LB)	360° (LB)	LOAD RADIUS (FT)	OVER FRONT (LB)	360° (LB)	LOAD RADIUS (FT)	OVER FRONT (LB)	360° (LB)	LOAD RADIUS (FT)	OVER FRONT (LB)	360° (LB)	LOAD RADIUS (FT)	OVER FRONT (LB)	360° (LB)
31.7	20,400*	20,400*	46.7	12,400*	12,400*	61.7	8,000*	8,000*	76.7	5,300*	5,300*	91.7	3,400*	3,400*	106.7	2,100*	2,100*

LIFTING CAPACITIES CAUTION: Do not use this specification sheet as a load rating chart. The format of data is not consistent with the machine chart and may be subject to change

ON OUTRIGGERS - MID POSITION

LOAD RADIUS (FT)	BOOM LENGTH 36'		BOOM LENGTH 51'		BOOM LENGTH 66'		BOOM LENGTH 81'		BOOM LENGTH 96'		BOOM LENGTH 111'		LOAD RADIUS (FT)
	BOOM ANGLE (DEG) REF.	360° (LB)	BOOM ANGLE (DEG) REF.	360° (LB)	BOOM ANGLE (DEG) REF.	360° (LB)	BOOM ANGLE (DEG) REF.	360° (LB)	BOOM ANGLE (DEG) REF.	360° (LB)	BOOM ANGLE (DEG) REF.	360° (LB)	
10	67.1	121,200*	74.1	80,100*									10
12	63.6	106,800*	71.8	80,100*									12
15	57.5	86,000*	68.1	78,500*	73.3	62,000*							15
20	48.0	48,800	61.9	49,900	68.7	50,400	72.8	46,300*					20
25	35.9	31,300	55.3	32,700	63.9	33,200	69.0	33,500	72.4	33,700			25
30	18.0	21,800	48.0	23,400	58.9	23,900	65.2	24,200	69.3	24,400	72.2	24,500	30
35	**		39.9	17,500	53.7	18,100	61.2	18,300	66.0	18,500	69.4	18,600	35
40			29.9	13,300	48.0	14,100	57.1	14,300	62.7	14,500	66.7	14,600	40
45			15.0	10,300	41.9	11,100	52.7	11,400	59.3	11,600	63.8	11,700	45
50			**		34.8	8,800	48.1	9,200	55.5	9,400	60.9	9,500	50
55					26.2	7,000	43.1	7,400	52.0	7,600	57.9	7,800	55
60					13.2	5,400	37.6	5,900	48.1	6,200	54.7	6,300	60
65					**		31.3	4,700	43.9	5,000	51.5	5,200	65
70							23.6	3,700	39.4	4,000	48.1	4,200	70
75							11.9	2,800	34.4	3,100	44.5	3,300	75
80							**		28.7	2,400	40.7	2,600	80

****MAXIMUM CAPACITY AT 0 DEGREE BOOM ANGLE**

BOOM LENGTH 36'		BOOM LENGTH 51'		BOOM LENGTH 66'		BOOM LENGTH 81'		BOOM LENGTH 96'		BOOM LENGTH 111'	
LOAD RADIUS (FT)	360° (LB)	LOAD RADIUS (FT)	360° (LB)	LOAD RADIUS (FT)	360° (LB)	LOAD RADIUS (FT)	360° (LB)	LOAD RADIUS (FT)	360° (LB)	LOAD RADIUS (FT)	360° (LB)
31.7	19,200	46.7	9,300	61.7	4,900	76.7	2,500				

USE THESE CHARTS ONLY WHEN ALL OUTRIGGERS ARE PINNED IN MID POSITION

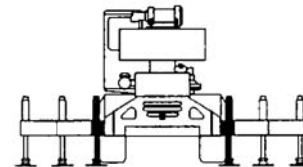

LIFTING CAPACITIES CAUTION: Do not use this specification sheet as a load rating chart. The format of data is not consistent with the machine chart and may be subject to change

ON OUTRIGGERS - RETRACTED

LOAD RADIUS (FT)	BOOM LENGTH 36'		BOOM LENGTH 51'		BOOM LENGTH 66'		BOOM LENGTH 81'		BOOM LENGTH 96'		BOOM LENGTH 111'		LOAD RADIUS (FT)
	BOOM ANGLE (DEG) REF.	360° (LB)	BOOM ANGLE (DEG) REF.	360° (LB)	BOOM ANGLE (DEG) REF.	360° (LB)	BOOM ANGLE (DEG) REF.	360° (LB)	BOOM ANGLE (DEG) REF.	360° (LB)	BOOM ANGLE (DEG) REF.	360° (LB)	
10	67.1	73,700	74.1	74,900									10
12	63.6	51,700	71.8	51,700									12
15	57.5	34,300	68.1	35,300	73.3	35,800							15
20	48.0	20,100	61.9	21,400	68.7	21,800	72.8	22,100					20
25	35.9	12,800	55.3	14,100	63.9	14,600	69.0	14,900	72.4	15,000			25
30	18.0	8,200	48.0	9,600	58.9	10,200	65.2	10,500	69.3	10,700	72.2	10,800	30
35	**		39.9	6,600	53.7	7,200	61.2	7,600	66.0	7,700	69.4	7,800	35
40			29.9	4,400	48.0	5,000	57.1	5,400	62.7	5,600	68.7	5,700	40
45			15.0	2,600	41.9	3,400	52.7	3,800	59.3	4,000	63.8	4,100	45
50							48.1	2,500	55.5	2,700	60.9	2,900	50
55													55

****MAXIMUM CAPACITY AT 0 DEGREE BOOM ANGLE**

BOOM LENGTH 36'		BOOM LENGTH 51'		BOOM LENGTH 66'		BOOM LENGTH 81'		BOOM LENGTH 96'		BOOM LENGTH 111'	
LOAD RADIUS (FT)	360° (LB)	LOAD RADIUS (FT)	360° (LB)	LOAD RADIUS (FT)	360° (LB)	LOAD RADIUS (FT)	360° (LB)	LOAD RADIUS (FT)	360° (LB)	LOAD RADIUS (FT)	360° (LB)
31.7	6,800										

USE THESE CHARTS WHEN ALL OUTRIGGER BEAMS ARE NOT IN EITHER THE MID OR FULLY EXTENDED POSITION

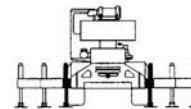



LIFTING CAPACITIES CAUTION: Do not use this specification sheet as a load rating chart. The format of data is not consistent with the machine chart and may be subject to change.

SIDE STOW JIB ON FULLY EXTENDED OUTRIGGERS

LOADED BOOM ANGLE (DEG)	32' OFFSETTABLE JIB/NO PULL OUT INSTALLED									49' OFFSETTABLE JIB/PULL OUT RETRACTED									LOADED BOOM ANGLE (DEG)
	0° OFFSET			15° OFFSET			30° OFFSET			0° OFFSET			15° OFFSET			30° OFFSET			
	LOAD RADIUS (REF) (FT)	FRONT ONLY (LB)	360° (LB)	LOAD RADIUS (REF) (FT)	FRONT ONLY (LB)	360° (LB)	LOAD RADIUS (REF) (FT)	FRONT ONLY (LB)	360° (LB)	LOAD RADIUS (REF) (FT)	FRONT ONLY (LB)	360° (LB)	LOAD RADIUS (REF) (FT)	FRONT ONLY (LB)	360° (LB)	LOAD RADIUS (REF) (FT)	FRONT ONLY (LB)	360° (LB)	
75	40	12,600*	12,600*	48	8,500*	8,500*	54	6,600*	6,600*	41	12,600*	12,600*	49	8,500*	8,500*	55	6,600*	6,600*	75
73	46	11,900*	11,900*	53	8,200*	8,200*	59	6,400*	6,400*	47	11,900*	11,900*	54	8,200*	8,200*	60	6,400*	6,400*	73
71	51	11,300*	11,300*	58	7,800*	7,800*	63	6,300*	6,300*	52	11,300*	11,300*	59	7,800*	7,800*	64	6,300*	6,300*	71
68	58	10,400*	10,400*	65	7,400*	7,400*	70	6,000*	6,000*	59	10,400*	10,400*	66	7,400*	7,400*	71	6,000*	6,000*	68
65	65	9,600*	9,600*	71	7,100*	7,100*	76	5,900*	5,900*	66	9,600*	9,600*	72	7,100*	7,100*	77	5,900*	5,900*	65
62	71	8,900*	8,900*	78	6,800*	6,800*	83	5,700*	5,700*	72	8,900*	8,900*	79	6,800*	6,800*	84	5,700*	5,700*	62
59	78	8,300*	8,300*	84	6,500*	6,500*	88	5,500*	5,500*	79	8,300*	8,200*	85	6,500*	6,500*	89	5,500*	5,500*	59
55	86	7,700*	7,700*	91	6,200*	6,200*	95	5,300*	5,300*	87	7,600*	6,800	92	6,200*	6,200*	96	5,300*	5,300*	55
51	93	7,100*	6,500	98	5,900*	5,900*	102	5,200*	5,200*	94	6,300	5,700	99	5,600	5,200	103	5,200*	5,000*	51
47	100	6,000	5,500	105	5,500	5,100	108	5,000*	5,000*	101	5,300	4,700	106	4,800	4,400	109	4,700	4,200	47
43	106	5,200	4,600	111	4,800	4,400	113	4,700	4,300	107	4,400	3,900	112	4,100	3,600	114	4,000	3,600	43
38	113	4,300	3,800	119	4,100	3,600	119	4,000	3,600	114	3,600	3,100	120	3,400	2,900	120	3,300	2,900	38
32	121	3,500	3,100	124	3,400	2,900	125	3,300	2,900	122	2,800	2,300	125	2,700	2,200	126	2,600	2,200	32
25	127	2,900	2,500	130	2,800	2,300				129	2,200	1,800	132	2,100	1,700				25
17	133	2,400	2,000	135	2,300	1,900				135	1,700	1,300	137	1,700	1,300				17



LIFTING CAPACITIES

CAUTION: Do not use this specification sheet as a load rating chart. The format of data is not consistent with the machine chart and may be subject to change

SIDE STOW JIB ON FULLY EXTENDED OUTRIGGERS

Notes For Jib Capacities:

LOADED BOOM ANGLE (DEG)	57' OFFSETTABLE JIB									LOADED BOOM ANGLE (DEG)
	0° OFFSET			15° OFFSET			30° OFFSET			
	LOAD RADIUS (REF) (FT)	FRONT ONLY (LB)	360° (LB)	LOAD RADIUS (REF) (FT)	FRONT ONLY (LB)	360° (LB)	LOAD RADIUS (REF) (FT)	FRONT ONLY (LB)	360° (LB)	
75	52	6,600*	6,600*	64	4,600*	4,600*	74	3,400*	3,400*	75
73	58	6,200*	6,200*	70	4,400*	4,400*	80	3,300*	3,300*	73
71	64	5,900*	5,900*	76	4,200*	4,200*	85	3,200*	3,200*	71
68	73	5,600*	5,600*	83	3,900*	3,900*	92	3,100*	3,100*	68
65	81	5,200*	5,200*	91	3,700*	3,700*	99	3,000*	3,000*	65
62	89	4,800*	4,800*	98	3,500*	3,500*	106	2,900*	2,900*	62
59	96	4,500*	4,500*	105	3,400*	3,400*	112	2,800*	2,800*	59
55	105	4,100*	4,100*	113	3,200*	3,200*	119	2,700*	2,700*	55
51	114	3,800*	3,800*	121	3,000*	3,000*	126	2,700*	2,700*	51
47	122	3,500*	3,500*	128	2,900*	2,900*	132	2,600*	2,600*	47
43	129	3,300*	3,000	135	2,800*	2,800*	138	2,600*	2,600*	43
38	137	2,700	2,400	142	2,600	2,200	144	2,500	2,200	38
32	145	2,200	1,800	149	2,100	1,700	149	2,000	1,700	32
25	153	1,600	1,300	155	1,600	1,200				25
17	159	1,200	1,000	160	1,200	900				17

- A. For all boom lengths less than the maximum with a jib erected, the rated loads are determined by boom angle only in the appropriate column.
- B. For boom angle not shown, use the capacity of the next lower boom angle.
- C. Listed radii are for extended main boom only.

ON TIRES

RADIUS (FT)	MAX BOOM LENGTH (FT)	29.5 X 25 28 PR			
		STATIONARY		PICK & CARRY	
		STATIC		CREEP	2.5 MPH
		360°	STRAIGHT OVER FRONT		
10	36	55,700	87,600*	68,800	51,900
12	36	42,800	77,300*	60,500	45,400
15	36	29,500	61,400	50,800	37,700
20	36	17,600	37,300	37,300	28,800
25	51	11,800	22,600	22,600	22,600
30	51	8,000	15,700	15,700	15,700
35	51	5,700	12,700	12,700	12,700
40	51	4,100	10,200	10,200	10,200
45	66	2,900	8,100	8,100	8,100
50	66	1,900	6,500	6,500	6,500
55	66		5,200	5,200	5,200
60	81		4,200	4,200	4,200
65	81		3,400	3,400	3,400
75	81		2,700	2,700	2,700

Notes For On Tire Capacities:

- A. For Pick and Carry operations, boom must be centered over the front of the crane with swing brake and lock engaged. Use minimum boom point height and keep load close to ground surface.
- B. The load should be restrained from swinging. NO ON TIRE OPERATION WITH JIB ERECTED.
- C. Without outriggers, never maneuver the boom beyond listed load radii for applicable tires to ensure stability.
- D. Creep speed is crane movement of less than 200' (61 m) in a 30 minute period and not exceeding 1.0 mph (1.6 km/h).
- E. Refer to General Notes for additional information.

RECOMMENDED TIRE PRESSURE

TIRE SIZE	STATIONARY	CREEP	2 1/2 MPH	TRAVEL
29.5 x 25-28 PR	81 PSI	81 PSI	65 PSI	55 PSI

MAXIMUM PERMISSIBLE HOIST LINE LOAD

LINE PARTS	1	2	3	4	5	6	7	8	9	10
MAIN & AUX. HOIST	13,800	27,600	41,400	55,200	69,000	82,800	96,600	100,400	124,200	130,000
WIRE ROPE:	3/4" ROTATION RESISTANT 34X7 COMPACTED STRAND, GRADE 2160, MINIMUM BREAKING STRENGTH - 34.5 TONS. 3/4" 6X19 OR 6X37, IPS, IWRC, PERFORMED RIGHT REGULAR LAY MINIMUM BREAKING STRENGTH - 25.6 TONS. WEIGHT 1.04 LB/FT.									



General Notes | RT600 Series

GENERAL

1. Rated loads as shown on Lift Charts pertain to this machine as originally manufactured and equipped. Modifications to the machine or use of optional equipment or other than that specified can result in a reduction of capacity.
2. Construction equipment can be hazardous if improperly operated or maintained. Operation and maintenance of this machine shall be in compliance with the information in the Operator's, Parts and Safety Manuals supplied with this machine. If These manuals are missing, order replacements from the manufacturer through your distributor.
3. These warnings do not constitute all of the operating conditions for the crane. The operator and job site supervision must read the OPERATORS MANUAL, CIMA SAFETY MANUAL, APPLICABLE OSHA REGULATIONS, AND SOCIETY OF MECHANICAL ENGINEERS (ASME) SAFETY STANDINGS FOR CRANES.
4. This crane and its load ratings are in accordance with POWER CRANE & SHOVEL ASSOCIATION, STANDARD NO.4 SAE CRANE LOAD STABILITY TEST CODE J765A, SAE METHOD OF TEST FOR CRANE STRUCTURE J1063 AND APPLICABLE SAFETY CODE FOR CRANES, DERRICKS AND HOISTS, ASME/ANSI B30.5

DEFINITIONS

1. **LOAD RADIUS** - The horizontal distance from the axis of rotation before loading to the center of the vertical hoist line or tackle with a load applied.
2. **LOADED BOOM ANGLE** - It is the angle between the boom base section and the horizontal, after lifting the rated load at the rated radius. The boom angle before loading should be greater to account for deflections. The loaded boom angle combined with boom length give only an approximation of the operating radius.
3. **WORKING AREA** - Areas measured in a circular arc about the centerline of rotation as shown in the diagram.
4. **FREELY SUSPENDED LOAD** - Load hanging free with no direct external force applied except by the hoist rope.
5. **SIDE LOAD** - Horizontal force applied to the lifted load either on the ground or in the air.
6. **NO LOAD STABILITY LIMIT** - The stability limit radius shown on the range diagrams is the radius beyond which it is not permitted to position the boom, when the boom angle is less than the minimum shown on the applicable load chart, because the machine can overturn without any load.
7. **BOOM SIDE OF CRANE** - The side of the crane over which the boom is positioned when in OVER SIDE working position.

SET-UP

1. Crane load ratings are based on the crane being leveled and standing on a firm, uniform supporting surface.
2. Crane load ratings on outriggers are based on all outrigger beams being fully extended or in the case of partial extension ratings mechanically pinned in the appropriate position, and the tires free of the supporting surface.
3. Crane load ratings on tires depend on appropriate inflation pressure and the tire conditions. Caution must be exercised when increasing air pressures in tires. Consult Operator's Manual for precautions.
4. Use of jibs, lattice-type boom extensions, or fourth section pullouts extended is not permitted for pick and carry operations.
5. Consult appropriate section of the Operator's and Service Manual for more exact description of hoist line reeving.
6. The use of more parts of line than required by the load may result in having insufficient rope to allow the hook block to reach the ground.
7. Properly maintained wire rope is essential for safe crane operation. Consult Operator's Manual for proper maintenance and inspection requirements.
8. When spin-resistant wire rope is used, the allowable rope loading shall be the breaking strength divided by five (5), unless otherwise specified by the wire rope manufacturer.
9. Do not elevate the boom above 60° unless the boom is positioned in-line with the crane's chassis or the outrigger are extended. Failure to observe this warning may result in loss of stability.

OPERATION

1. **CRANE LOAD RATINGS MUST NOT BE EXCEEDED. DO NOT ATTEMPT TO TIP THE CRANE TO DETERMINE ALLOWABLE LOADS.**
2. When either radius or boom length, or both, are between listed values, the smaller of the two listed load ratings shall be used.
3. Do not operate at longer radii than those listed on the applicable load rating chart (cross hatched areas shown on range diagrams.)
4. The boom angles shown on the Capacity Chart give an approximation of the operating radius for a specified boom length. The boom angle, before loading, should be greater to account for boom deflection. It may be necessary to retract the boom if maximum boom angle is insufficient to maintain rated radius.
5. Power telescoping boom sections must be extended equally.
6. Rated loads include the weight of hook block, slings, and auxiliary lifting devices. Their weights shall be subtracted from the listed rated load to obtain the net load that can be lifted. When lifting over the jib the weight of any hook block, slings, and auxiliary lifting devices at the boom head must be added to the load. When jibs are erected but unused add two (2) times the weight of any hook block, slings, and auxiliary lifting devices at the jib head to the load.
7. Rated loads do not exceed 85% on outriggers or 75% on tires, of the tipping load as determined by SAE Crane Stability Test Code J765a. Structural strength ratings in chart are indicated with an asterisk (*).
8. Rated loads are based on freely suspended loads. No attempt shall be made to drag a load horizontally on the ground in any direction.
9. The user shall operate at reduced ratings to allow for adverse job conditions, such as: soft or uneven ground, out of level conditions, high winds, side loads, pendulum action, jerking or sudden stopping of loads, hazardous conditions, experience of personnel, two machine lifts, traveling with loads, electric wires, etc. (side pull on boom or jib is hazardous). Derating of the cranes lifting capacity is required when wind speed exceeds 20 MPH. The center of the lifted load must never be allowed to move more than 3' off the center line of the base boom section due to the effects of wind, inertia, or any combination of the two.
Use 2' off the center line of the base boom for a two section boom, 3' for a three section boom, or 4' for a four section boom.
10. The maximum load which can be telescoped is not definable, because of variations in loadings and crane maintenance, but it is permissible to attempt retraction and extension if load ratings are not exceeded.
11. Load ratings are dependent upon the crane being maintained according to manufacturer's specifications.
12. It is recommended that load handling devices, including hooks, and hook blocks, be kept away from boom head at all times.
13. **FOR TRUCK CRANES ONLY:** 360° capacities apply only to machines equipped with a front outrigger jack and all five(5) outrigger jacks properly set. If the front (5th) outrigger jack is not properly set, the work area is restricted to the over side and over rear areas as shown on the Crane Working Positions diagram. Use the 360° load ratings in the overside work areas.
14. Do not lift with outrigger beams positioned between the fully extended and intermediate (pinned) positions.
15. Truck Cranes not equipped with equalizing (bogie) beams between the rear axles may not be used for lifting "on tires". Truck Cranes equipped with equalizing beams and rear air suspension should "dump" the air before lifting "on tires".

CLAMSHELL, MAGNET, AND CONCRETE BUCKET SERVICE

1. Maximum boom length for clamshell and magnet service is 50'.
2. Weight of clamshell or magnet, plus contents are not to exceed 6,000 lb or 90% of rated lifting capacities, whichever is less. For concrete bucket operation, weight of bucket and load must not exceed 90% of rated lifting capacity.

TEREX Cranes
106-12th Street S.E.
Waverly, Iowa 50677-9466 USA

TEL (319) 352-3920 FAX (319) 352-5727
EMAIL inquire@terexwaverly.com
WEB terex.com

WE RESERVE THE RIGHT TO AMEND THESE SPECIFICATIONS AT ANY TIME WITHOUT NOTICE. THE ONLY WARRANTY APPLICABLE IS OUR STANDARD WRITTEN WARRANTY APPLICABLE TO THE PARTICULAR PRODUCT AND SALE. WE MAKE NO OTHER WARRANTY, EXPRESSED OR IMPLIED.