



# GR-1000XL

100 Ton Capacity (90.7 Metric Tons)

## HYDRAULIC ROUGH TERRAIN CRANE

### DIMENSIONS

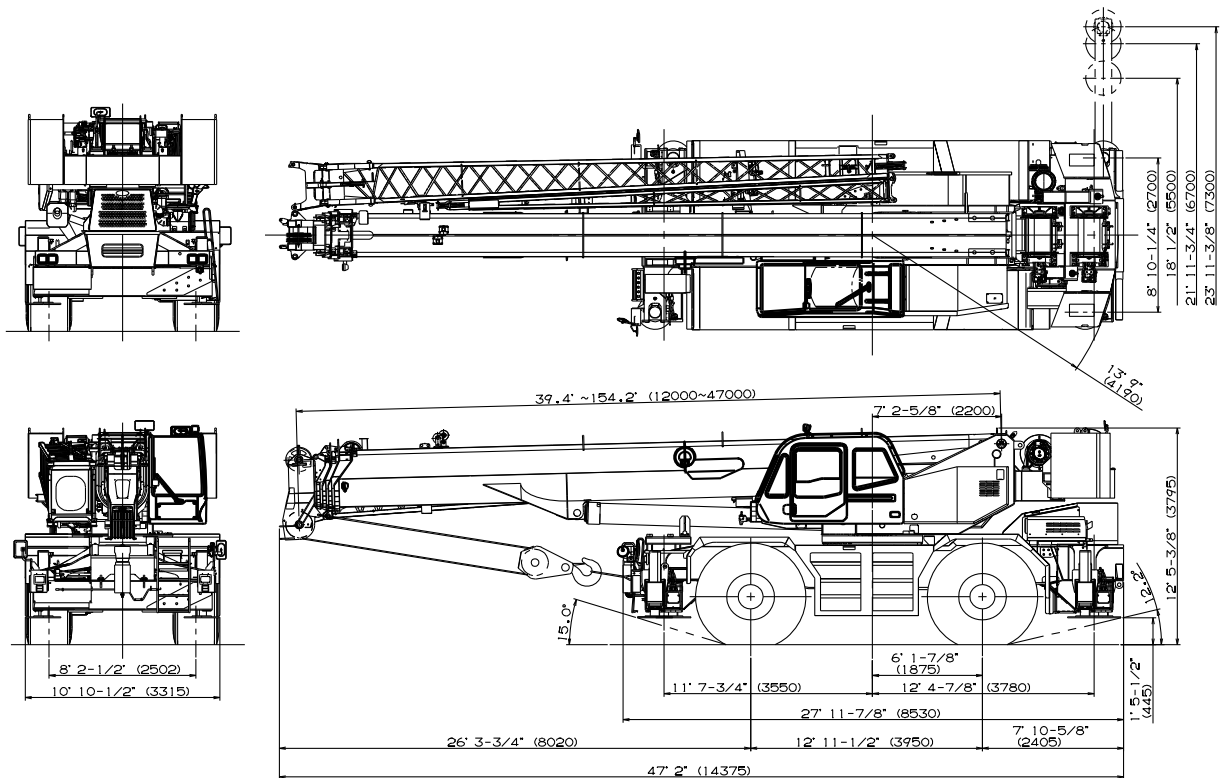

Note : Dimension is with boom angle at -1.5 degree.

### GENERAL DIMENSIONS (29.5 - 25 Tires)

	Feet	Meters
Turning radius		
4 wheel steer	22' 4"	6.8
2 wheel steer	39' 1"	11.9
Tail swing of counterweight	13' 9"	4.19

Specifications are subject to change without notice.  
Specification effective with serial number 548764 and up.

# CRANE SPECIFICATIONS

## BOOM

Five section full power synchronized telescoping boom, 39.4'~154.2' (12.0m~47.0m), of round box construction with seven sheaves, 17-5/16" (0.44m) root diameter, at boom head. The synchronization system consists of two telescope cylinders, an extension cable and retraction cable. Hydraulic cylinder fitted with holding valve. Two easily removable wire rope guards, rope dead end provided on both sides of boom head. Boom telescope sections are supported by wear pads both vertically and horizontally. Extension speed 114.8' in 160 seconds.

**BOOM ELEVATION** - By a double acting hydraulic cylinder with holding valve. Elevation  $-1.5^{\circ}$ ~ $80.5^{\circ}$ , combination controls for hand or foot operation. Boom angle indicator. Automatic speed reduction and soft stop function. Boom raising speed  $20^{\circ}$  to  $60^{\circ}$  in 46 sec.

**JIB** - Two stage bi-fold lattice type with  $3.5^{\circ}$ ,  $25^{\circ}$  or  $45^{\circ}$  offset (tilt type). Single sheave, 15-5/8" (0.396m) root diameter, at the head of both jib sections. Stored alongside base boom section. Jib length is 33.2' (10.1m) or 58.1' (17.7m). Assistant cylinders for mounting and stowing, controlled at right side of superstructure. Self stowing jib mounting pins.

## AUXILIARY LIFTING SHEAVE (SINGLE TOP)

Single sheave, 15-5/8" (0.396m) root diameter. Mounted to main boom head for single line work (storable).

**ANTI-TWO BLOCK** - Pendant type over-winding cut out device with audio-visual (FAILURE lamp/BUZZER) warning system.

## SLEWING

Hydraulic axial piston motor through planetary slewing speed reducer. Continuous  $360^{\circ}$  full circle slewing on ball bearing turn table at  $1.5\text{min}^{-1}$  {rpm}. Equipped with manually locked/released slewing brake. A  $360^{\circ}$  positive slewing lock for pick and carry and travel modes, manually engaged in cab. Twin slewing system: Free slewing or lock slewing controlled by selector switch on front console.

## HOIST

**MAIN HOIST** - Variable speed type with grooved drum driven by hydraulic axial piston motor through speed reducer. Power load lowering and raising. Equipped with automatic brake (neutral brake) and counterbalance valve. Controlled independently of auxiliary hoist. Equipped with cable follower and drum rotation indicator.

**DRUM** - Grooved 14-1/4" (0.362m) root diameter x 23-5/8" (0.6m) wide. Wire rope: 830' of 3/4" diameter rope (253m of 19mm). Drum capacity: 997' (304m) 7 layers. Maximum single line pull (available): 20,000 lbs (9,090kg). Maximum line speed: 560FPM (170m/min) at the 6th layer.

**AUXILIARY HOIST** - Variable speed type with grooved drum driven by hydraulic axial piston motor through speed reducer. Power load lowering and raising. Equipped with automatic brake (neutral brake) and counterbalance valve. Controlled independently of main hoist. Equipped with cable follower and drum rotation indicator.

**DRUM** - Grooved 14-1/4" (0.362m) root diameter x 23-5/8" (0.6m) wide. Wire rope: 456' of 3/4" diameter rope (139m of 19mm). Drum capacity: 997' (304m) 7 layers. Maximum single line pull (available): 20,000 lbs (9,090kg). Maximum line speed: 491FPM (149m/min) at the 4th layer.

**WIRE ROPE** - Non-rotating 3/4" (19mm) 7x35 class. Breaking strength (Main and Aux): 72,800 lbs (33,000 kg)

## HOOK BLOCKS

100 ton (90.7 metric ton) - 8 sheaves with swivel hook block and safety latch.  
7.3 ton (6.6 metric ton) - Weighted hook ball with swivel and safety latch.

## HYDRAULIC SYSTEM

**PUMPS** - Two variable piston pumps for crane functions. Tandem gear pump for steering, slewing and optional equipment. Powered by carrier engine. Pump disconnect for crane is engaged/disengaged by rotary switch from operator's cab.

**CONTROL VALVES** - Multiple valves actuated by pilot pressure with integral pressure relief valves.

**RESERVOIR** - 202 gallon (763 lit.) capacity. External sight level gauge.

**FILTRATION** - BETA10=10 return filter, full flow with bypass protection, located inside of hydraulic reservoir. Accessible for easy replacement.

**OIL COOLER** - Air cooled fan type.

## CAB AND CONTROLS

Both crane and drive operations can be performed from one cab mounted on rotating superstructure.

Left side, 1 man type, steel construction with sliding door access and safety glass windows opening at side. Door window is powered control. Windshield glass window and roof glass window are shatter-resistant. Tilt-telescoping steering wheel. Adjustable control lever stands for slewing, boom elevating, boom telescoping, auxiliary hoist and main hoist. Control lever stands can change neutral positions and tilt for easy access to cab. 3 way adjustable operator's seat with high back, headrest and armrest. Engine throttle knob. Foot operated controls: boom elevating, boom telescoping, service brake and engine throttle. Hot water cab heater and air conditioning.

Dash-mounted engine start/stop, monitor lamps, cigarette lighter, drive selector switch, parking brake switch, steering mode select switch, power window switch, pump engaged/disengaged switch, slewing brake switch, telescoping/auxiliary hoist select switch, outrigger controls, free slewing / lock slewing selector switch, eco mode switch, high speed hoist (main/aux) switch and ashtray.

Instruments - Torque converter oil temperature, engine water temperature, air pressure, fuel, speedometer, tachometer, hour meter and odometer / tripmeter. Hydraulic oil pressure is monitored and displayed on the AML-C display panel.

Tadano electronic LOAD MOMENT INDICATOR system (AML-C) including:

- Control lever lockout function
- Boom position indicator
- Outrigger state indicator
- Boom angle / boom length / jib offset angle / jib length / load radius / rated lifting capacities / actual loads read out
- Ratio of actual load moment to rated load moment indication
- Automatic Speed Reduction and Slow Stop function on boom elevation and slewing
- Working condition register switch
- Load radius / boom angle / tip height / slewing range preset function
- External warning lamp
- Tare function
- Fuel consumption monitor
- Main hoist / auxiliary hoist select
- Drum rotation indicator (audible and visible type) main and auxiliary hoist

TADANO AML-C monitors outrigger extended length and automatically programs the corresponding "RATED LIFTING CAPACITIES" table

Operator's right hand console includes transmission gear selector, and slewing lock lever and sight level bubble. Upper console includes working light switch, roof washer and wiper switch, emergency outrigger set up key switch, jib equipped/removed select switch, eco mode switch, high speed hoist (main/aux) switch and air conditioning control switch.

NOTE: Each crane motion speed is based on unloaded conditions.

## CARRIER SPECIFICATIONS

**TYPE** - Rear engine, left hand steering, driving axle 2-way selected type by manual switch, 4x2 front drive, 4x4 front and rear drive.

**FRAME** - High tensile steel, all welded mono-box construction.

**TRANSMISSION** - Electronically controlled full automatic transmission. Torque converter driving full powershift with driving axle selector. 6 forward and 2 reverse speeds, constant mesh.

- 3 speeds - high range - 2 wheel drive; 4 wheel drive
- 3 speeds - low range - 4 wheel drive

**TRAVEL SPEED** - 22 mph (36 km/h)

**GRADEABILITY (tanθ)** - 94% (at stall), \*\*57%

\*\* Machine should be operated within the limit of engine design. (30°: Cummins QSB6.7)

**AXLE** - Front: Full floating type, steering and driving axle with planetary reduction. Rear: Full floating type, steering and driving axle with planetary reduction and non-spin rear differential.

**STEERING** - Hydraulic power steering controlled by steering wheel. Four steering modes available: 2 wheel front, 2 wheel rear, 4 wheel coordinated and 4 wheel crab .

**SUSPENSION** - Front: Rigid mounted to frame. Rear: Pivot mounted with hydraulic lockout device.

**BRAKE SYSTEMS** - Service: Air over hydraulic disc brakes on all 4 wheels. Parking/Emergency: Spring applied-air released brake acting on input shaft of front axle. Auxiliary: Electro-pneumatic operated exhaust brake.

**TIRES** - 29.5-25 34PR(OR)

**OUTRIGGERS** - Four hydraulic, beam and jack outriggers. Vertical jack cylinders equipped with integral holding valve. Each outrigger beam and jack is controlled independently from cab. Beams extend to 23' 11-3/8" (7.3 m) center-line and retract to within 10' 10-1/2" (3.315 m) overall width with floats. Outrigger jack floats are attached thus eliminating the need of manually attaching and detaching them. Controls and sight bubble located in superstructure cab. Four outrigger extension lengths are provided with corresponding "RATED LIFTING CAPACITIES" for crane duty in confined areas.

Min. Extension	8' 10-1/4" (2.7m) center to center
Mid. Extension	18' 1/2" (5.5m) center to center
Mid. Extension	21' 11-3/4" (6.7m) center to center
Max. Extension	23' 11-3/8" (7.3m) center to center
Float size(Diameter)	1' 11- 5/8" (0.6m)

### ENGINE

Model	Cummins QSB6.7 [Tier 4]
Type	Direct injection diesel
No. of cylinders	6
Combustion	4 cycle, turbo charged and after cooled
BoreXStroke, in.(mm)	4.212 x 4.882 (107 x 124)
Displacement, cu. in (liters)	409 (6.700)
Air inlet heater	24 volt preheat
Air cleaner	Dry type, replaceable element
Oil filter	Full flow with replaceable element
Fuel filter	Full flow with replaceable element
Fuel tank, gal.(liters)	79.2 (300), right side of carrier
Cooling	Liquid pressurized, recirculating by-pass

Radiator	Fin and tube core, thermostat controlled
Fan, in.(mm)	Suction type, 9-blade, 28 (711) dia.
Starting	24 volt
Charging	24 volt system, negative ground
Battery	2-120 amp. Hour
Compressor, air, CFM(l /min)	17.0 CFM (481) at 2,400rpm
Horsepower (kW)	Gross 270 (201) at 2,000rpm
Torque, Max. ft-lb (Nm)	730 (990) at 1,500rpm
Capacity, gal.(liters)	
Cooling water	7.4 (28)
Lubrication	4.0 (15)
Fuel	79.2 (300)
DEF	10.0 (38)

# STANDARD EQUIPMENT

- Five section full power partially synchronized boom 39.4'~154.2' (12.0 m~47.0 m)
- 33.2' or 58.1' (10.1 m or 17.7 m) bi-fold lattice jib (tilt type) with 3.5°, 25° or 45° pinned offsets and self storing pins.
- Auxiliary lifting sheave (single top) storable
- Variable speed main hoist with grooved drum, cable follower and 830' of 3/4" cable.
- Variable speed auxiliary hoist with grooved drum, cable follower and 456' of 3/4" cable.
- Drum rotation indicator (audible, visible and thumper type) main and auxiliary hoist
- 2-speed hoist
- Anti-Two block device (overwind cutout)
- Boom angle indicator
- Tadano electronic load moment indicator system (AML-C)
- Outrigger extension length detector
- Electronic crane monitoring system
- Tadano twin slewing system and 360° positive slewing lock
- Self centering finger control levers with pilot control
- Control pedals for boom elevating and boom telescoping
- 3 way adjustable cloth seat with armrests, high back and seat belt
- Tilt-telescoping steering wheel
- Tinted safety glass and sun visor
- Front windshield wiper and washer
- Roof window wiper and washer
- Power window (cab door)
- Rear view mirrors (right and left side)
- Mirror for main and auxiliary hoists
- Cigarette lighter and ashtray
- Cab floor mat
- Pump disconnect in operator's cab
- Hydraulic oil cooler
- Hot water cab heater and air conditioner
- Positive control
- Quick reeving type bi-fold jib
- Work lights
- Independently controlled outriggers
- Four outrigger extension positions
- Self-storing outrigger pads
- Cummins QSB6.7 turbo charged after cooled engine (270HP) with exhaust brake
- Electronic controlled automatic transmission driven by torque converter
- 4 X 4 X 4 drive/steer
- Non-spin rear differential
- Automatic rear axle oscillation lockout system
- 29.5-25 34PR tires
- Disc brakes
- Fenders
- Air dryer
- Water separator with filter(high filtration)
- Engine over-run alarm
- Back-up alarm
- Low oil pressure/high water temp. warning device (visual)
- Rear steer centering light
- Air cleaner dust indicator
- Full instrumentation package
- Complete highway light package
- Tool storage compartment
- Tire inflation kit
- 24 volt electric system
- 7.3 ton (6.6 metric ton) hook ball with swivel
- 100 ton (90.7 metric ton) - 8 sheaves with swivel hook block and safety latch for 3/4"(19mm) wire rope
- Towing hooks-Front and rear
- Lifting eyes
- Hook block tie down (front bumper)
- Weighted hook storage compartment
- Halogen head lamp
- Telematics (machine data logging and monitoring system) with HELLO-NET via internet
- Fuel consumption monitor
- Eco mode system
- Self-removable counterweight

# HOISTING PERFORMANCE

## LINE SPEEDS AND PULLS

Layer	Main or auxiliary hoist - 14'-1/4" (0.362m) drum							
	Line speeds <sup>1</sup>				Line pulls - Available <sup>2</sup>			
	Low		High		Low		High	
	F.P.M.	m/min	F.P.M.	m/min	Lbs.	kgf	Lbs.	kgf
1st	278	84	387	118	20,000	9,090	14,400	6,520
2nd	302	92	421	128	18,100	8,230	13,000	5,900
3rd	327	99	456	139	16,600	7,520	11,900	5,390
4th	352	107	491	149	15,300	6,920	10,900	4,960
5th	377	115	526	160	14,100	6,410	10,100	4,600
6th	402	122	560	170	13,200	5,970	9,400	4,280
7th <sup>3</sup>	427	130	595	181	12,300	5,590	8,800	4,010

\* Maximum permissible line pull may be affected by wire rope strength.  
Maximum lifting capacity per line (Main & Aux.): 14,600 lbs (6,600 kg)

- Line speeds based only on hook block, not loaded.
- Developed by machinery with each layer of wire rope, but not based on rope strength or other limitation in machinery or equipment.
- Seventh layer of wire rope are not recommended for hoisting operations.

## DRUM WIRE ROPE CAPACITIES

Wire rope layer	Main and auxiliary drum grooved lagging			
	3/4" (19mm) wire rope			
	Rope per layer		Total wire rope	
	Feet	Meters	Feet	Meters
1	112.2	34.2	112.2	34.2
2	122.3	37.3	234.5	71.5
3	132.2	40.3	366.8	111.8
4	142.3	43.4	509.1	155.2
5	152.2	46.4	661.4	201.6
6	162.4	49.5	823.8	251.1
7	172.5	52.6	996.4	303.7

## DRUM DIMENSIONS

	Inch	mm
Root diameter	14-1/4"	362
Length	23-5/8"	600
Flange diameter	25-7/8"	657

# GR-1000XL WORKING RANGE CHART

Telescoping mode I

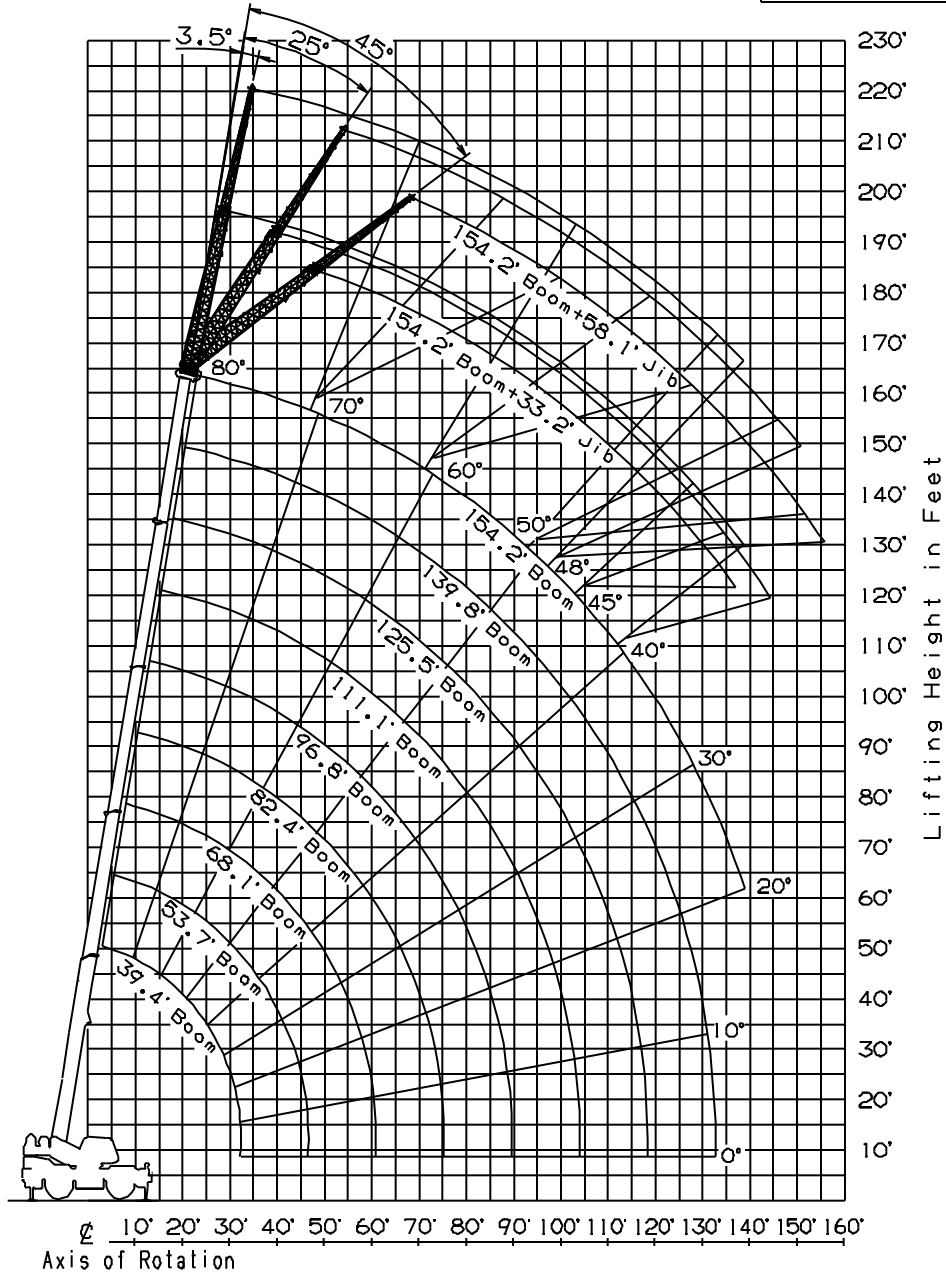

Axis of Rotation  
Load Radius from Axis of Rotation in Feet

Boom Length in Feet

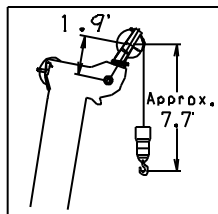
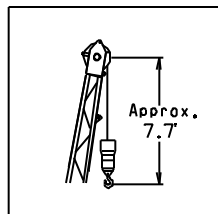
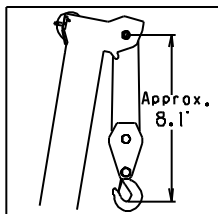

NOTE: 1. Boom and jib geometry shown are for unloaded condition and machine standing level on firm supporting surface.  
Boom deflection and subsequent radius and boom angle change must be accounted for when applying load to hook.

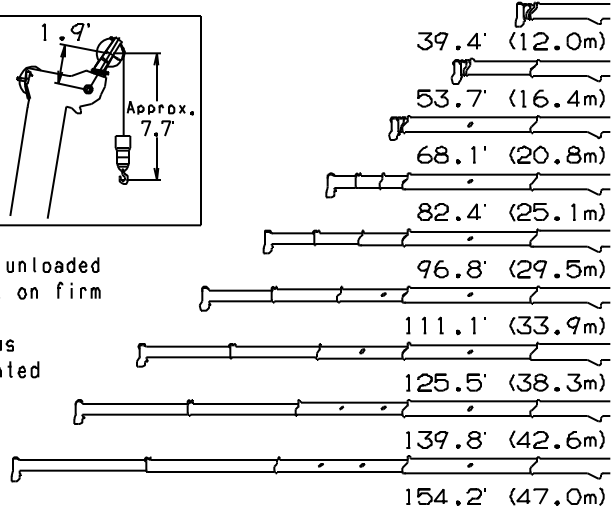

# GR-1000XL WORKING RANGE CHART

Telescoping mode II

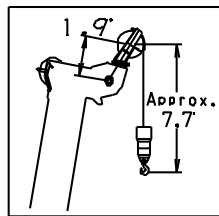
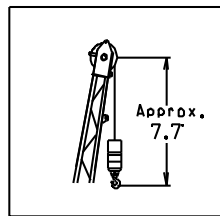
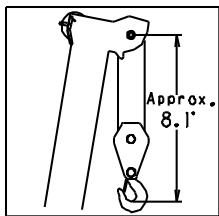
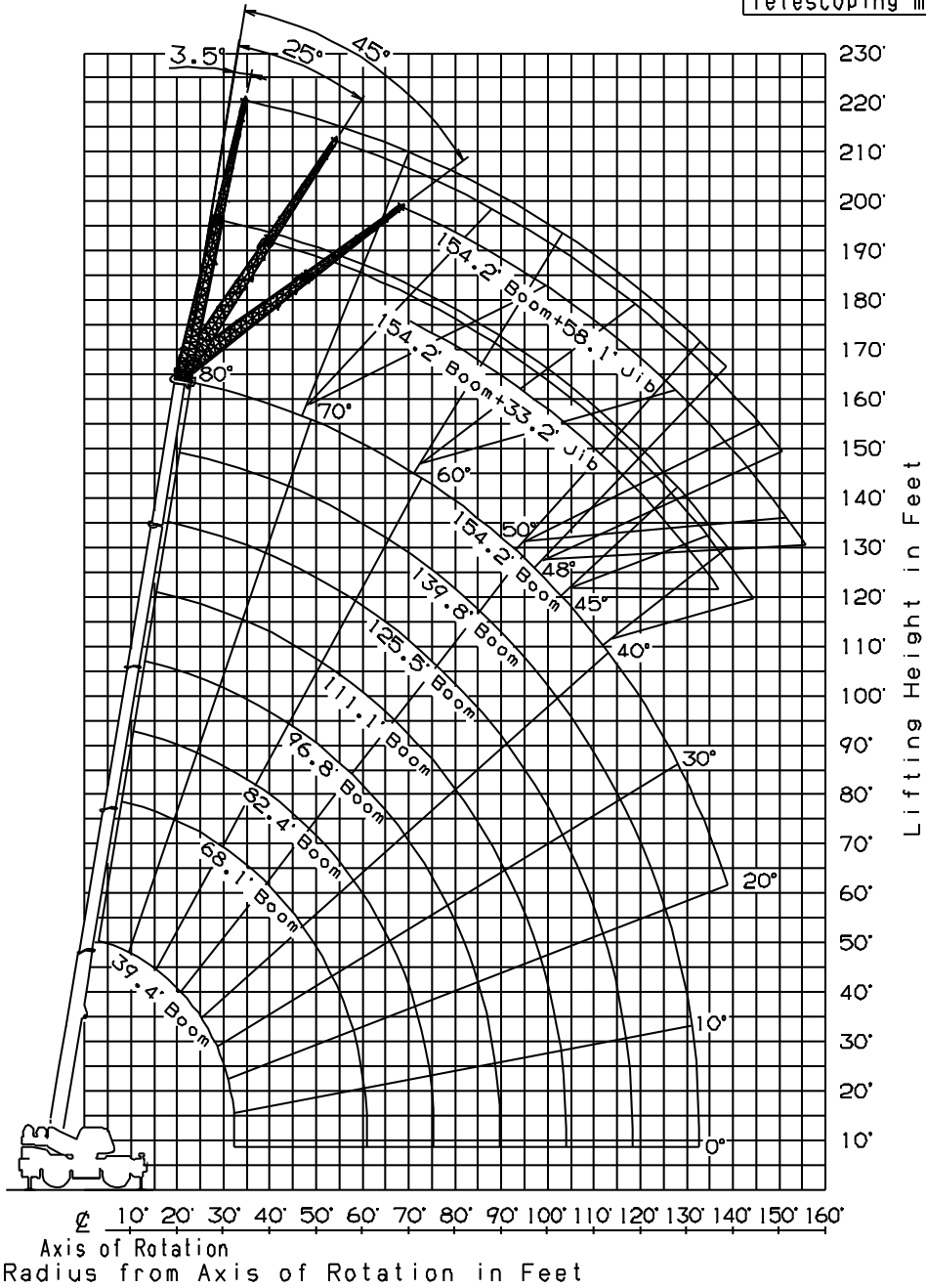

Boom Length in Feet

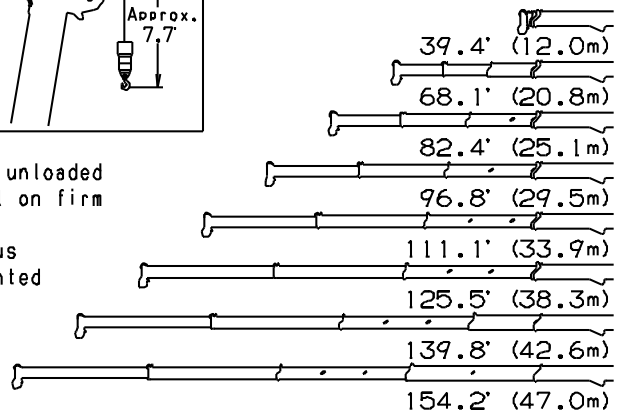

NOTE: 1. Boom and jib geometry shown are for unloaded condition and machine standing level on firm supporting surface.  
Boom deflection and subsequent radius and boom angle change must be accounted for when applying load to hook.

# GR-1000XL RATED LIFTING CAPACITIES (IN POUNDS)

ON OUTRIGGERS FULLY EXTENDED 23' 11-3/8"(7.3m) SPREAD																														
360° ROTATION																														
A	39.4'		53.7'		68.1' (20.8m)		82.4' (25.1m)		96.8' (29.5m)		111.1' (33.9m)		125.5' (38.3m)		139.8' (42.6m)		154.2'													
	B	C (12m)	C (16.4m)	C	C	C	C	C	C	C	C	C	C	C	C	C	C	C (47m)												
8'	73	200,000	78	102,700																										
10'	70	180,000	76	102,700	80	90,200	79	40,100																						
12'	67	157,900	74	102,700	78	90,200	77	40,100																						
15'	61	132,300	70	102,700	75	89,900	75	40,100	78	42,500	78	35,500																		
20'	52	99,700	64	99,100	71	76,100	70	40,100	74	42,500	74	35,500	77	40,100	77	33,300	79	35,500	79	32,200										
25'	41	76,900	58	76,200	66	65,600	65	40,100	71	42,500	70	35,500	74	40,100	74	33,300	77	35,500	77	32,200	79	33,300	79	28,700						
30'	25	50,700	51	57,700	61	56,700	60	40,100	67	42,500	67	35,500	71	40,100	71	33,300	74	35,500	74	30,200	77	33,300	77	26,300	79	26,700	79	24,300		
35'			43	42,800	56	41,800	55	40,100	63	42,500	63	35,500	68	39,500	68	31,600	72	35,100	72	27,300	74	30,900	74	24,000	77	26,700	77	24,100	78	20,900
40'			33	33,100	50	32,100	49	36,400	59	34,100	59	35,500	65	34,000	65	29,300	69	32,000	69	24,900	72	28,400	72	22,000	75	25,300	75	22,300	77	20,900
45'			18	26,200	44	25,400	43	31,100	54	27,300	54	31,800	61	28,300	61	26,500	66	28,000	66	22,900	69	26,100	69	20,200	72	23,500	73	20,700	75	20,700
50'					37	20,400	36	25,900	49	22,200	49	26,600	57	23,200	58	24,100	63	24,000	63	21,300	67	22,900	67	18,700	70	21,800	71	19,300	73	19,400
55'					28	16,600	27	20,900	44	18,400	44	22,600	54	19,300	54	22,200	59	20,100	60	19,600	64	20,100	64	17,400	68	19,600	68	18,000	71	18,100
60'					13	13,600	12	15,900	39	15,300	38	19,400	49	16,200	50	19,700	56	17,000	57	18,200	61	17,300	62	16,100	66	17,400	66	16,800	69	16,800
65'									32	12,700	32	16,800	45	13,700	45	17,100	53	14,400	53	16,600	58	14,800	59	15,000	63	15,300	64	15,800	67	15,200
70'									24	10,600	23	14,600	40	11,600	41	15,000	49	12,300	50	15,200	56	12,700	56	13,800	61	13,200	61	14,300	65	13,400
75'									7	8,900	5	11,700	35	9,800	35	13,200	45	10,600	46	13,400	53	10,900	53	12,700	58	11,400	59	12,500	62	11,700
80'													29	8,300	29	11,600	41	9,100	42	11,900	49	9,500	50	11,700	55	9,900	56	11,000	60	10,200
85'													21	7,100	21	10,300	37	7,800	38	10,500	46	8,200	46	10,800	53	8,600	53	9,700	58	8,900
90'																	31	6,600	33	9,400	42	7,000	43	9,600	50	7,500	50	8,600	55	7,700
95'																	25	5,600	27	8,400	38	6,000	39	8,600	47	6,500	47	7,600	53	6,700
100'																	17	4,800	19	7,500	34	5,200	35	7,700	43	5,600	44	6,700	50	5,900
105'																					29	4,400	30	6,900	40	4,800	41	5,900	47	5,100
110'																					24	3,700	24	6,200	37	4,100	37	5,200	44	4,300
115'																					15	3,100	15	5,600	33	3,500	32	4,500	41	3,700
120'																									27	2,900	28	4,000	38	3,200
125'																									22	2,400	23	3,500	34	2,600
130'																									14	2,000	14	3,100	30	2,200
135'																													26	1,800
D	0																20													

LIFTING CAPACITIES AT ZERO DEGREE BOOM ANGLE ON OUTRIGGERS FULLY EXTENDED																												
23' 11-3/8"(7.3m) SPREAD 360° ROTATION																												
A	39.4'		53.7'		68.1' (20.8m)		82.4' (25.1m)		96.8' (29.5m)		111.1' (33.9m)		125.5' (38.3m)		139.8' (42.6m)		C											
	B	(12m)	B (16.4m)	B	B	B	B	B	B	B	B	B	B	B	B	B												
0°	32.2'	30,900	46.6'	19,400	60.7'	12,100	60.5'	15,600	75.0'	8,900	75.0'	11,800	89.0'	6,200	89.0'	8,200	102.0'	4,400	103.0'	6,200	117.0'	3,000	116.0'	5,400	131.0'	2,000	130.0'	3,100
Tele. mode	I, II		I		I		II		I		II		I		II		I		II		I		II		I		II	

- A :Boom length in feet
- B :Load radius in feet
- C :Loaded boom angle (°)
- D :Minimum boom angle (°) for indicated length (no load)

NOTE The lifting capacity data stored in the LOAD MOMENT INDICATOR (AML-C) is based on the standard number of parts of line listed in the chart. Standard number of parts of line for each boom length should be according to the following table.

Boom length in feet (meters)	39.4' (12m)	39.4' to 68.1' (12m to 20.8m)		68.1' to 154.2' (20.8m to 47m)	Single top Jib
Telescoping mode	I, II	I	II	I, II	I, II
Number of parts of line	16	8	4	4	1





# GR-1000XL RATED LIFTING CAPACITIES (IN POUNDS)

ON OUTRIGGERS MID EXTENDED 21' 11-3/4"(6.7m) SPREAD																														
360° ROTATION																														
A B	39.4' (12m)		53.7' (16.4m)		68.1' (20.8m)		82.4' (25.1m)		96.8' (29.5m)		111.1' (33.9m)		125.5' (38.3m)		139.8' (42.6m)		154.2' (47m)													
	C	C	C	C	C	C	C	C	C	C	C	C	C	C	C	C	C													
8'	73	200,000	78	102,700																										
10'	70	175,700	76	102,700	80	90,200	79	40,100																						
12'	67	153,600	74	102,700	78	90,200	77	40,100																						
15'	61	128,200	70	102,700	75	89,900	75	40,100	78	42,500	78	35,500																		
20'	52	94,800	64	98,000	71	75,000	70	40,100	74	42,500	74	35,500	77	40,100	77	33,300	79	35,500	79	32,200										
25'	41	67,800	58	65,800	66	59,500	65	40,100	71	42,500	70	35,500	74	40,100	74	33,300	77	35,500	77	32,200	79	33,300	79	28,700						
30'	25	46,900	50	45,400	61	44,000	60	40,100	67	42,500	67	35,500	71	40,100	71	33,300	74	35,500	74	30,200	77	33,300	77	26,300	79	26,700	79	24,300		
35'			42	33,400	56	32,200	55	36,200	63	34,300	63	35,500	68	35,400	68	31,600	72	35,100	72	27,300	74	30,900	74	24,000	77	26,700	77	24,100	78	20,900
40'			33	25,400	50	24,400	50	30,400	58	26,400	58	31,100	65	27,500	65	29,300	69	28,300	69	24,900	72	28,400	72	22,000	75	25,300	75	22,300	77	20,900
45'			18	19,800	44	18,900	43	24,600	54	20,800	54	25,300	61	21,800	61	25,600	65	22,600	66	22,900	69	23,100	69	20,200	72	23,500	73	20,700	75	20,700
50'					37	14,800	36	20,300	49	16,700	49	21,000	57	17,700	57	21,300	62	18,400	63	20,400	67	18,900	67	18,700	70	19,300	71	19,300	73	19,400
55'					28	11,600	27	17,000	44	13,400	44	17,600	53	14,500	54	18,000	59	15,200	60	18,000	64	15,700	64	17,400	68	16,100	68	17,300	71	16,400
60'					13	9,200	12	14,300	38	10,800	38	14,900	49	11,900	49	15,400	56	12,600	56	15,600	64	13,100	64	15,700	65	13,400	66	14,700	69	13,700
65'								32	8,700	32	12,800	45	9,700	45	13,200	52	10,500	53	13,400	58	11,000	59	13,600	63	11,300	63	12,500	67	11,600	
70'								23	7,000	23	11,000	40	8,000	40	11,400	49	8,700	49	11,600	55	9,200	56	11,800	60	9,600	61	10,700	64	9,900	
75'								5	5,600	5	9,500	35	6,500	35	9,900	45	7,200	45	10,100	52	7,700	53	10,300	57	8,100	58	9,300	62	8,400	
80'										29	5,200	29	8,600	41	5,900	41	8,800	49	6,400	49	9,000	55	6,800	55	8,800	60	6,900	60	7,100	
85'										21	4,200	21	7,500	36	4,800	37	7,700	46	5,300	46	7,800	52	5,700	52	6,900	57	6,000	57	6,000	
90'														31	3,900	32	6,700	42	4,400	42	6,900	49	4,700	49	5,900	55	5,000	55	5,000	
95'														25	3,100	25	5,900	38	3,500	38	6,000	46	3,900	46	5,000	52	4,200	52	4,200	
100'														16	2,400	16	5,200	34	2,800	34	5,200	43	3,200	43	4,300	50	3,400	50	3,400	
105'																		29	2,100	29	4,600	40	2,500	40	3,600	47	2,800	47	2,800	
110'																		24	1,600	23	4,000	36	1,900	36	3,000	44	2,200	44	2,200	
115'																				14	3,500	32	1,400	32	2,400	41	1,600	41	1,600	
120'																										27	2,000			
125'																										21	1,600			
D	0													27	11	38														
Telescoping conditions (%)																														
Tele. mode	I, II	I	I	II	I	II	I	II	I	II	I	II	I	II	I	II														
2nd boom	0	50	100	0	100	0	100	0	100	0	100	0	100	0	100	50	100													
3rd boom	0	0	0	33	16	50	33	66	50	83	66	100	83	100	83	100	100													
4th boom	0	0	0	33	16	50	33	66	50	83	66	100	83	100	83	100	100													
Top boom	0	0	0	33	16	50	33	66	50	83	66	100	83	100	83	100	100													

LIFTING CAPACITIES AT ZERO DEGREE BOOM ANGLE ON OUTRIGGERS MID EXTENDED																								
21' 11-3/4"(6.7m) SPREAD 360° ROTATION																								
A C	39.4' (12m)		53.7' (16.4m)		68.1' (20.8m)		82.4' (25.1m)		96.8' (29.5m)		111.1' (33.9m)		125.5' (38.3m)											
	B	B	B	B	B	B	B	B	B	B	B	B	B	B										
0	32.2°	28,300	45.5°	18,300	60.7°	8,900	60.6°	14,100	75.0°	5,600	75.0°	9,500	89.2°	3,400	89.1°	6,700	103.0°	2,000	102.0°	4,900	117.0°	800	116.0°	3,300
Tele. mode	I, II	I	I	II	I	II	I	II	I	II	I	II	I	II										

- A :Boom length in feet
- B :Load radius in feet
- C :Loaded boom angle (°)
- D :Minimum boom angle (°) for indicated length (no load)

NOTE The lifting capacity data stored in the LOAD MOMENT INDICATOR (AML-C) is based on the standard number of parts of line listed in the chart.  
Standard number of parts of line for each boom length should be according to the following table.

Boom length in feet (meters)	39.4' (12m)	39.4' to 68.1' (12m to 20.8m)	68.1' to 154.2' (20.8m to 47m)	Single top Jib
Telescoping mode	I, II	I	II	I, II
Number of parts of line	16	8	4	1

# GR-1000XL RATED LIFTING CAPACITIES (IN POUNDS)

ON OUTRIGGERS MID EXTENDED 21' 11-3/4"(6.7m) SPREAD													
360° ROTATION													
C	154.2' (47.0m) Boom + 33.2' (10.1m) Jib						C	154.2' (47.0m) Boom + 58.1' (17.7m) Jib					
	3.5° offset		25° offset		45° offset			3.5° offset		25° offset		45° offset	
	R	W	R	W	R	W		R	W	R	W	R	W
80	37.8'	10,800	51.5'	10,800	58.8'	9,400	80	45.8'	6,800	71.7'	6,300	83.5'	5,100
79	41.5'	10,800	55.3'	10,400	62.2'	9,200	79	50.0'	6,800	75.5'	6,200	87.1'	5,100
78	45.2'	10,800	58.6'	10,200	65.7'	9,000	78	54.2'	6,800	79.1'	6,000	90.3'	5,000
77	49.2'	10,800	62.1'	9,900	68.4'	8,800	77	58.5'	6,800	82.7'	5,900	93.3'	5,000
76	52.6'	10,800	65.3'	9,600	71.6'	8,700	76	62.7'	6,800	86.4'	5,800	96.2'	4,900
75	56.3'	10,800	69.0'	9,300	74.5'	8,500	75	66.8'	6,800	90.0'	5,700	99.5'	4,800
73	63.5'	10,500	75.2'	8,900	80.5'	8,200	73	74.6'	6,800	96.7'	5,500	105.0'	4,700
70	73.4'	9,600	84.5'	8,300	88.8'	7,700	70	87.2'	6,800	107.0'	5,200	113.0'	4,600
68	79.0'	8,700	89.8'	7,700	94.0'	7,000	68	93.8'	6,300	113.0'	5,100	119.0'	4,500
65	86.7'	6,700	96.9'	6,000	101.0'	5,600	65	102.0'	4,700	120.0'	4,000	125.0'	3,700
63	91.8'	5,600	102.0'	5,100	105.0'	4,700	63	108.0'	3,800	125.0'	3,300	130.0'	3,100
60	99.3'	4,300	109.0'	3,900	112.0'	3,700	60	116.0'	2,800	133.0'	2,400	137.0'	2,300
58	104.0'	3,500	114.0'	3,300	116.0'	3,100	58	121.0'	2,200	138.0'	1,900	141.0'	1,800
55	112.0'	2,600	121.0'	2,400	122.0'	2,300	55	129.0'	1,400	145.0'	1,300	147.0'	1,200
53	116.0'	2,100	125.0'	1,900	126.0'	1,800	53	134.0'	1,000				
50	123.0'	1,400	131.0'	1,300	132.0'	1,200							
48	128.0'	1,000											

ON OUTRIGGERS MID EXTENDED 21' 11-3/4"(6.7m) SPREAD													
360° ROTATION													
C	139.8'(42.6m) Boom(telescoping model) + 33.2' (10.1m) Jib						C	139.8'(42.6m) Boom(telescoping model) + 58.1' (17.7m) Jib					
	3.5° offset		25° offset		45° offset			3.5° offset		25° offset		45° offset	
	R	W	R	W	R	W		R	W	R	W	R	W
80	32.7'	11,700	45.8'	11,600	53.0'	10,000	80	40.8'	7,300	64.6'	6,500	77.3'	5,200
79	36.4'	11,700	49.0'	11,200	55.8'	9,800	79	44.7'	7,300	67.9'	6,400	80.4'	5,100
78	39.6'	11,700	52.1'	10,900	59.1'	9,600	78	48.7'	7,300	72.0'	6,200	83.5'	5,100
77	43.0'	11,700	55.0'	10,600	61.6'	9,400	77	52.6'	7,300	75.2'	6,100	86.2'	5,000
76	46.4'	11,700	57.7'	10,300	64.1'	9,200	76	56.5'	7,300	78.1'	6,000	89.2'	5,000
75	49.4'	11,700	60.9'	10,100	67.0'	9,100	75	60.0'	7,300	81.8'	5,900	92.4'	5,000
73	55.8'	11,500	67.0'	9,500	72.6'	8,700	73	67.0'	7,300	88.2'	5,700	97.7'	4,900
70	65.1'	10,400	75.1'	8,900	80.1'	8,200	70	78.3'	7,300	97.5'	5,400	105.0'	4,700
68	70.4'	9,700	80.6'	8,400	84.9'	7,800	68	85.2'	7,100	103.0'	5,300	110.0'	4,600
65	78.4'	8,600	88.1'	7,500	91.7'	7,100	65	94.2'	6,200	112.0'	5,100	118.0'	4,600
63	83.7'	7,900	93.0'	7,000	96.4'	6,700	63	99.8'	5,700	117.0'	4,700	123.0'	4,400
60	91.1'	6,600	99.4'	6,000	102.0'	5,600	60	108.0'	4,700	124.0'	4,000	129.0'	3,800
58	95.6'	5,800	104.0'	5,200	106.0'	5,000	58	113.0'	4,000	128.0'	3,400	133.0'	3,300
55	102.0'	4,700	110.0'	4,300	112.0'	4,100	55	120.0'	3,100	135.0'	2,700	139.0'	2,600
53	107.0'	4,100	114.0'	3,700	116.0'	3,600	53	125.0'	2,600	139.0'	2,300	142.0'	2,200
50	113.0'	3,300	120.0'	3,000	121.0'	2,900	50	132.0'	2,000	145.0'	1,800	147.0'	1,700
48	117.0'	2,800	124.0'	2,600	125.0'	2,600	48	137.0'	1,600	149.0'	1,500	151.0'	1,400
45	123.0'	2,200	129.0'	2,100	129.0'	2,100	45	143.0'	1,200	155.0'	1,000	155.0'	1,000
43	127.0'	1,900	132.0'	1,800									
40	132.0'	1,500	137.0'	1,400									
38	136.0'	1,200	140.0'	1,100									

ON OUTRIGGERS MID EXTENDED 21' 11-3/4"(6.7m) SPREAD													
360° ROTATION													
C	125.5'(38.3m) Boom(telescoping model) + 33.2' (10.1m) Jib						C	125.5'(38.3m) Boom(telescoping model) + 58.1' (17.7m) Jib					
	3.5° offset		25° offset		45° offset			3.5° offset		25° offset		45° offset	
	R	W	R	W	R	W		R	W	R	W	R	W
80	30.5'	14,600	43.5'	14,000	50.1'	10,700	80	37.2'	8,800	58.7'	7,000	71.2'	5,200
79	33.3'	14,600	46.0'	13,600	52.6'	10,600	79	41.2'	8,800	61.5'	6,800	73.9'	5,100
78	36.0'	14,600	49.2'	13,300	55.1'	10,500	78	44.8'	8,800	65.4'	6,700	76.8'	5,100
77	39.0'	14,600	51.7'	12,900	57.6'	10,300	77	47.8'	8,800	68.4'	6,500	79.5'	5,000
76	42.6'	14,600	54.1'	12,700	60.1'	10,200	76	51.3'	8,800	70.8'	6,400	82.1'	5,000
75	45.5'	14,600	56.9'	12,400	62.7'	10,100	75	54.9'	8,800	74.3'	6,300	84.9'	5,000
73	51.2'	14,600	62.4'	11,900	67.5'	10,000	73	61.6'	8,800	80.5'	6,100	90.0'	4,900
70	59.8'	13,700	70.0'	11,200	74.6'	9,700	70	71.3'	8,300	88.9'	5,800	97.5'	4,700
68	64.6'	13,000	74.9'	10,800	78.8'	9,600	68	77.2'	7,900	94.6'	5,600	102.0'	4,600
65	71.7'	10,700	81.2'	9,000	84.9'	8,400	65	86.1'	7,500	102.0'	5,400	109.0'	4,600
63	76.3'	9,200	85.4'	7,800	88.8'	7,400	63	91.5'	6,500	107.0'	5,300	113.0'	4,500
60	82.7'	7,400	91.5'	6,400	94.6'	6,100	60	98.5'	5,100	114.0'	4,400	120.0'	4,100
58	86.8'	6,400	95.3'	5,600	98.1'	5,400	58	104.0'	4,400	118.0'	3,700	123.0'	3,600
55	93.1'	5,200	101.0'	4,600	104.0'	4,400	55	111.0'	3,400	124.0'	3,000	129.0'	2,900
53	97.2'	4,500	105.0'	4,000	107.0'	3,900	53	115.0'	2,900	129.0'	2,500	132.0'	2,400
50	103.0'	3,600	110.0'	3,200	112.0'	3,200	50	122.0'	2,200	134.0'	1,900	137.0'	1,900
48	107.0'	3,100	114.0'	2,800	115.0'	2,700	48	126.0'	1,800	138.0'	1,600	140.0'	1,500
45	112.0'	2,400	119.0'	2,200	120.0'	2,100	45	132.0'	1,300	143.0'	1,100	144.0'	1,100
43	116.0'	2,000	122.0'	1,800									
40	121.0'	1,500	126.0'	1,400									
38	124.0'	1,200	129.0'	1,100									

C :Loaded boom angle (°)  
R :Load radius in feet  
W :Rated lifting capacity in pounds

# GR-1000XL RATED LIFTING CAPACITIES (IN POUNDS)

ON OUTRIGGERS MID EXTENDED 18' 1/2"(5.5m) SPREAD																														
360° ROTATION																														
A B	39.4' (12m)		53.7' (16.4m)		68.1' (20.8m)		82.4' (25.1m)		96.8' (29.5m)		111.1' (33.9m)		125.5' (38.3m)		139.8' (42.6m)		154.2' (47m)													
	C	C	C	C	C	C	C	C	C	C	C	C	C	C	C	C	C													
8'	73	191,600	78	102,700																										
10'	70	164,000	76	102,700	80	90,200	79	40,100																						
12'	67	142,400	74	102,700	78	90,200	77	40,100																						
15'	61	113,500	70	102,700	75	89,900	75	40,100	78	42,500	78	35,500																		
20'	52	75,400	64	73,400	71	67,200	70	40,100	74	42,500	74	35,500	77	40,100	77	33,300	79	35,500	79	32,200										
25'	41	48,200	57	46,700	66	45,400	65	40,100	71	42,500	70	35,500	74	40,100	74	33,300	77	35,500	77	32,200	79	33,300	79	28,700						
30'	25	33,900	50	32,700	61	31,500	60	35,500	67	33,600	67	35,500	71	34,800	71	33,300	74	35,500	74	30,200	77	33,300	77	26,300	79	26,700	79	24,300		
35'			42	23,900	55	23,000	55	28,900	63	24,900	62	29,500	68	26,000	68	29,900	71	26,800	72	27,300	74	27,300	74	24,000	77	26,700	77	24,100	78	20,900
40'			33	18,000	50	17,100	50	22,800	58	19,000	58	23,400	64	20,100	64	23,800	68	20,800	69	24,100	71	21,400	72	22,000	74	21,800	75	22,300	77	20,900
45'			18	13,700	44	12,900	43	18,300	54	14,800	54	19,000	61	15,800	61	19,400	65	16,500	65	19,600	69	17,000	69	19,800	72	17,400	72	18,700	75	17,700
50'					36	9,700	36	14,900	49	11,500	49	15,600	57	12,600	57	16,000	62	13,200	62	16,300	66	13,800	67	16,400	70	14,100	70	15,300	73	14,400
55'					27	7,200	27	12,300	44	8,900	44	13,000	53	10,000	53	13,400	59	10,700	59	13,700	63	11,200	64	13,800	67	11,600	68	12,700	70	11,900
60'					12	5,300	12	10,300	38	6,900	38	9,900	49	7,900	49	11,300	55	8,600	56	11,600	61	9,100	61	11,700	65	9,500	65	10,700	68	9,800
65'									32	5,200	32	9,100	45	6,200	45	9,500	52	6,900	52	9,800	58	7,500	58	10,000	62	7,800	63	9,000	66	8,100
70'									23	3,800	23	7,700	40	4,800	40	8,100	48	5,500	49	8,300	55	6,000	55	8,500	60	6,400	60	7,500	64	6,700
75'									6	2,600	5	6,500	35	3,600	35	6,800	45	4,300	45	7,100	52	4,800	52	7,300	57	5,200	57	6,300	61	5,500
80'												29	2,600	28	5,800	41	3,200	41	6,000	49	3,700	49	6,200	55	4,100	55	5,200	59	4,400	
85'												21	1,700	20	4,900	36	2,300	36	5,100	45	2,800	46	5,300	52	3,200	52	4,300	57	3,500	
90'															31	1,600	31	4,300	42	2,100	42	4,500	49	2,400	49	3,500	54	2,700		
95'																	25	3,700	38	1,400	38	3,800	46	1,700	46	2,800	52	2,000		
100'																	16	3,100			34	3,200	43	1,100	43	2,200	49	1,400		
105'																					29	2,600			40	1,700				
110'																					23	2,200			36	1,100				
115'																					14	1,700								
D	0										18		0		29		0		40		27		47							
Telescoping conditions (%)																														
Tele. mode	I, II	I	I	II	I	II	I	II	I	II	I	II	I	II	I	II	I, II													
2nd boom	0	50	100	0	100	0	100	0	100	0	100	0	100	0	100	50	100													
3rd boom	0	0	0	33	16	50	33	66	50	83	66	100	83	100	83	100	100													
4th boom	0	0	0	33	16	50	33	66	50	83	66	100	83	100	83	100	100													
Top boom	0	0	0	33	16	50	33	66	50	83	66	100	83	100	83	100	100													

LIFTING CAPACITIES AT ZERO DEGREE BOOM ANGLE ON OUTRIGGERS MID EXTENDED																
18' 1/2"(5.5m) SPREAD 360° ROTATION																
A C	39.4' (12m)		53.7' (16.4m)		68.1' (20.8m)		82.4' (25.1m)		96.8' (29.5m)		111.1' (33.9m)		125.5' (38.3m)			
	B	B	B	B	B	B	B	B	B	B	B	B	B	B	B	B
0	32.2°	29,200	46.4°	12,600	60.7°	5,000	60.7°	10,000	75.0°	2,600	75.0°	6,500	89.2°	1,100	89.1°	4,300
Tele. mode	I, II	I	I	II	I	II	I	II	I	II	II	II	II	II	II	

- A :Boom length in feet
- B :Load radius in feet
- C :Loaded boom angle (°)
- D :Minimum boom angle (°) for indicated length (no load)

NOTE The lifting capacity data stored in the LOAD MOMENT INDICATOR (AML-C) is based on the standard number of parts of line listed in the chart.  
Standard number of parts of line for each boom length should be according to the following table.

Boom length in feet (meters)	39.4' (12m)	39.4' to 68.1' (12m to 20.8m)	68.1' to 154.2' (20.8m to 47m)	Single top Jib	
Telescoping mode	I, II	I	II	I, II	
Number of parts of line	16	8	4	4	1

# GR-1000XL RATED LIFTING CAPACITIES (IN POUNDS)

ON OUTRIGGERS MID EXTENDED 18' 1/2"(5.5m) SPREAD													
360° ROTATION													
C	154.2' (47.0m) Boom + 33.2' (10.1m) Jib						154.2' (47.0m) Boom + 58.1' (17.7m) Jib						
	3.5° offset		25° offset		45° offset		3.5° offset		25° offset		45° offset		
	R	W	R	W	R	W	R	W	R	W	R	W	
80	37.8'	10,800	51.5'	10,800	58.8'	9,400	80	45.8'	6,800	71.7'	6,300	83.5'	5,100
79	41.5'	10,800	55.3'	10,400	62.2'	9,200	79	50.0'	6,800	75.5'	6,200	87.1'	5,100
78	45.2'	10,800	58.6'	10,200	65.7'	9,000	78	54.2'	6,800	79.1'	6,000	90.3'	5,000
77	49.2'	10,800	62.1'	9,900	68.4'	8,800	77	58.5'	6,800	82.7'	5,900	93.3'	5,000
76	52.6'	10,800	65.3'	9,600	71.6'	8,700	76	62.7'	6,800	86.4'	5,800	96.2'	4,900
75	56.3'	10,800	69.0'	9,300	74.5'	8,500	75	66.8'	6,800	90.0'	5,700	99.5'	4,800
73	63.2'	10,100	74.4'	8,300	80.1'	7,600	73	74.6'	6,800	96.7'	5,500	105.0'	4,700
70	71.2'	7,400	82.4'	6,200	87.4'	5,700	70	84.5'	5,200	105.0'	4,200	112.0'	3,800
68	76.6'	6,000	87.3'	5,000	92.0'	4,700	68	90.3'	4,100	109.0'	3,300	117.0'	3,000
65	84.6'	4,300	95.2'	3,700	98.9'	3,500	65	98.8'	2,700	117.0'	2,300	123.0'	2,100
63	90.0'	3,400	100.0'	2,900	103.0'	2,800	63	105.0'	2,000	122.0'	1,700	128.0'	1,600
60	97.6'	2,300	107.0'	2,000	110.0'	1,900	60	113.0'	1,100				
58	103.0'	1,700	112.0'	1,400	115.0'	1,400							

ON OUTRIGGERS MID EXTENDED 18' 1/2"(5.5m) SPREAD													
360° ROTATION													
C	139.8'(42.6m) Boom(telescoping modelII) + 33.2' (10.1m) Jib						139.8'(42.6m) Boom(telescoping modelII) + 58.1' (17.7m) Jib						
	3.5° offset		25° offset		45° offset		3.5° offset		25° offset		45° offset		
	R	W	R	W	R	W	R	W	R	W	R	W	
80	32.7'	11,700	45.8'	11,600	53.0'	10,000	80	40.8'	7,300	64.6'	6,500	77.3'	5,200
79	36.4'	11,700	49.0'	11,200	55.8'	9,800	79	44.7'	7,300	67.9'	6,400	80.4'	5,100
78	39.6'	11,700	52.1'	10,900	59.1'	9,600	78	48.7'	7,300	72.0'	6,200	83.5'	5,100
77	43.0'	11,700	55.0'	10,600	61.6'	9,400	77	52.6'	7,300	75.2'	6,100	86.2'	5,000
76	46.4'	11,700	57.7'	10,300	64.1'	9,200	76	56.5'	7,300	78.1'	6,000	89.2'	5,000
75	49.4'	11,700	60.9'	10,100	67.0'	9,100	75	60.0'	7,300	81.8'	5,900	92.4'	5,000
73	55.8'	11,500	67.0'	9,500	72.6'	8,700	73	67.0'	7,300	88.2'	5,700	97.7'	4,900
70	64.6'	10,200	74.9'	8,600	79.7'	7,800	70	78.3'	7,300	97.5'	5,400	105.0'	4,700
68	69.3'	8,500	79.7'	7,300	84.0'	6,700	68	83.8'	6,100	103.0'	5,000	110.0'	4,400
65	76.8'	6,600	86.4'	5,800	90.4'	5,400	65	91.6'	4,600	110.0'	3,900	116.0'	3,400
63	81.8'	5,600	91.1'	4,900	94.7'	4,600	63	97.1'	3,800	114.0'	3,200	120.0'	2,800
60	89.1'	4,300	97.6'	3,800	101.0'	3,600	60	105.0'	2,800	121.0'	2,400	127.0'	2,100
58	93.6'	3,600	102.0'	3,200	105.0'	3,000	58	110.0'	2,200	126.0'	1,900	131.0'	1,700
55	101.0'	2,700	108.0'	2,400	111.0'	2,300	55	118.0'	1,500	133.0'	1,300	137.0'	1,200
53	105.0'	2,200	113.0'	2,000	115.0'	1,900	53	123.0'	1,100				
50	111.0'	1,500	119.0'	1,400	120.0'	1,300							
48	116.0'	1,100	122.0'	1,000	124.0'	1,000							

ON OUTRIGGERS MID EXTENDED 18' 1/2"(5.5m) SPREAD													
360° ROTATION													
C	125.5'(38.3m) Boom(telescoping model) + 33.2' (10.1m) Jib						125.5'(38.3m) Boom(telescoping model) + 58.1' (17.7m) Jib						
	3.5° offset		25° offset		45° offset		3.5° offset		25° offset		45° offset		
	R	W	R	W	R	W	R	W	R	W	R	W	
80	30.5'	14,600	43.5'	14,000	50.1'	10,700	80	37.2'	8,800	58.7'	7,000	71.2'	5,200
79	33.3'	14,600	46.0'	13,600	52.6'	10,600	79	41.2'	8,800	61.5'	6,800	73.9'	5,100
78	36.0'	14,600	49.2'	13,300	55.1'	10,500	78	44.8'	8,800	65.4'	6,700	76.8'	5,100
77	39.0'	14,600	51.7'	12,900	57.6'	10,300	77	47.8'	8,800	68.4'	6,500	79.5'	5,000
76	42.6'	14,600	54.1'	12,700	60.1'	10,200	76	51.3'	8,800	70.8'	6,400	82.1'	5,000
75	45.5'	14,600	56.9'	12,400	62.7'	10,100	75	54.9'	8,800	74.3'	6,300	84.9'	5,000
73	51.2'	14,600	62.4'	11,900	67.5'	10,000	73	61.6'	8,800	80.5'	6,100	90.0'	4,900
70	58.2'	11,300	68.9'	9,500	73.7'	8,600	70	71.3'	8,300	88.9'	5,800	97.5'	4,700
68	63.0'	9,500	73.2'	8,100	77.8'	7,400	68	76.1'	6,900	94.0'	5,500	102.0'	4,600
65	69.9'	7,300	79.6'	6,300	83.5'	5,900	65	84.0'	5,200	101.0'	4,200	108.0'	3,900
63	74.5'	6,100	83.7'	5,400	87.5'	5,000	63	89.2'	4,300	105.0'	3,500	112.0'	3,300
60	81.0'	4,700	90.0'	4,200	93.5'	3,900	60	96.6'	3,100	112.0'	2,600	118.0'	2,500
58	85.4'	3,900	93.9'	3,500	97.1'	3,300	58	102.0'	2,500	116.0'	2,100	122.0'	2,000
55	91.8'	2,900	99.7'	2,600	103.0'	2,500	55	108.0'	1,700	123.0'	1,400	128.0'	1,400
53	95.7'	2,300	104.0'	2,100	106.0'	2,000	53	113.0'	1,200	127.0'	1,000	131.0'	1,000
50	102.0'	1,600	109.0'	1,500	111.0'	1,400							
48	105.0'	1,100	113.0'	1,100	114.0'	1,000							

C :Loaded boom angle (°)  
R :Load radius in feet  
W :Rated lifting capacity in pounds

# GR-1000XL RATED LIFTING CAPACITIES (IN POUNDS)

ON OUTRIGGERS MIN EXTENDED 8' 10-5/16"(2.7m) SPREAD																														
360° ROTATION																														
B	39.4'		53.7'		68.1' (20.8m)		82.4' (25.1m)		96.8' (29.5m)		111.1' (33.9m)		125.5' (38.3m)		139.8' (42.6m)		154.2'													
	A	C (12m)	C (16.4m)	C	C	C	C	C	C	C	C	C	C	C	C	C	C (47m)													
8'	73	143,900	78	102,700																										
10'	70	94,900	76	93,000	80	90,200	79	40,100																						
12'	66	66,900	73	65,200	78	63,700	77	40,100																						
15'	61	44,700	70	43,400	75	42,000	75	40,100	78	42,500	78	35,500																		
20'	52	26,300	64	25,400	70	24,300	70	30,400	74	26,400	74	31,000	77	27,500	77	31,400	79	28,300	79	31,700										
25'	41	17,000	57	16,100	65	15,300	65	20,900	70	17,200	70	21,500	74	18,200	74	21,800	76	18,900	76	22,100	78	19,500	78	22,300						
30'	25	11,400	50	10,400	60	9,600	60	14,900	66	11,600	66	15,700	70	12,500	70	16,000	73	13,200	73	16,200	75	13,800	76	16,400	78	14,100	78	15,300		
35'			42	6,600	55	5,800	55	10,900	62	7,700	62	11,600	67	8,700	67	12,100	70	9,400	70	12,300	73	9,900	73	12,500	75	10,300	76	11,400	77	10,500
40'			33	3,900	49	3,100	49	8,100	58	4,900	58	8,700	63	5,900	64	9,200	67	6,600	68	9,500	70	7,100	71	9,600	73	7,500	73	8,600	75	7,700
45'			18	1,800	43	1,100	43	5,900	53	2,800	53	6,500	60	3,700	60	7,000	64	4,500	64	7,300	68	5,000	68	7,500	71	5,400	71	6,500	73	5,600
50'							36	4,300	49	1,100	49	4,900	56	2,100	56	5,300	61	2,800	61	5,600	65	3,300	65	5,800	68	3,700	69	4,800	71	4,000
55'							27	2,900			44	3,500		53	3,900	58	1,500	58	4,200	63	2,000	63	4,400	66	2,400	66	3,500	69	2,700	
60'							13	1,900			38	2,400		49	2,800		55	3,100		60	3,300	64	1,300	64	2,300	64	2,300	67	1,500	
65'											31	1,500		44	1,900		52	2,200		57	2,300			62	1,400					
70'											40	1,100		48	1,400		54	1,500												
D	0		28		0		44		5		49		35		55		45		58		52		62		57		65			
Telescoping conditions (%)																														
Tele. mode	I, II	I	I	II	I	II	I	II	I	II	I	II	I	II	I	II	I, II													
2nd boom	0	50	100	0	100	0	100	0	100	0	100	0	100	0	100	0	100													
3rd boom	0	0	0	33	16	50	33	66	50	83	66	100	83	100	83	100	100													
4th boom	0	0	0	33	16	50	33	66	50	83	66	100	83	100	83	100	100													
Top boom	0	0	0	33	16	50	33	66	50	83	66	100	83	100	83	100	100													

LIFTING CAPACITIES AT ZERO DEGREE BOOM ANGLE ON OUTRIGGERS MIN EXTENDED																
8' 10-5/16"(2.7m)SPREAD 360° ROTATION																
C	39.4'		53.7'		68.1'											
	A	B (12m)	B (16.4m)	B (20.8m)	B (20.8m)											
0	32.2'	9,200	46.5'	1,300	60.8'	1,700										
Tele. mode	I, II	I		II												

- A :Boom length in feet
- B :Load radius in feet
- C :Loaded boom angle (°)
- D :Minimum boom angle (°) for indicated length (no load)

NOTE The lifting capacity data stored in the LOAD MOMENT INDICATOR (AML-C) is based on the standard number of parts of line listed in the chart.  
Standard number of parts of line for each boom length should be according to the following table.

Boom length in feet (meters)	39.4' (12m)	39.4' to 68.1' (12m to 20.8m)		68.1' to 154.2' (20.8m to 47m)	Single top Jib
Telescoping mode	I, II	I	II	I, II	I, II
Number of parts of line	16	8	4	4	1

# WARNING AND OPERATING INSTRUCTIONS FOR LIFTING CAPACITIES

## GENERAL

1. RATED LIFTING CAPACITIES apply only to the machine as originally manufactured and normally equipped by TADANO LTD. Modifications to the machine or use of optional equipment other than that specified can result in a reduction of capacity.
2. Hydraulic cranes can be hazardous if improperly operated or maintained. Operation and maintenance of this machine must be in compliance with information in the **Operation and Maintenance Manuals** supplied with the crane. If this manual is missing, order a replacement through the distributor.
3. The operator and other personnel associated with this machine shall fully acquaint themselves with the latest applicable ASME B30.5 safety standards for cranes as mentioned in OSHA CFR29 part 1926.

## SET UP

1. Rated lifting capacities on the load chart are the maximum allowable crane capacities. They are based on the machine standing level on firm supporting surface under ideal job conditions. Depending on the nature of the supporting surface, it may be necessary to have structural supports under the outrigger floats or tires to spread the loads to a larger surface.
2. For outrigger operation, outriggers shall be properly extended with tires free of supporting surface before operating crane.

## OPERATION

1. Rated lifting capacities have been tested to and meet minimum requirements of SAE J1063-Cantilevered Boom Crane Structures Method of Test.
2. Rated lifting capacities do not exceed 85 % of the tipping load on outriggers fully extended as determined by SAE J765-Crane Stability Test Code.  
Rated lifting capacities for partially extended outriggers are determined from the formula, Rated Lifting Capacities = (Tipping Load - 0.1 x Tip Reaction)/1.25.
3. Rated lifting capacities above bold lines in the chart are based on crane strength and those below, on its stability. They are based on actual load radius increased by boom deflection.
4. The weight of handling device such as hook blocks, slings, etc., must be considered as part of the load and must be deducted from the lifting capacities.
5. Rated lifting capacities are based on freely suspended loads and make no allowance for such factors as the effect of wind, sudden stopping of loads, supporting surface conditions, inflation of tires, operating speeds, side loads, etc. Side pull on the boom or jib is extremely dangerous. Such action can damage the boom, jib or slewing mechanism, and lead to overturning the crane.
6. Rated lifting capacities do not account for wind on lifted load or boom. We recommend against working under the condition that the load is out of control due to a strong wind. During boom lift, consider that the rated lifting capacity is reduced by 50% when the wind speed is 20mph(9m/s) to 27mph(12m/s); reduced by 70% when the wind speed is 27mph(12m/s) to 31mph(14m/s). If the wind speed is 31mph(14m/s) or over, stop operation. During jib lift, stop operation if the wind speed is 20mph(9m/s).
7. Rated lifting capacities at load radius shall not be exceeded. Do not tip the crane to determine allowable loads.
8. Do not operate at boom lengths, radii, or boom angle, where no capacities are shown. Crane may overturn without any load on the hook.
9. When boom length is between values listed, refer to the rated lifting capacities of the next longer and next shorter booms for the same radius. The lesser of the two rated lifting capacities shall be used.
10. When making lifts at a load radius not shown, use the next longer radius to determine allowable capacity.

11. Load per line should not exceed 14,600 lbs. (6,600kg) for main hoist and auxiliary hoist.
12. Check the actual number of parts of line with LOAD MOMENT INDICATOR (AML-C) before operation. Maximum lifting capacity is restricted by the number of parts of line of LOAD MOMENT INDICATOR (AML-C). Limited capacity is as determined from the formula, Single line pull for main hoist 14,600 lbs. (6,600kg) x number of parts of line.
13. The boom angle before loading should be greater to account for deflection. For rated lifting capacities, the loaded boom angle and the load radius is for reference only.
14. The 39.4' (12.0m) boom length capacities are based on boom fully retracted. If not fully retracted [less than 53.7' (16.4m) boom length], use the rated lifting capacities for the 53.7' (16.4m) boom length.
15. Extension or retraction of the boom with loads may be attempted within the limits of the RATED LIFTING CAPACITIES. The ability to telescope loads is limited by hydraulic pressure, boom angle, boom length, crane maintenance, etc.
16. For lifting capacity of single top, reduce the rated lifting capacities of relevant boom according to a weight reductions for auxiliary load handling equipment. Capacities of single top shall not exceed 14,600 lbs. (6,600kg) including main hook.
17. When base jib or top jib or both jib removing, jib state switch select removed.
18. When erecting and stowing jib, be sure to retain it by hand or by other means to prevent its free movement.
19. Use "ANTI-TWO BLOCK" disable switch when erecting and stowing jib and when stowing hook block. While the switch is pushed, the hoist does not stop, even when overwind condition occurs.
20. For boom length 154.2' (47.0m) or less and 125.5' (38.3m) or longer with jib, rated lifting capacities are determined by loaded boom angle only in the column headed "154.2' (47.0m)boom+jib". For boom length 125.5' (38.3m) or less with jib, rated lifting capacities are determined by loaded boom angle only in the column headed "125.5' (38.3m)boom+jib". For angles not shown, use the next lower loaded boom angle to determine allowable capacity.(Telescoping MODE I) For boom length 154.2' (47.0m) or less and 139.8' (42.6m) or longer with jib, rated lifting capacities are determined by loaded boom angle only in the column headed "154.2' (47.0m)boom+jib". For boom length 139.8' (42.6m) or less with jib, rated lifting capacities are determined by loaded boom angle only in the column headed "139.8' (42.6m)boom+jib". For angles not shown, use the next lower loaded boom angle to determine allowable capacity.(Telescoping MODE II)
21. When lifting a load by using jib (aux. hoist) and boom (main hoist) simultaneously, do the following:
  - Enter the operation status as jib operation, not as boom operation.
  - Before starting operation, make sure that mass of load is within rated lifting capacity for jib.
22. Before telescoping the boom, set the telescoping mode selector switch to MODE I or MODE II with the boom fully retracted. A change of the telescoping mode is not permissible when the boom has been partially or fully extended.
23. Crane operation is prohibited without full counterweight 22,000lbs. (10 ton) installed. Outriggers shall be extended 23'11 3/8" (7.3m) spread when installing or removing counterweight.

## DEFINITIONS

1. Load Radius: Horizontal distance from a projection of the axis of rotation to supporting surface before loading to the center of the vertical hoist line or tackle with load applied.
2. Loaded Boom Angle: The angle between the boom base section and the horizontal, after lifting the rated lifting capacity at the load radius.
3. Working Area: Area measured in a circular arc about the centerline of rotation.
4. Freely Suspended Load: Load hanging free with no direct external force applied except by the hoist line.
5. Side Load: Horizontal side force applied to the lifted load either on the ground or in the air.

# GR-1000XL RATED LIFTING CAPACITIES (IN POUNDS)

ON RUBBER																		
A	Stationary									Creep								
	Over Front						360° Rotation			Over Front								
	39.4'		68.1'		96.8'		39.4'		68.1'	96.8'		39.4'		68.1'	96.8'			
B	C	(12m)	C	(20.8m)	C	(29.5m)	C	(12m)	C	(20.8m)	C	(29.5m)	C	(12m)	C	(20.8m)	C	(29.5m)
12'	66	60,000					66	38,000					66	45,000				
15'	61	49,600					61	28,500					61	36,600				
20'	52	37,500	70	35,000			52	17,500	70	20,000			52	26,800	70	29,200		
25'	41	28,500	65	29,500	74	22,900	40	10,400	65	14,000	73	14,000	40	20,500	65	22,800	74	22,900
30'	25	21,500	60	24,000	71	21,500	25	6,500	60	9,500	70	10,000	25	15,600	60	18,200	71	18,900
35'			55	19,200	67	19,500			55	6,500	67	7,400			55	14,800	67	15,500
40'			49	15,200	64	16,000			49	4,500	63	5,400			49	12,000	64	12,900
45'			43	12,200	60	13,000			43	3,000	60	3,900			43	9,800	60	10,600
50'			36	9,700	57	10,600			36	1,800	56	2,700			36	7,900	57	8,900
55'			27	8,000	53	8,800					53	1,700			27	6,500	53	7,300
60'			13	6,500	49	7,400									13	5,200	49	6,100
65'					45	6,100											44	5,000
70'					40	5,000											40	4,100
75'					35	4,100											34	3,200
80'					28	3,400											28	2,500
85'					20	2,700												
<b>D</b>	0						0			28		45		0				
Telescoping conditions (%)																		
Tele. mode	I, II		II		II		I, II		II		II		I, II		II		II	
2nd boom	0		0		0		0		0		0		0		0		0	
3rd boom	0		33		66		0		33		66		0		33		66	
4th boom	0		33		66		0		33		66		0		33		66	
Top boom	0		33		66		0		33		66		0		33		66	

LIFTING CAPACITIES AT ZERO DEGREE BOOM ANGLE ON RUBBER OPERATION																		
A	Stationary									Creep								
	Over Front						360° Rotation			Over Front								
	39.4'		68.1'		96.8'		39.4'		68.1'	96.8'		39.4'		68.1'	96.8'			
C	B	(12m)	B	(20.8m)	B	(29.5m)	B	(12m)	B	(20.8m)	B	(29.5m)	B	(12m)	B	(20.8m)	B	(29.5m)
0	32.2'	19,300	60.8'	6,300	89.1'	2,100	32.2'	5,100			32.2'	14,100	60.8'	5,000	89.1'	1,400		

- A** :Boom length in feet
- B** :Load radius in feet
- C** :Loaded boom angle (°)
- D** :Minimum boom angle (°) for indicated length (no load)

NOTE: The lifting capacity data stored in the LOAD MOMENT INDICATOR (AML-C) is based on the standard number of parts of line listed in the chart. Standard number of parts of line for rubber operation should be according to the following table.

Boom length in feet (meters)	39.4' (12m)	39.4' to 96.8' (12m to 29.5m)	Single top Jib
Number of parts of line	6	4	1

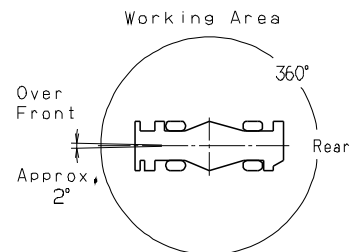

## WARNING AND OPERATING INSTRUCTIONS FOR ON RUBBER LIFTING CAPACITIES

1. Rated lifting capacities on rubber are in pounds and do not exceed 75 % of tipping loads as determined by SAE J765-Crane Stability Test Code.
2. Rated lifting capacities shown in the chart are based on condition that crane is set on firm level surfaces with axle oscillation lockout applied. Those above bold lines are based on tire capacity and those below, on crane stability. They are based on actual load radius increased by tire deformation and boom deflection.
3. If the axle oscillation lockout cylinders contain air, the axle will not be locked completely and rated lifting capacities may not be obtainable. Bleed the cylinders according to the operation safety and maintenance manual.
4. Rated lifting capacities are based on proper tire inflation, capacity and condition. Damaged tires are hazardous to safe operation of crane.
5. Tires shall be inflated to correct air pressure.
6. Over front operation shall be performed within two degrees in front of chassis.
7. On rubber lifting with "jib" is not permitted. Maximum permissible boom length is 96.8 ft. (29.5m).
8. When making lift on rubber stationary, set parking brake.
9. For creep operation, boom must be centered over front of machine, slewing lock engaged, and load restrained from slewing. Travel slowly and keep the lifted load as close to the ground as possible, and especially avoid any abrupt steering, accelerating or braking.
10. Do not operate the crane while carrying the load.
11. Creep is motion for crane not to travel more than 200' (60 m) in any 30 minute period and to travel at the speed of less than 1 mph (1.6km/h).
12. For creep operation, choose the drive mode and proper gear according to the road or working condition.

Tires	Air Pressure
29.5-25 34PR	57 psi (400kPa)

# WARNING AND OPERATING INSTRUCTIONS FOR USING THE LOAD MOMENT INDICATOR (AML-C)

1. When operating crane on outriggers:
    - Set P.T.O. switch to "ON".
    - Press the outrigger mode select key to register for the outrigger operation. Press the register key, then the outrigger mode indicative symbol changes from flashing to a solid light.
    - Press the lift mode select key to select the lift status that corresponds to the actual boom configuration. Each time the lift mode select key is pressed, the status changes. Press the register key to register the lift status, then the lift indicative symbol changes from flashing to a solid light.
    - when mounting and stowing jib, select the jib set status. (the jib state indicative symbol will be flashing.)
  2. When operating crane on rubber:
    - Set P.T.O. switch to "ON".
    - Press the outrigger mode select key. The on-tire mode indicative symbol comes on. Each time the outrigger mode select key is pressed the status changes. Select the creep operation, the on-tire mode indicative symbol flicker.
    - Press the lift mode select key to register the boom or single top lift.
- However, pay attention to the following.
- (1) For stationary operation.
    - The front capacities are attainable only when the over front position symbol comes on. When the boom is more than 2 degrees from centered over front of chassis, 360° capacities are in effect.
  - (2) For creep operation.
    - The creep capacities are attainable only when boom is in the straight forward position of chassis and the over front position symbol is on. If boom is not in the straight forward position of chassis, never lift load.
3. A slewing does not automatically stop even if the crane becomes overloaded.
  4. During crane operation, make sure that the displays on front panel are in accordance with actual operating conditions.
  5. The displayed values of LOAD MOMENT INDICATOR (AML-C) are based on freely suspended loads and make no allowance for such factors as the effect of wind, sudden stopping of loads, supporting surface conditions, inflation of tire, operating speed, side loads, etc.  
For safe operation, it is recommended when extending and lowering boom or slewing, lifting loads shall be appropriately reduced.
  6. LOAD MOMENT INDICATOR (AML-C) is intended as an aid to the operator. Under no condition should it be relied upon to replace use of capacity charts and operating instruction. Sole reliance upon LOAD MOMENT INDICATOR (AML-C) aids in place of good operating practice can cause an accident. The operator must exercise caution to assure safety.

## GR-1000XL Axle weight distribution chart

	Pounds			Kilograms			
	GVW	Front	Rear	GVW	Front	Rear	
Base machine	115,610	57,340	58,270	52,440	26,010	26,430	
Remove:	1. 7.3ton (6.6metric ton) hook ball	-360	-515	155	-165	-235	70
	2. 100ton (90.7metric ton) hook block	-1,900	-3,665	1,765	-862	-1,664	802
	3. Top jib	-740	-990	250	-336	-450	114
	4. Base jib	-1,910	-3,755	1,845	-867	-1,704	837
	5. Auxiliary lifting sheave	-110	-330	220	-50	-149	99
	6. Removable counterweight [self-removable] (with Auxiliary hoist & wire rope)	-22,000	9,350	-31,350	-9,979	4,240	-14,219

### TADANO AMERICA Corporation

4242 West Greens Road  
Houston, Texas, 77066 U.S.A.  
Phone: (281) 869-0030  
Fax: (281) 869-0040  
www.tadanoamerica.com

Form No. TAC-GR-1000-3-00311-08042015