

LTM 1250/1

Mobile Crane
Grue automotrice

Telescopic boom
Flèche télescopique

236 ft

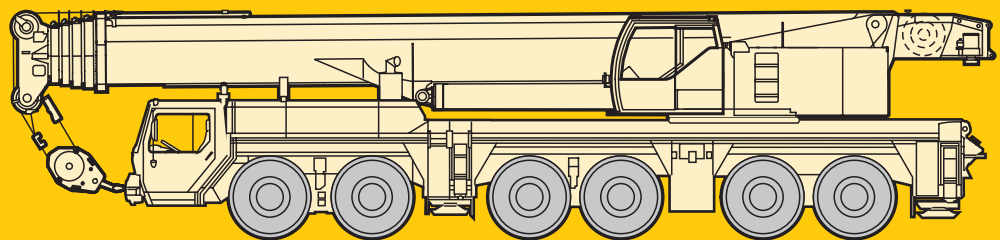

LIEBHERR

Lifting capacities on telescopic boom. Forces de levage à la flèche télescopique.

LTM 1250/1



51 ft – 236 ft



360°



214900 lbs

85%

ft	51 ft		68 ft	85 ft	102 ft	119 ft	136 ft	153 ft	170 ft	187 ft	204 ft	221 ft	236 ft	ft
	*													
9		389												9
10	585	388	297											10
12	370	370	297	258										12
14	331	331	297	258										14
16	305	305	284	258	197									16
18	286	286	267	250	197	157								18
21	261	261	246	232	197	157	134							21
24	239	239	226	214	195	157	134	104						24
27	220	220	209	198	188	157	134	104	81.5					27
30	201	201	195	184	175	157	132	102	81.5	63.5				30
33	183	183	182	172	164	156	130	97.5	81	63.5				33
36	163	163	170	162	154	150	129	93.5	79	63.5	46.3			36
39	142	142	158	153	145	141	124	89.5	76.5	63.5	46.3	41.3		39
45			137	136	130	127	113	82	71.5	60.5	46.3	41.1		45
51			115	121	117	115	104	74.5	66	57.4	46.3	40.8	34	51
57			76.5	107	105	104	96	68	60.5	53.6	46	39.8	33.8	57
63				93	94.5	95	89	63	55.7	49.9	44	38.5	33.2	63
69				79	84	86	82.5	59.2	51	46.4	41.3	36.9	32.3	69
75					75	77.5	76.5	56.1	46.9	43.2	38.8	35.1	31	75
81					65.5	72.5	71	53.2	43.7	40	36.4	33.2	29.4	81
87					59.1	67	65	50.5	40.9	37	34.2	31.4	27.9	87
93						61	59.4	48	38.4	34.5	32.1	29.8	26.4	93
99						53.8	54.3	45.6	36.1	32.1	30.1	28.2	25.1	99
105							49.9	44	33.8	30.3	28.3	26.6	23.7	105
111							45.9	42.4	32	28.6	26.5	25.1	22.5	111
117							40.7	40.9	30.7	27	24.9	23.8	21.3	117
123							36.2	39.5	29.5	25.4	23.6	22.4	20.1	123
129								36.9	28.4	24.1	22.4	21.1	19	129
135								33.6	27.4	22.9	21.2	19.8	17.9	135
141								23.1	26.3	21.8	20.1	18.6	16.9	141
147									25.4	20.8	19.3	17.4	15.9	147
153									24.4	19.8	18.4	16.3	14.9	153
159										19	17.7	15.4	14	159
165										18.3	16.9	14.6	13.3	165
171										17.7	16.2	13.7	12.6	171
177										14.7	15.5	12.9	11.9	177
183											14.8	12.2	11.2	183
189												11.4	10.5	189
195												10.7	9.8	195
201												10	9.2	201
207													8.5	207
213													7.9	213
I	0	0/ 0/ 0	46/ 0/ 0	92/46/ 0	46/ 0/ 0	46/ 0/ 0	92/46/46	92/46/46	92/46/46	92/46/46	92/46	92	100	I
II	0	46/ 0/ 0	46/46/ 0	46/46/ 0	46/46/ 0	46/92/46	46/92/46	92/92/46	92/92/46	92/92/46	92/92	92	100	II
III	0	0/46/ 0	0/46/ 0	0/46/46	46/46/92	46/46/46	46/46/46	46/92/46	92/92/92	92/92/92	92/92	92	100	III
IV	0	0/ 0/46	0/ 0/46	0/ 0/46	46/46/46	46/46/46	46/46/46	46/46/92	46/92/92	46/92/92	92/92	92	100	IV
% V	0	0/ 0/ 0	0/ 0/46	0/ 0/46	0/46/46	46/46/92	46/46/92	46/46/92	46/46/92	46/46/92	46/92	92	100	V

* over rear / en arrière

TAB 131201 / 131237

Lifting capacities are given in kips (1,000 lbs).

Lifting capacities on telescopic boom. Forces de levage à la flèche télescopique.

LTM 1250/1



51 ft – 236 ft

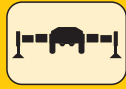

360°



187400 lbs



85%

ft	51 ft	68 ft	85 ft	102 ft	119 ft	136 ft	153 ft	170 ft	187 ft	204 ft	221 ft	236 ft	ft	
9	389												9	
10	388	297											10	
12	370	297	258										12	
14	331	297	258										14	
16	305	284	258	197									16	
18	286	267	250	197	157								18	
21	261	246	232	197	157	134							21	
24	239	226	214	195	157	134	104						24	
27	220	209	198	188	157	134	104	81.5					27	
30	201	195	184	175	157	132	102	81.5	63.5				30	
33	183	182	172	164	156	130	97.5	81	63.5				33	
36	163	170	162	154	150	129	93.5	79	63.5	46.3			36	
39	142	158	153	145	141	124	89.5	76.5	63.5	46.3	41.3		39	
45		137	136	130	127	113	82	71.5	60.5	46.3	41.1		45	
51		115	119	116	115	104	74.5	66	57.4	46.3	40.8	34	51	
57		76.5	103	102	103	96	68	60.5	53.6	46	39.8	33.8	57	
63			90.5	89	91.5	89	63	55.7	49.9	44	38.5	33.2	63	
69			78.5	78.5	83	82	59.2	51	46.4	41.3	36.9	32.3	69	
75				70	76.5	74.5	56.1	46.9	43.2	38.8	35.1	31	75	
81				64.5	69	67	53.2	43.7	40	36.4	33.2	29.4	81	
87				59.1	63	61	50.5	40.9	37	34.2	31.4	27.9	87	
93					57.3	55.2	48	38.4	34.5	32.1	29.8	26.4	93	
99					52.4	50.2	45.6	36.1	32.1	30.1	28.2	25.1	99	
105						45.8	44	33.8	30.3	28.3	26.6	23.7	105	
111							42.4	32	28.6	26.5	25.1	22.5	111	
117							38.6	40.3	30.7	27	24.9	23.8	117	
123							36.2	37.4	29.5	25.4	23.6	22.4	123	
129								34.6	28.4	24.1	22.4	21.1	129	
135								32.2	27.4	22.9	21.2	19.8	135	
141								22.6	26.3	21.8	20.1	18.6	141	
147									25.4	20.8	19.3	17.4	147	
153									19.8	19.8	18.4	16.3	153	
159										19	17.7	15.4	159	
165										18.3	16.9	14.6	165	
171										17.7	16.2	13.7	171	
177										14.7	15.5	12.9	177	
183											14.8	12.2	183	
189												11.4	189	
195												10.7	195	
201												10	201	
207													207	
213													213	
I	0	0/ 0/ 0	46/ 0/ 0	92/46/ 0	46/ 0/ 0	46/ 0/ 0	92/46/46	92/46/46	92/46/46	92/46/46	92/46	92	100	I
II	0	46/ 0/ 0	46/46/ 0	46/46/ 0	46/46/ 0	46/92/46	46/92/46	92/92/46	92/92/46	92/92/46	92/92	92	100	II
III	0	0/46/ 0	0/46/ 0	0/46/46	46/46/92	46/46/46	46/46/46	46/92/46	92/92/92	92/92/92	92/92	92	100	III
IV	0	0/ 0/46	0/ 0/46	0/ 0/46	46/46/46	46/46/46	46/46/46	46/46/92	46/92/92	46/92/92	92/92	92	100	IV
% V	0	0/ 0/ 0	0/ 0/46	0/ 0/46	0/46/46	46/46/92	46/46/92	46/46/92	46/46/92	46/46/92	46/92	92	100	V

TAB 131238

Lifting capacities on telescopic boom. Forces de levage à la flèche télescopique.

LTM 1250/1



51 ft – 236 ft

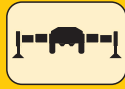

360°



37500 lbs

85%

ft	51 ft	68 ft	85 ft	102 ft	119 ft	136 ft	153 ft	170 ft	187 ft	204 ft	221 ft	236 ft	ft	
9	389												9	
10	388	297											10	
12	370	297	258										12	
14	331	297	258										14	
16	305	284	258	197									16	
18	277	256	234	192	157								18	
21	231	212	191	171	149	133							21	
24	185	169	153	139	131	126	103						24	
27	149	142	131	128	117	107	99	80.5					27	
30	123	121	116	109	101	94.5	89.5	79.5	63.5				30	
33	104	104	100	94.5	87.5	86	78.5	72	63				33	
36	89.5	90	87.5	83	78	76	71.5	67.5	62	46.3			36	
39	78	79	77.5	74.5	69	68	65.5	61	56.4	46.3	41.3		39	
45		63	62	62	55.8	57.4	54.3	51.7	48.1	44.4	40.6	33.9	45	
51		50.8	51	51.6	49.3	48.6	45.9	43.8	40.4	37.8	34.2	32	51	
57		41	42.5	43.4	42.1	41	38.8	36.8	33.7	31.4	28.1	27.3	57	
63			35.8	36.7	35.7	34.8	32.9	31.1	28.3	26.2	23.2	22.5	63	
69			29.8	31.3	30.4	29.8	28	26.4	23.8	21.9	19.1	18.6	69	
75				26.9	26.1	25.6	24	22.5	20.1	18.4	15.7	15.3	75	
81				23.1	22.5	22.1	20.6	19.3	17	15.3	12.8	12.4	81	
87				19.6	19.5	19.2	17.7	16.5	14.3	12.8	10.3	10	87	
93					16.8	16.7	15.2	14.1	12	10.5	8.1	7.8	93	
99					14.3	14.5	13.1	12	9.9	8.5			99	
105						12.5	11.2	10.2	8.2				105	
111							10.6	9.6	8.6	6.6			111	
117							9	8.1	7.1	5.2			117	
123							7.6	6.7	5.9				123	
129								5.3	4.8				129	
135								4.2					135	
I	0	0/ 0/ 0	46/ 0/ 0	0/ 0/ 0	0/ 0/ 0	0/ 0/ 0	46/ 0/ 0	46/46/ 0	92/46/ 0	92/46	92	100	I	
II	0	46/ 0/ 0	46/46/ 0	0/ 0/ 0	46/ 0/ 0	46/ 0/ 0	46/46/ 0	92/46/46	92/92/92	92/92	92	100	II	
III	0	0/46/ 0	0/46/ 0	46/ 0/ 0	46/92/ 0	46/92/46	46/46/92	92/46/92	92/92/92	92/92	92	100	III	
IV	0	0/ 0/46	0/ 0/46	46/92/46	46/46/92	46/92/92	46/92/92	46/92/92	46/92/92	46/92/92	92/92	92	100	IV
%	0	0/ 0/ 0	0/ 0/46	46/46/92	46/46/92	92/46/92	92/92/92	46/92/92	46/46/92	46/92	92	100	V	

TAB 131244

Les forces de levage sont données en kips (1,000 lbs).

Lifting heights. Hauteurs de levage.

LTM 1250/1

Telescopic boom.
Flèche télescopique.

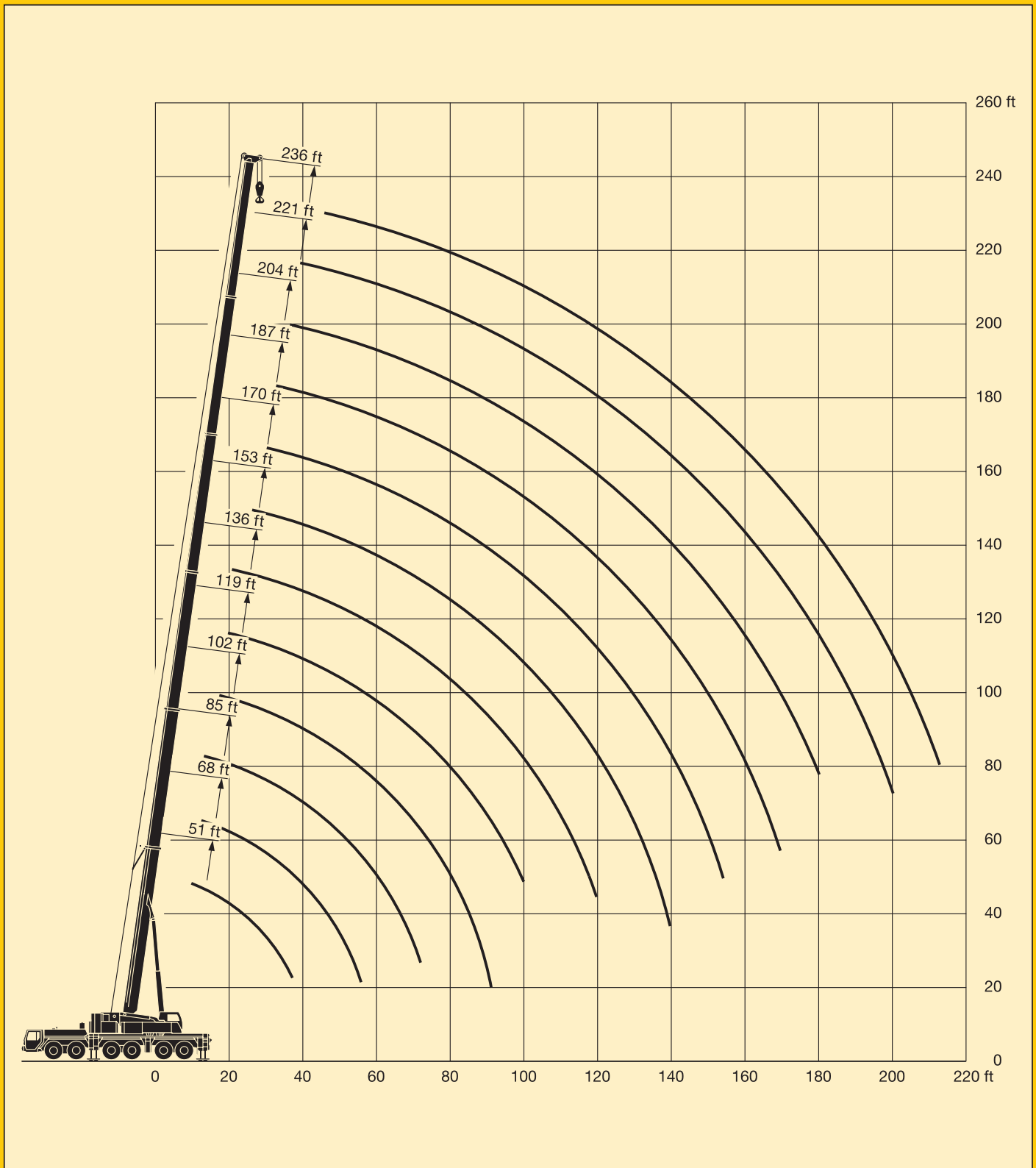

Lifting capacities on the folding jib. Forces de levage à la fléchette pliante.

LTM 1250/1



51 ft – 236 ft

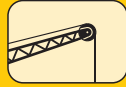

40 ft*

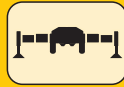

360°

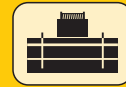

187400 lbs

85%

ft	51 ft			170 ft			187 ft			204 ft			221 ft			236 ft			ft
	0°	20°	40°	0°	20°	40°	0°	20°	40°	0°	20°	40°	0°	20°	40°	0°	20°	40°	
11	40																		11
12	39.8																		12
13	39.4																		13
14	39.1																		14
15	38.8																		15
16	38.5																		16
17	38.2																		17
18	37.9	32.7																	18
20	37.3	32.6																	20
22	36.6	32																	22
24	36	31.2																	24
26	35.3	30.1																	26
28	34.7	29.2	22.8																28
30	33.9	28.3	22.8																30
32	32.6	27.5	22.8	40															32
34	31.2	26.8	22.6	40															34
36	29.9	26.1	22.2	40			34.9												36
38	28.6	25.5	21.8	39.7			34.9												38
40	27.4	24.9	21.5	39.5			34.9												40
45	24.5	23.5	20.8	38.9	32.3		34.9			29.1			23.3						45
50	22.1	22.5	20.2	38.3	31.4		34.6	30.6		29.1			23.3			19.6			50
55	20	21.3	19.8	37.6	30.3	22.8	34.2	30.1	22.6	29.1	27.9		23.3			19.6			55
60	18	19.8	19.6	36.8	29.2	22.7	33.8	29.2	22.5	28.9	27.8		23.3			19.6			60
65	16.3	17.8	18.9	36.2	28.2	22.3	33.5	28.3	22.2	28.7	27.4	21.6	23.3	23.3		19.6	19.6		65
70	14.9	16.1	17	35.5	27.5	21.9	32.9	27.5	21.8	28.5	26.7	21.4	23.3	23.3		19.6	19.6		70
75	13.7	14.5	16.1	34.8	26.8	21.6	32.4	26.8	21.5	28.2	26.1	21.1	23.2	23	20.2	19.6	19.6		75
80				33.9	26.1	21.3	31.7	26.1	21.2	27.9	25.5	20.8	22.9	22.5	20.2	19.6	19.6		80
85				32.6	25.4	21	30.6	25.5	20.9	26.9	24.9	20.6	22.2	22.1	20	19.3	19.4	19.2	85
90				31.1	24.8	20.8	29.2	24.9	20.7	25.8	24.4	20.3	21.6	21.5	19.8	18.7	18.9	19	90
95				29.7	24.2	20.5	27.8	24.4	20.5	24.6	23.9	20.2	21	20.8	19.6	18.2	18.3	18.6	95
100				28.3	23.6	20.3	26.5	23.9	20.2	23.6	23.4	20	20.4	20.2	19.4	17.7	17.8	18.1	100
105				27	23.2	20.1	25.2	23.4	20	22.5	22.9	19.8	19.8	19.6	19.3	17.1	17.3	17.7	105
110				25.8	22.8	19.9	24	22.9	19.9	21.6	22.1	19.7	19.2	18.9	18.9	16.6	16.9	17.2	110
115				24.6	22.3	19.8	22.9	22.5	19.7	20.6	21.3	19.6	18.6	18.3	18.4	16.1	16.4	16.7	115
120				23.4	22	19.6	21.8	21.9	19.6	19.7	20.3	19.4	17.9	17.8	17.8	15.7	16	16.2	120
125				22.4	21.6	19.5	20.7	21.2	19.4	18.8	19.4	19.2	17.2	17.2	17.3	15.2	15.5	15.7	125
130				21.5	21.2	19.4	19.5	20.1	19.2	17.9	18.5	18.9	16.5	16.7	16.7	14.5	14.9	15.2	130
135				20.6	20.5	19.3	18.4	19.1	19.1	17.1	17.6	18.1	15.8	16.1	16.2	13.9	14.4	14.7	135
140				19.7	19.6	19.1	17.4	18.1	18.6	16.3	16.8	17.3	15.1	15.6	15.7	13.3	13.8	14.2	140
145				18.8	18.8	18.9	16.6	17.1	17.7	15.5	15.9	16.5	14.4	15	15.2	12.7	13.2	13.7	145
150				18	18.1	18.2	15.9	16.1	16.8	14.7	15.1	15.7	13.8	14.3	14.8	12.1	12.6	13.1	150
155				17.2	17.3	17.5	15.4	15.4	15.9	13.9	14.4	14.9	13.2	13.7	14.2	11.5	12	12.5	155
160				16.5	16.6	16.8	14.8	14.7	15	13.3	13.6	14.1	12.6	13.1	13.5	11	11.4	11.9	160
165				15.9	15.9	16.2	14.2	14.1	14.3	12.8	13	13.4	12	12.5	12.8	10.4	10.9	11.4	165
170				15.3	15.3	15.5	13.7	13.5	13.7	12.3	12.5	12.7	11.5	11.9	12.2	9.9	10.3	10.8	170
175				14.8	14.8	14.9	13.2	12.9	13.1	11.9	12	12.1	10.9	11.3	11.6	9.4	9.8	10.2	175
180				14.2	14.3	14.3	12.7	12.4	12.6	11.4	11.5	11.6	10.3	10.7	11	8.9	9.4	9.7	180
185				13.7	13.8		12.2	11.9	12.1	11	11.1	11.1	9.7	10.1	10.4	8.5	8.9	9.2	185
190				13.2	13.3		11.7	11.5	11.5	10.5	10.7	10.7	9.2	9.6	9.9	8.1	8.5	8.8	190
195				9.7			11.2	11	11.1	10.1	10.3	10.3	8.6	9.1	9.3	7.7	8	8.3	195
200							10.8	10.6		9.7	9.9	9.8	8.2	8.7	8.8	7.3	7.6	7.9	200
205							10.3	10.2		9.3	9.5	9.4	7.8	8.2	8.2	7	7.1	7.5	205
210										9	9.1	9	7.3	7.8	7.7	6.6	6.7	7.1	210
215										8.6	8.7	8.6	7	7.3	7.2	6.3	6.4	6.7	215
220										8.2	8.3		6.6	6.9	6.7	6	6	6.2	220
225													6.2	6.5	6.3	5.6	5.6	5.8	225
230													5.8	6.1		5.2	5.3	5.4	230
235													5.5	5.7		4.9	4.9	5	235
240													5.1	5.3		4.5	4.6	4.6	240
245																4.1	4.3		245
250																3.8	3.9		250
255																3.4	3.5		255

TAB 131246.1/6 / 131254.1/6 / 131262.1/6

Lifting capacities on the folding jib. Forces de levage à la fléchette pliante.

LTM 1250/1



51 ft – 236 ft

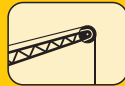

72 ft*



360°

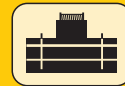

187400 lbs

85%

ft	51 ft			170 ft			187 ft			204 ft			221 ft			236 ft			ft
	0°	20°	40°	0°	20°	40°	0°	20°	40°	0°	20°	40°	0°	20°	40°	0°	20°	40°	
13 - 20	17																		13 - 20
22	17																		22
24	17																		24
26	16.9																		26
28	16.8																		28
30	16.6																		30
32	16.4																		32
34	16.2																		34
36	16	14.6		17															36
38	15.9	14.6		17			16												38
40	15.7	14.5		17			16												40
45	15.1	14		17			16			14.3									45
50	14.6	13.4		17			16			14.3			13.1						50
55	14	12.9	11.4	17			16			14.3			13.1			11.6			55
60	13.5	12.4	11.3	16.9			16			14.3			13.1			11.6			60
65	13	12	10.9	16.8	14.6		15.9			14.3			13			11.6			65
70	12.5	11.6	10.5	16.5	14.4		15.7	14		14.3			12.9			11.6			70
75	12.2	11.2	10.2	16.3	14.1		15.5	13.8		14.2	12.9		12.9			11.6			75
80	11.9	10.9	9.9	16	13.8		15.3	13.5		14.1	12.8		12.8			11.6			80
85	11.6	10.7	9.7	15.8	13.6	11.4	15.1	13.3	11.2	14	12.7		12.6	11.9		11.6			85
90	11.2	10.4	9.5	15.6	13.3	11.3	14.9	13	11.1	13.9	12.5	10.7	12.6	11.8		11.5	10.9		90
95	10.8	10.1	9.4	15.3	13	11.1	14.7	12.8	11	13.7	12.3	10.7	12.5	11.6	10.2	11.4	10.9		95
100	10.3	9.9	9.3	15	12.8	10.9	14.5	12.6	10.9	13.6	12.1	10.6	12.4	11.4	10.2	11.3	10.8	9.7	100
105	9.6	9.7		14.7	12.5	10.7	14.3	12.4	10.7	13.4	11.9	10.5	12.3	11.3	10.1	11.2	10.7	9.7	105
110	9	9.4		14.4	12.3	10.5	14.1	12.1	10.6	13.3	11.7	10.3	12.2	11.1	10	11.2	10.6	9.7	110
115				14.2	12.1	10.4	13.8	12	10.4	13.1	11.6	10.2	12.1	11	9.9	11.1	10.5	9.6	115
120				13.9	11.9	10.2	13.6	11.8	10.2	12.9	11.4	10.2	12	10.9	9.8	11.1	10.4	9.4	120
125				13.6	11.7	10	13.4	11.6	10.1	12.8	11.2	10	11.9	10.7	9.7	11	10.3	9.3	125
130				13.3	11.5	9.9	13.2	11.4	10	12.6	11.1	9.9	11.8	10.6	9.5	10.9	10.2	9.2	130
135				13.1	11.4	9.8	12.9	11.3	9.9	12.4	11	9.8	11.7	10.5	9.4	10.9	10.1	9.1	135
140				12.8	11.2	9.7	12.7	11.1	9.8	12.3	10.8	9.6	11.6	10.4	9.4	10.8	10	9	140
145				12.6	11.1	9.7	12.5	11	9.7	12.1	10.7	9.5	11.4	10.3	9.3	10.7	10	9	145
150				12.4	10.9	9.6	12.3	10.9	9.6	11.9	10.7	9.5	11.3	10.2	9.2	10.4	9.9	8.9	150
155				12.2	10.8	9.5	12.2	10.8	9.6	11.8	10.6	9.4	11.2	10.2	9.1	10	9.8	8.8	155
160				12.1	10.7	9.5	12	10.7	9.5	11.6	10.5	9.4	11	10.1	9	9.6	9.7	8.8	160
165				11.9	10.6	9.4	11.8	10.7	9.5	11.4	10.4	9.3	10.7	10	9	9.1	9.6	8.7	165
170				11.8	10.5	9.3	11.6	10.6	9.4	11.1	10.4	9.2	10.2	9.9	9	8.8	9.5	8.7	170
175				11.6	10.3	9.3	11.4	10.5	9.4	10.6	10.3	9.2	9.8	9.8	9	8.4	9.2	8.6	175
180				11.5	10.2	9.3	11	10.3	9.4	10.1	10.1	9.2	9.4	9.7	9	8	8.8	8.6	180
185				11.3	10.1	9.3	10.6	10.2	9.3	9.7	10	9.2	9	9.5	9	7.6	8.4	8.6	185
190				11.1	10	9.3	10.2	10	9.3	9.2	9.8	9.2	8.6	9.3	9	7.3	8	8.6	190
195				10.8	9.8	9.3	9.8	9.9	9.3	8.8	9.4	9.2	8.2	8.9	9	6.9	7.6	8.3	195
200				10.6	9.7	9.3	9.5	9.6	9.3	8.4	8.9	9	7.8	8.5	8.8	6.6	7.2	7.9	200
205				10.3	9.7	9.3	9.1	9.3	9.2	8.1	8.5	8.7	7.4	8.1	8.5	6.3	6.9	7.5	205
210				10	9.7	9.3	8.8	8.9	9.1	7.7	8.1	8.4	7	7.7	8.1	6	6.5	7.1	210
215				9.7	9.6	9.3	8.4	8.6	8.7	7.5	7.8	8.1	6.7	7.2	7.6	5.7	6.2	6.7	215
220				9.3	9.4		8.1	8.2	8.3	7.2	7.4	7.7	6.3	6.8	7.2	5.4	5.9	6.4	220
225							7.8	7.9	7.9	6.9	7.1	7.4	6	6.4	6.7	5.1	5.6	6	225
230							7.5	7.5		6.7	6.8	7	5.7	6.1	6.3	4.9	5.3	5.6	230
235							7.2	7.2		6.4	6.6	6.7	5.4	5.7	5.9	4.5	5	5.3	235
240							6.9			6.2	6.3	6.3	5.1	5.4	5.5	4.2	4.7	5	240
245										6	6.1		4.9	5.1	5.2	3.9	4.4	4.6	245
250										5.7	5.8		4.6	4.8	4.8	3.6	4.1	4.3	250
255										5.5	5.6		4.3	4.4	4.4	3.3	3.7	3.9	255
260													4	4.2	4.1	3	3.4	3.5	260
265													3.7	3.8		2.7	3	3.1	265
270													3.4	3.5		2.4	2.7	2.7	270
275													3.1	3.2		2.2	2.4	2.3	275
I	0			46/ 0			92/46/ 0			92/46			92			100			I
II	0			92/46			92/92/92			92/92			92			100			II
III	0			92/92			92/92/92			92/92			92			100			III
IV	0			46/92			46/92/92			92/92			92			100			IV
% V	0			46/92			46/46/92			46/92			92			100			V

* bi-parted folding jib / fléchette pliante à 2 éléments

TAB 131246.3/6 / 131254.3/6 / 131262.3/6

Lifting heights. Hauteurs de levage.

LTM 1250/1

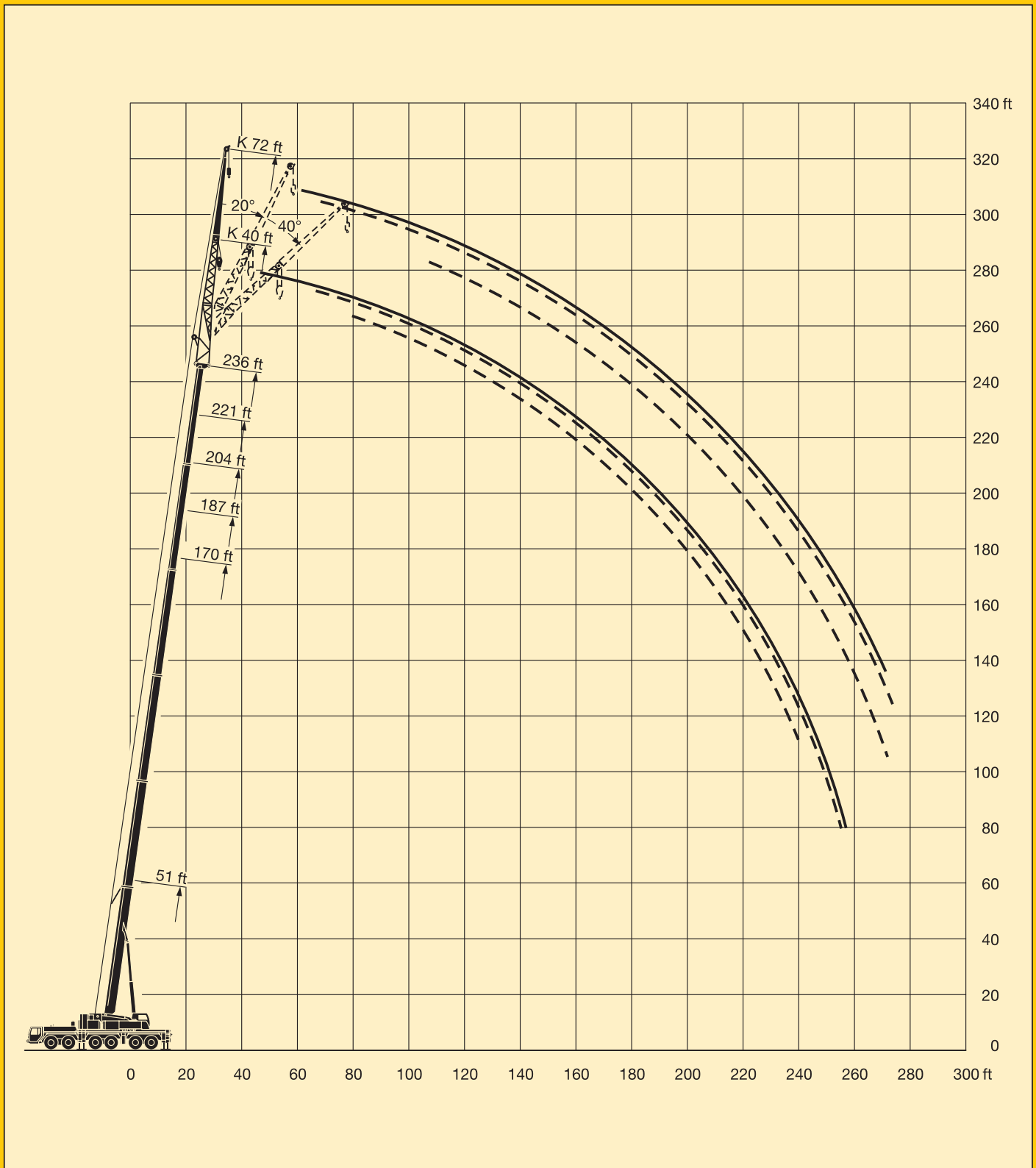

Lifting capacities on the folding jib. Forces de levage à la fléchette pliante.

LTM 1250/1



51 ft - 236 ft

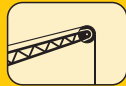

63 ft*



360°

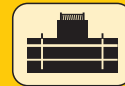

187400 lbs

85%

ft	51 ft			170 ft			187 ft			204 ft			221 ft			236 ft			ft
	0°	20°	40°	0°	20°	40°	0°	20°	40°	0°	20°	40°	0°	20°	40°	0°	20°	40°	
13 - 28	23.4																		13 - 28
30	23.3																		30
32	22.8	21.3																	32
34	22.4	21.1																	34
36	21.9	20.7		23.4															36
38	21.5	20.2		23.4			23												38
40	21.1	19.7		23.4			23												40
45	20.1	18.6		23.4			22.9			19.4									45
50	19.1	17.5	14.1	23.4			22.7			19.4			16.5						50
55	18.1	16.5	13.7	23.4	21.2		22.5			19.3			16.5			14.3			55
60	17.1	15.6	13.1	23.4	21.1		22.1			19.2			16.5			14.3			60
65	16.1	14.7	12.6	23.4	20.5		21.8	19.4		19			16.5			14.3			65
70	15.3	14	12.1	23.2	19.9		21.5	19.1		18.8	17.5		16.4			14.3			70
75	14.4	13.4	11.8	22.8	19.4	14.1	21.3	18.7	14.1	18.6	17.3		16.3	15.3		14.3			75
80	13.5	12.8	11.6	22.2	18.8	14	20.9	18.3	14	18.4	17.1		16.2	15.3		14.3			80
85	12.5	12.4	11.4	21.7	18.3	13.8	20.5	17.8	13.8	18.3	16.7	13.3	16	15.1		14.2	13.9		85
90	11.6	12	11.3	21.2	17.8	13.5	20.1	17.3	13.5	18.1	16.4	13.2	15.9	14.9	12.6	14.1	13.7		90
95	10.8	11.4	11.2	20.7	17.3	13.2	19.7	16.9	13.3	17.8	16	13.1	15.8	14.7	12.5	14	13.6	11.6	95
100	10			20.2	16.8	13	19.3	16.5	13	17.5	15.7	12.9	15.6	14.4	12.3	13.9	13.4	11.6	100
105				19.8	16.3	12.7	18.9	16.1	12.8	17.2	15.3	12.7	15.5	14.2	12.2	13.8	13.2	11.6	105
110				19.3	15.9	12.6	18.6	15.7	12.6	17	15	12.5	15.3	13.9	12	13.7	13	11.5	110
115				18.8	15.5	12.4	18.2	15.3	12.4	16.7	14.7	12.3	15.1	13.7	11.8	13.5	12.8	11.4	115
120				18.3	15.1	12.2	17.8	15	12.3	16.5	14.4	12.1	14.9	13.5	11.6	13.2	12.6	11.2	120
125				17.8	14.8	12	17.4	14.6	12.1	16.3	14.1	11.9	14.8	13.2	11.5	12.8	12.4	11.1	125
130				17.3	14.4	11.9	17	14.3	12	15.9	13.8	11.8	14.4	13	11.4	12.4	12.3	11	130
135				16.8	14.1	11.8	16.5	14	11.8	15.5	13.5	11.6	14	12.8	11.2	12	12.1	10.9	135
140				16.4	13.8	11.7	16.1	13.8	11.7	14.9	13.3	11.5	13.5	12.6	11.1	11.5	11.9	10.8	140
145				15.9	13.5	11.6	15.7	13.6	11.6	14.2	13.1	11.4	12.9	12.4	11.1	11.1	11.7	10.7	145
150				15.5	13.2	11.5	15.1	13.3	11.5	13.6	12.9	11.3	12.4	12.3	11	10.7	11.3	10.6	150
155				15.1	13	11.4	14.3	13.1	11.5	13	12.7	11.2	11.9	12.1	10.9	10.2	10.9	10.5	155
160				14.7	12.8	11.4	13.6	12.9	11.4	12.5	12.5	11.2	11.4	11.8	10.8	9.8	10.6	10.4	160
165				14.3	12.6	11.3	12.9	12.7	11.4	11.9	12.3	11.1	10.9	11.4	10.7	9.4	10.2	10.3	165
170				13.8	12.4	11.3	12.2	12.5	11.3	11.3	11.9	11.1	10.4	11.1	10.6	9	9.7	10.2	170
175				13.3	12.2	11.2	11.7	12.1	11.3	10.7	11.4	11	10	10.7	10.5	8.6	9.3	9.9	175
180				12.8	12.1	11.2	11.1	11.6	11.2	10.2	10.8	10.9	9.5	10.2	10.5	8.2	8.8	9.5	180
185				12.4	11.9	11.2	10.7	11	11.1	9.7	10.3	10.7	9.1	9.8	10.3	7.8	8.4	9	185
190				11.9	11.7	11.2	10.3	10.5	10.8	9.3	9.7	10.2	8.7	9.2	9.8	7.4	8	8.5	190
195				11.5	11.5	11.2	9.9	10.1	10.3	9	9.2	9.6	8.2	8.8	9.2	7	7.6	8.1	195
200				11.1	11.1	11.1	9.5	9.7	9.9	8.7	8.8	9.1	7.8	8.3	8.7	6.7	7.2	7.7	200
205				10.7	10.7		9.1	9.2	9.5	8.3	8.4	8.7	7.4	7.9	8.3	6.3	6.9	7.2	205
210				10.3	10.3		8.8	8.9	9	8	8.1	8.3	6.9	7.5	7.8	6	6.5	6.9	210
215				9.9	9.9		8.4	8.5	8.6	7.7	7.7	8	6.5	7	7.3	5.7	6.2	6.5	215
220							8.1	8.2	8.2	7.4	7.4	7.6	6.1	6.6	6.9	5.3	5.8	6.1	220
225							7.7	7.8		7.1	7.1	7.3	5.8	6.2	6.4	5	5.5	5.8	225
230										6.8	6.8	6.9	5.5	5.8	6	4.7	5.1	5.4	230
235										6.6	6.5	6.6	5.2	5.4	5.6	4.4	4.9	5	235
240										6.3	6.2		4.9	5.1	5.2	4.1	4.5	4.7	240
245										6	6		4.6	4.8	4.9	3.8	4.1	4.3	245
250													4.3	4.5		3.5	3.8	3.9	250
255													4	4.2		3.2	3.4	3.5	255
260													3.7	3.9		2.9	3.1	3.1	260
265																2.6	2.7		265
I	0			46/0	0		92/46/0	0		92/46			92			100			I
II	0			92/46			92/92/92			92/92			92			100			II
III	0			92/92			92/92/92			92/92			92			100			III
IV	0			46/92			46/92/92			92/92			92			100			IV
V	0			46/92			46/46/92			46/92			92			100			V

* bi-parted folding jib / fléchette pliante à 2 éléments

TAB 131246.2/6 / 131254.2/6 / 131262.2/6

Lifting capacities on the folding jib. Forces de levage à la fléchette pliante.

LTM 1250/1



51 ft - 236 ft

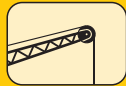

95 ft*



360°

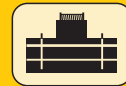

187400 lbs

85%

ft	51 ft			170 ft			187 ft			204 ft			221 ft			236 ft			ft
	0°	20°	40°	0°	20°	40°	0°	20°	40°	0°	20°	40°	0°	20°	40°	0°	20°	40°	
16 - 30	12.9																		16 - 30
32	12.8																		32
34	12.7																		34
36	12.6																		36
38	12.4				12.9														38
40	12.1				12.9														40
45	11.5				12.9			11.6											45
50	11	9.9			12.9			11.6			10.2								50
55	10.5	9.7			12.8			11.6			10.2		9						55
60	10	9.2			12.8			11.6			10.2		9						60
65	9.6	8.7			12.8			11.6			10.2		9						65
70	9.2	8.3	7		12.7			11.6			10.2		9			7.8			70
75	8.8	7.9	6.9		12.5	10		11.6			10.2		9			7.8			75
80	8.5	7.6	6.7		12.2	9.9		11.6			10.2		9			7.8			80
85	8.1	7.3	6.5		11.8	9.6		11.5	9.2		10.2	8.5	9			7.8			85
90	7.8	7	6.2		11.5	9.3		11.2	9.1		10.2	8.5	9	7.8		7.8			90
95	7.6	6.8	6		11.2	9.1	7	10.9	8.9		10.1	8.4	9	7.8		7.8	7		95
100	7.3	6.6	5.9		10.9	8.8	7	10.6	8.7	6.8	9.9	8.2	9	7.7		7.8	7		100
105	7	6.3	5.8		10.6	8.6	6.9	10.4	8.4	6.8	9.7	8.1	8.9	7.5		7.8	7		105
110	6.8	6.1	5.7		10.4	8.4	6.8	10.2	8.3	6.7	9.5	7.9	6.3	8.7	7.4		7.8	7	110
115	6.6	6	5.6		10.1	8.2	6.6	9.9	8.1	6.6	9.3	7.7	6.3	8.6	7.3	5.8	7.8	6.9	115
120	6.4	5.8	5.6		9.9	8	6.5	9.7	7.9	6.5	9.1	7.5	6.3	8.4	7.1	5.8	7.7	6.8	120
125	6.2	5.7	5.5		9.6	7.8	6.4	9.4	7.7	6.4	8.9	7.4	6.3	8.2	7	5.8	7.7	6.6	125
130	6	5.7	5		9.4	7.6	6.3	9.2	7.5	6.3	8.8	7.3	6.2	8.1	6.9	5.8	7.6	6.5	130
135					9.2	7.5	6.2	9	7.4	6.2	8.6	7.1	6.1	7.9	6.8	5.8	7.4	6.4	135
140					9	7.3	6.1	8.8	7.2	6.1	8.4	7	6	7.8	6.7	5.8	7.3	6.3	140
145					8.8	7.1	6	8.6	7.1	6	8.2	6.8	6	7.7	6.5	5.8	7.2	6.3	145
150					8.6	7	5.9	8.5	6.9	6	8.1	6.7	5.9	7.5	6.4	5.8	7.1	6.2	150
155					8.4	6.9	5.9	8.3	6.8	5.9	7.9	6.6	5.9	7.4	6.3	5.7	7	6.1	155
160					8.2	6.8	5.8	8.1	6.7	5.8	7.7	6.6	5.8	7.3	6.3	5.7	6.9	6	160
165					8	6.7	5.8	7.9	6.6	5.7	7.6	6.5	5.7	7.2	6.2	5.6	6.8	6	165
170					7.9	6.6	5.7	7.8	6.6	5.7	7.4	6.4	5.7	7.1	6.1	5.6	6.7	5.9	170
175					7.7	6.5	5.7	7.6	6.5	5.6	7.3	6.4	5.6	7	6.1	5.5	6.6	5.8	175
180					7.6	6.4	5.6	7.5	6.4	5.6	7.2	6.3	5.6	6.9	6	5.5	6.5	5.8	180
185					7.4	6.2	5.6	7.3	6.3	5.5	7.1	6.2	5.5	6.8	6	5.4	6.4	5.8	185
190					7.3	6.1	5.6	7.2	6.3	5.5	7	6.1	5.5	6.7	6	5.4	6.3	5.7	190
195					7.1	6.1	5.6	7.1	6.2	5.4	6.9	6.1	5.4	6.6	5.9	5.4	6.1	5.7	195
200					7	6	5.6	7	6.1	5.4	6.8	6.1	5.4	6.6	5.9	5.4	5.8	5.6	200
205					6.8	5.9	5.6	6.9	6.1	5.4	6.8	6	5.4	6.5	5.9	5.4	5.5	5.6	205
210					6.7	5.8	5.6	6.8	6	5.4	6.7	6	5.4	6.4	5.8	5.4	5.3	5.5	210
215					6.6	5.8	5.6	6.7	5.9	5.4	6.5	5.9	5.4	6.1	5.8	5.4	5	5.5	215
220					6.5	5.8	5.6	6.6	5.9	5.4	6.3	5.9	5.4	5.8	5.8	5.4	4.7	5.4	220
225					6.4	5.7	5.6	6.5	5.8	5.4	6.1	5.8	5.4	5.6	5.8	5.4	4.4	5.3	225
230					6.3	5.7	5.6	6.4	5.8	5.4	5.9	5.8	5.4	5.3	5.7	5.4	4.2	5	230
235					6.2	5.7	5.6	6.2	5.7	5.4	5.7	5.7	5.4	5	5.6	5.4	3.9	4.7	235
240					6.1	5.7		6	5.6	5.4	5.5	5.4	5.4	4.7	5.3	5.4	3.6	4.4	240
245					6			5.8	5.6	5.4	5.3	5.3	5.4	4.4	5	5.3	3.4	4.1	245
250								5.6	5.5		5.1	5.1	5.4	4.1	4.7	5	3.1	3.8	250
255								5.4	5.4		4.9	4.9	5.1	3.7	4.4	4.6	2.9	3.5	255
260								5.2	5.3		4.7	4.8	4.8	3.5	4.1	4.3	2.6	3.2	260
265											4.5	4.6	4.4	3.2	3.7	3.9		2.9	265
270											4.3	4.4		2.9	3.4	3.5		2.6	270
275											4.2	4.2		2.7	3.1	3.1		2.3	275
280											4			2.4	2.8	2.7		2.5	280
285															2.4				285
I	0				46/ 0			92/46/ 0			92/46			92			100		I
II	0				92/46			92/92/92			92/92			92			100		II
III	0				92/92			92/92/92			92/92			92			100		III
IV	0				46/92			46/92/92			92/92			92			100		IV
V	0				46/92			46/46/92			46/92			92			100		V

* three-parted folding jib / fléchette pliante à 3 éléments

TAB 131246.5/6 / 131254.5/6 / 131262.5/6

Lifting heights. Hauteurs de levage.

LTM 1250/1

Folding jib.
Fléchette pliante.

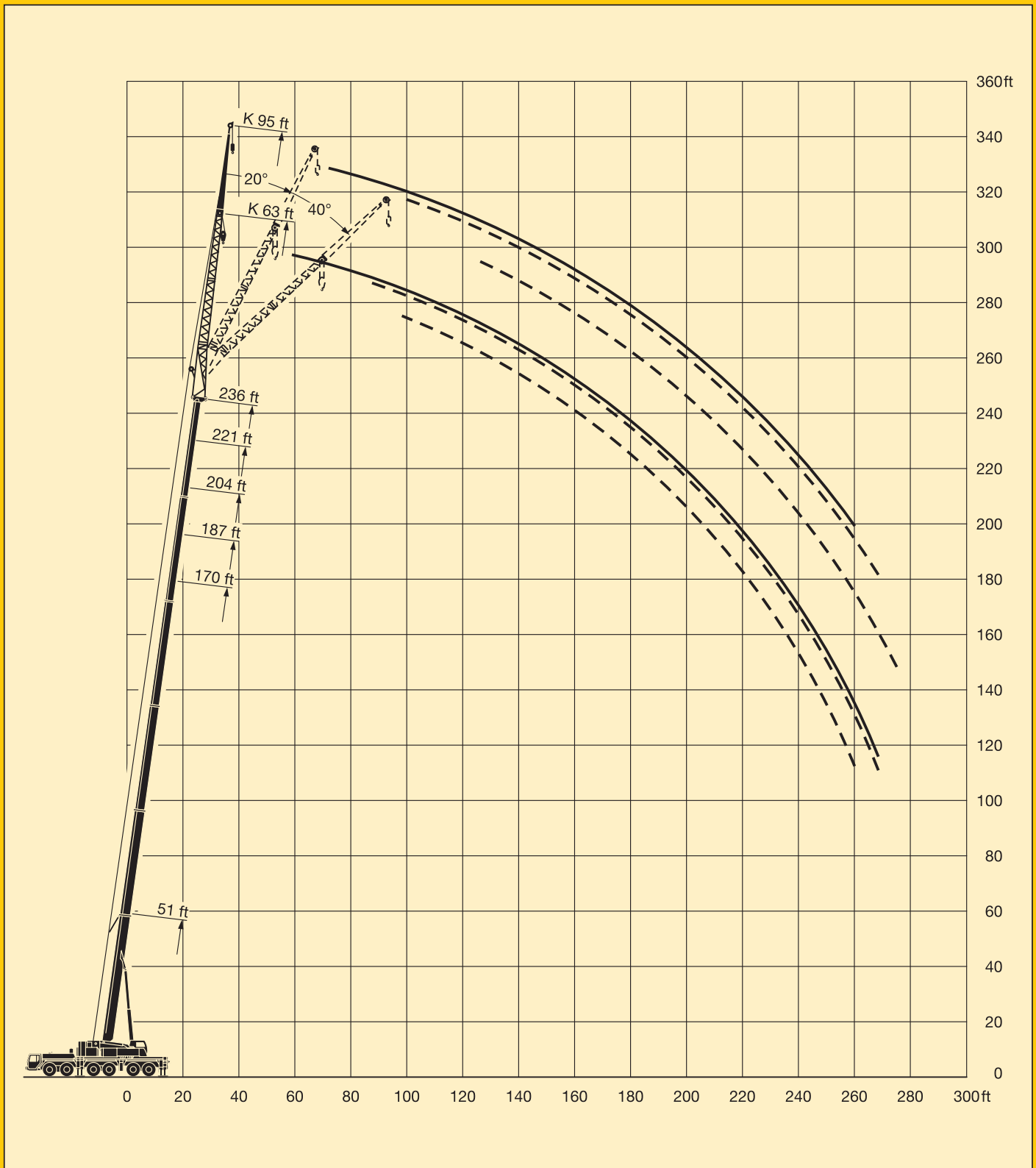

Lifting capacities on the folding jib. Forces de levage à la fléchette pliante.

LTM 1250/1



51 ft - 236 ft

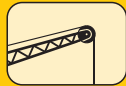

86 ft*



360°

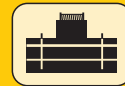

187400 lbs

85%

ft	51 ft			170 ft			187 ft			204 ft			221 ft			236 ft			ft
	0°	20°	40°	0°	20°	40°	0°	20°	40°	0°	20°	40°	0°	20°	40°	0°	20°	40°	
14 - 26	16.5																		14 - 26
28	16.5																		28
30	16.4																		30
32	16.3																		32
34	16																		34
36	15.7																		36
38	15.4				16.5														38
40	15				16.5														40
45	14.1	12.4			16.5			15											45
50	13.4	11.9			16.5			15			13.1								50
55	12.6	11.2			16.5			15			13.1			10.9				9.7	55
60	11.9	10.6			16.5			15			13.1			10.9				9.7	60
65	11.3	10.1	8.3		16.4			15			13.1			10.9				9.7	65
70	10.7	9.6	8.1		16.2	12.4		14.9			13.1			10.9				9.7	70
75	10.2	9.1	7.8		15.8	12.2		14.7	11.4		13			10.9				9.7	75
80	9.8	8.7	7.5		15.2	11.8		14.5	11.3		12.9			10.9				9.7	80
85	9.3	8.3	7.1		14.8	11.4		14.1	11.1		12.8	10.4		10.9				9.7	85
90	8.9	8	6.9		14.3	11.1	8.3	13.7	10.8		12.6	10.2		10.9	9.2			9.7	90
95	8.6	7.7	6.7		13.9	10.8	8.2	13.4	10.6	8	12.3	10		10.9	9.2			9.7	95
100	8.2	7.4	6.5		13.5	10.5	8.1	13	10.3	8	12	9.8	7.8	10.8	9.1			9.6	100
105	8	7.1	6.4		13.1	10.2	7.9	12.7	10	7.9	11.8	9.6	7.8	10.6	9			9.6	105
110	7.6	6.8	6.4		12.7	10	7.7	12.3	9.8	7.8	11.5	9.3	7.7	10.4	8.8	7.3		9.5	110
115	7.3	6.7	6.4		12.3	9.7	7.6	12	9.6	7.6	11.3	9.2	7.5	10.2	8.6	7.3		9.4	115
120	7.1	6.6			11.9	9.4	7.4	11.7	9.3	7.4	11	9	7.4	10	8.5	7.2		9.3	120
125					11.6	9.2	7.3	11.4	9.1	7.3	10.7	8.8	7.3	9.8	8.3	7.1		9.1	125
130					11.2	9	7.2	11.1	8.9	7.2	10.5	8.6	7.2	9.7	8.2	7		9.1	130
135					10.9	8.8	7	10.8	8.8	7.1	10.3	8.4	7	9.5	8	6.9		8.8	135
140					10.6	8.7	6.9	10.5	8.6	7	10	8.3	6.9	9.3	7.9	6.8		8.7	140
145					10.3	8.5	6.9	10.2	8.4	6.9	9.8	8.1	6.9	9.2	7.8	6.8		8.5	145
150					10.1	8.3	6.8	10	8.2	6.8	9.6	8	6.8	9	7.7	6.7		8.4	150
155					9.9	8.1	6.7	9.8	8.1	6.7	9.4	7.9	6.7	8.9	7.6	6.6		8.3	155
160					9.6	7.9	6.6	9.6	8	6.7	9.2	7.8	6.6	8.7	7.5	6.6		8.2	160
165					9.4	7.8	6.5	9.4	7.9	6.6	9	7.7	6.6	8.6	7.4	6.5		8	165
170					9.2	7.6	6.5	9.2	7.8	6.5	8.9	7.6	6.5	8.5	7.3	6.5		7.9	170
175					9	7.5	6.5	9.1	7.6	6.5	8.8	7.5	6.5	8.3	7.2	6.4		7.6	175
180					8.8	7.4	6.4	8.9	7.5	6.4	8.6	7.4	6.5	8.2	7.1	6.4		7.2	180
185					8.6	7.2	6.4	8.7	7.3	6.4	8.5	7.3	6.4	8	7.1	6.3		6.9	185
190					8.4	7.1	6.4	8.5	7.2	6.4	8.3	7.2	6.4	7.8	7	6.3		6.5	190
195					8.2	7	6.4	8.4	7.1	6.4	8	7.1	6.4	7.4	7	6.3		6.2	195
200					8.1	6.8	6.4	8.1	7	6.4	7.6	7.1	6.3	7.1	6.9	6.3		5.9	200
205					8	6.7	6.4	7.9	6.9	6.4	7.2	7	6.3	6.8	6.9	6.3		5.6	205
210					7.8	6.7	6.4	7.7	6.8	6.4	6.9	6.9	6.3	6.5	6.8	6.3		5.3	210
215					7.6	6.6	6.4	7.4	6.7	6.4	6.7	6.8	6.3	6.2	6.6	6.3		4.9	215
220					7.4	6.6	6.4	7.1	6.7	6.4	6.4	6.5	6.3	5.9	6.4	6.3		4.7	220
225					7.3	6.6	6.4	6.9	6.6	6.4	6.1	6.3	6.3	5.5	6	6.2		4.4	225
230					7.1	6.6		6.6	6.5	6.4	5.8	6.1	6.3	5.2	5.8	6		4.1	230
235					6.9	6.6		6.4	6.4	6.4	5.6	5.9	6.1	4.9	5.4	5.7		3.8	235
240								6.1	6.2	6.2	5.4	5.7	5.8	4.5	5.1	5.3		3.6	240
245								5.9	5.9		5.2	5.5	5.5	4.2	4.8	5		3.3	245
250								5.7	5.7		5	5.2	5.3	3.9	4.5	4.6		3	250
255								5.4	5.5		4.8	5	5	3.7	4.1	4.3		2.7	255
260											4.6	4.8		3.4	3.8	3.8		2.4	260
265											4.4	4.6		3.1	3.4	3.4		2.6	265
270														2.8	3.1	3			270
275														2.5	2.8	2.7			275
280														2.3	2.4				280
I	0				46/ 0			92/46/ 0			92/46			92				100	I
II	0				92/46			92/92/92			92/92			92				100	II
III	0				92/92			92/92/92			92/92			92				100	III
IV	0				46/92			46/92/92			92/92			92				100	IV
V	0				46/92			46/46/92			46/92			92				100	V

* three-parted folding jib / fléchette pliante à 3 éléments

TAB 131246.4/6 / 131254.4/6 / 131262.4/6

Lifting capacities on the folding jib. Forces de levage à la fléchette pliante.

LTM 1250/1



51 ft – 236 ft

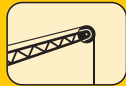

118 ft*



360°



187400 lbs

85%

ft	51 ft			170 ft			187 ft			204 ft			221 ft			236 ft			ft
	0°	20°	40°	0°	20°	40°	0°	20°	40°	0°	20°	40°	0°	20°	40°	0°	20°	40°	
18 - 38	8.7																		18 - 38
40	8.7																		40
45	8.4																		45
50	8			8.5															50
55	7.6	6.1		8.5			7.8												55
60	7.2	6.1		8.5			7.8												60
65	6.9	6.1		8.5			7.8			6.8									65
70	6.5	5.9		8.5			7.8			6.8			5.8						70
75	6.2	5.7		8.5			7.8			6.8			5.8			4.9			75
80	6	5.4		8.5			7.8			6.8			5.8			4.9			80
85	5.7	5.2		8.3			7.8			6.8			5.8			4.9			85
90	5.4	5	4.4	8.1	6.1		7.7	5.8		6.8			5.8			4.9			90
95	5.2	4.7	4.3	7.8	6		7.6	5.8		6.8			5.8			4.9			95
100	5	4.6	4.2	7.6	6		7.3	5.7		6.8	5.1		5.8	4.6		4.9			100
105	4.9	4.4	4	7.4	5.8		7.1	5.6		6.6	5.1		5.8	4.6		4.9			105
110	4.7	4.3	3.9	7.2	5.7		6.9	5.5		6.5	5.1		5.8	4.6		4.9	4.1		110
115	4.6	4.2	3.8	7	5.5	4.1	6.7	5.4		6.3	5.1		5.7	4.6		4.9	4.1		115
120	4.5	4.1	3.7	6.8	5.3	4.1	6.5	5.3	3.9	6.2	5.1		5.6	4.6		4.9	4.1		120
125	4.3	3.9	3.6	6.6	5.2	4.1	6.4	5.1	3.9	6	4.9		5.6	4.6		4.9	4.1		125
130	4.2	3.9	3.5	6.4	5.1	4.1	6.2	5	3.9	5.9	4.8	3.6	5.4	4.6		4.9	4.1		130
135	4.1	3.8	3.4	6.2	5	4	6.1	4.9	3.9	5.7	4.7	3.6	5.3	4.5	3.5	4.9	4.1		135
140	4	3.7	3.4	6.1	4.8	3.9	5.9	4.8	3.9	5.6	4.6	3.6	5.2	4.4	3.5	4.8	4.1	3.2	140
145	3.9	3.6	3.4	5.9	4.7	3.9	5.8	4.7	3.9	5.5	4.6	3.6	5.1	4.3	3.5	4.8	4.1	3.2	145
150	3.8	3.5	3.4	5.8	4.6	3.9	5.7	4.6	3.7	5.4	4.5	3.6	5	4.2	3.5	4.7	4	3.2	150
155	3.7	3.4		5.6	4.5	3.8	5.6	4.5	3.6	5.3	4.4	3.6	4.9	4.2	3.5	4.6	4	3.2	155
160				5.5	4.4	3.7	5.4	4.4	3.6	5.2	4.3	3.6	4.9	4.1	3.5	4.6	3.9	3.2	160
165				5.3	4.4	3.7	5.3	4.3	3.6	5.1	4.2	3.6	4.8	4	3.5	4.5	3.9	3.2	165
170				5.2	4.4	3.7	5.2	4.3	3.6	5	4.1	3.5	4.7	4	3.5	4.4	3.8	3.2	170
175				5.1	4.3	3.6	5.1	4.2	3.6	4.9	4.1	3.5	4.6	3.9	3.5	4.4	3.8	3.2	175
180				5	4.2	3.6	5	4.2	3.6	4.8	4	3.5	4.6	3.9	3.4	4.3	3.7	3.2	180
185				4.9	4.2	3.6	4.9	4.1	3.6	4.7	4	3.5	4.5	3.8	3.4	4.3	3.7	3.2	185
190				4.8	4.1	3.5	4.8	4.1	3.5	4.6	4	3.5	4.4	3.8	3.4	4.2	3.6	3.2	190
195				4.7	4	3.5	4.7	4	3.5	4.6	3.9	3.5	4.4	3.7	3.4	4.1	3.6	3.2	195
200				4.6	4	3.5	4.6	4	3.5	4.5	3.9	3.5	4.3	3.7	3.4	4.1	3.6	3.2	200
205				4.6	3.9	3.4	4.6	3.9	3.4	4.4	3.9	3.4	4.2	3.7	3.4	4.1	3.5	3.2	205
210				4.5	3.9	3.4	4.5	3.9	3.4	4.4	3.8	3.4	4.2	3.7	3.4	4	3.5	3.2	210
215				4.4	3.8	3.4	4.4	3.8	3.4	4.3	3.8	3.4	4.1	3.7	3.4	3.9	3.5	3.2	215
220				4.3	3.8	3.4	4.4	3.8	3.4	4.3	3.7	3.4	4.1	3.6	3.4	3.8	3.4	3.2	220
225				4.2	3.7	3.4	4.3	3.8	3.4	4.2	3.7	3.4	4.1	3.6	3.4	3.7	3.4	3.2	225
230				4.2	3.7	3.4	4.3	3.7	3.4	4.1	3.7	3.4	4	3.6	3.4	3.4	3.4	3.2	230
235				4.1	3.6	3.4	4.2	3.7	3.4	4.1	3.6	3.4	4	3.6	3.4	3.2	3.3	3.2	235
240				4.1	3.6	3.4	4.1	3.6	3.4	4	3.6	3.4	3.9	3.5	3.4	2.9	3.3	3.2	240
245				4	3.5	3.4	4.1	3.6	3.4	4	3.5	3.4	3.8	3.5	3.3	2.7	3.2	3.2	245
250				3.9	3.5	3.4	4	3.6	3.4	3.9	3.5	3.4	3.6	3.4	3.3		3.1	3.2	250
255				3.9	3.5	3.4	4	3.5	3.4	3.9	3.5	3.4	3.3	3.4	3.3		3	3.2	255
260				3.8	3.4		3.9	3.5	3.4	3.8	3.4	3.4	3	3.4	3.3		2.8	3.2	260
265				3.7	3.4		3.8	3.4	3.4	3.8	3.4	3.4	2.7	3.3	3.3		2.6	3.1	265
270							3.7	3.4		3.6	3.3	3.3	2.5	3.2	3.2			2.9	270
275							3.7	3.4		3.4	3.3	3.2	2.2	2.9	3.2			2.6	275
280							3.7	3.4		3.3	3.3	3.2		2.6	2.9			2.3	280
285							3.6			3.1	3.2				2.5				285
290										2.9	3.1								290
295										2.7	2.9								295
300										2.6	2.7								300
I	0			46/0			92/46/0			92/46			92			100			I
II	0			92/46			92/92/92			92/92			92			100			II
III	0			92/92			92/92/92			92/92			92			100			III
IV	0			46/92			46/92/92			92/92			92			100			IV
V	0			46/92			46/46/92			46/92			92			100			V

* four-parted folding jib / fléchette pliante à 4 éléments

TAB 131246.6/6 / 131254.6/6 / 131262.6/6

Lifting heights. Hauteurs de levage.

LTM 1250/1

Folding jib.
Fléchette pliante.

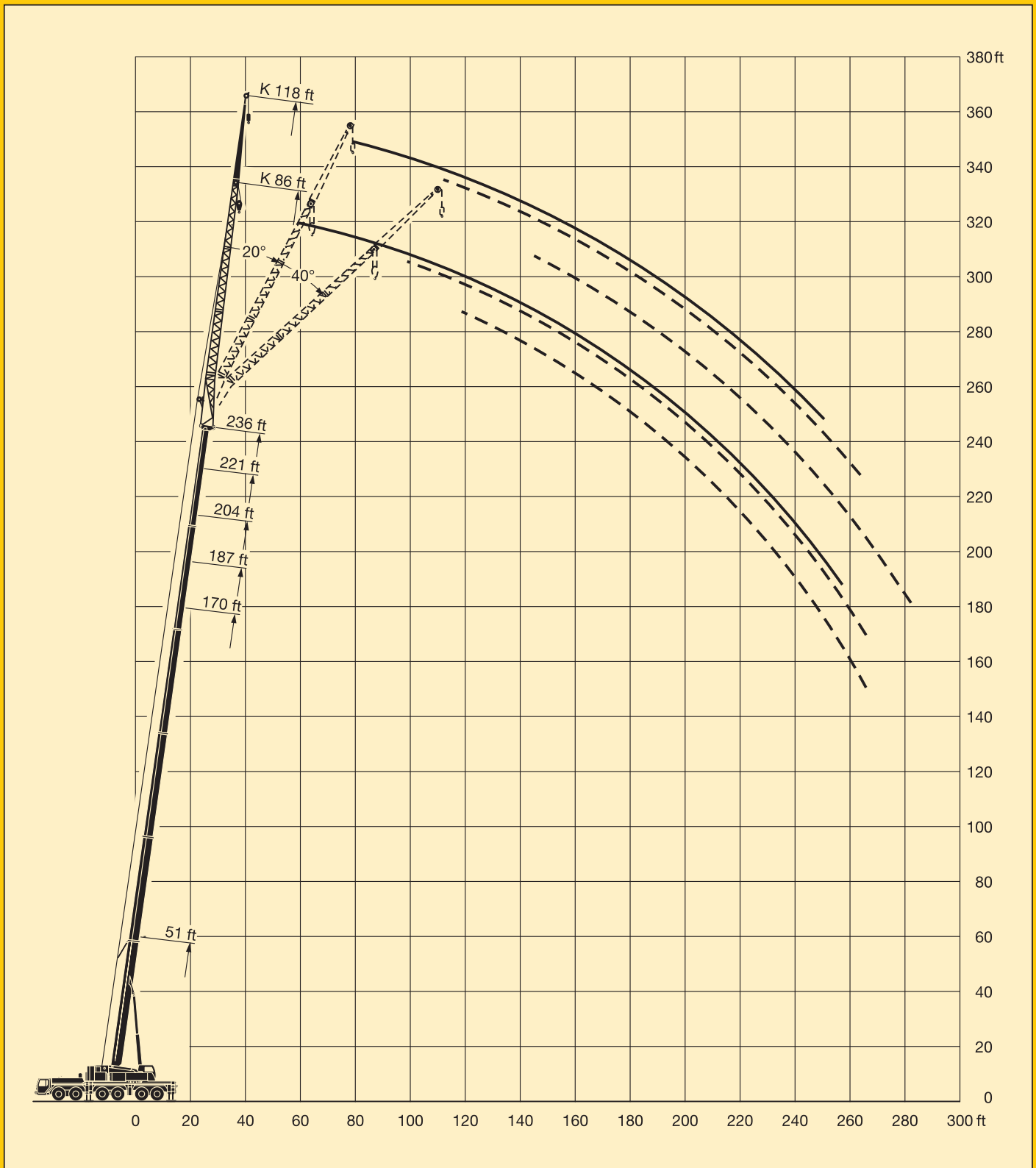

Lifting capacities on the lattice fly jib. Forces de levage à la fléchette treillis fixe.

LTM 1250/1



51 ft - 170 ft



0°
46 ft - 138 ft



360°



187400 lbs

85%

ft	51 ft + 5 ft*					170 ft + 5 ft*					ft
	46 ft	69 ft	92 ft	115 ft	138 ft	46 ft	69 ft	92 ft	115 ft	138 ft	
9 - 12	43.3										9 - 12
13	43.3	33									13
14	43.3	32.9									14
15	43.3	32.9									15
16	43.1	32.7									16
17	42.8	32.5									17
18	42.5	32.3	24.4								18
20	41.9	31.8	24.3								20
22	41.1	31.2	23.8								22
24	40.1	30.6	23.3								24
26	39	29.9	22.8								26
28	37.8	29.2	22.2	16.7							28
30	36.6	28.6	21.7	16.6							30
32	35	27.9	21.1	16.2	12.3	43.3					32
34	33.6	27.4	20.6	15.9	12.2	43.3					34
36	32.1	26.8	20.1	15.5	11.9	43.3					36
38	30.8	26.2	19.7	15.2	11.6	43.3	32.4				38
40	29.4	25.7	19.2	14.9	11.4	43.3	32.3				40
45	26.3	24.3	18.2	14	10.8	42.6	31.8	23.5			45
50	23.3	22.9	17.2	13.3	10.2	41.9	31	23	16.8	12.6	50
55	20.6	21.4	16.3	12.5	9.7	41	30.2	22.3	16.6	12.4	55
60	18.2	19.8	15.4	11.8	9.1	39.9	29.3	21.5	16.1	12	60
65	16	18.1	14.7	11.2	8.6	38.6	28.4	20.8	15.5	11.6	65
70	14	16.3	14	10.6	8.1	37.2	27.7	20.1	15	11.2	70
75	12.3	14.6	13.4	10	7.7	35.6	27	19.5	14.6	10.9	75
80	10.8	13	12.8	9.5	7.2	33.9	26.2	18.9	14.1	10.5	80
85	9.4	11.5	12.1	9	6.8	32.2	25.5	18.3	13.6	10.2	85
90	8.1	10.4	11.5	8.6	6.4	30.7	24.8	17.7	13.2	9.8	90
95		9.3	10.7	8.3	6.1	29.1	24.2	17.2	12.7	9.5	95
100		8.3	9.8	7.9	5.8	27.7	23.5	16.7	12.3	9.2	100
105		7.3	8.8	7.4	5.6	26.3	22.8	16.2	11.9	8.8	105
110		6.4	8	7	5.4	24.9	22	15.8	11.5	8.5	110
115			7.2	6.6	5.2	23.5	21.2	15.3	11.1	8.2	115
120			6.5	6.3	4.9	22.3	20.4	14.9	10.8	7.9	120
125			5.8	6.1	4.7	21.1	19.6	14.5	10.5	7.7	125
130			5.1	5.8	4.4	19.9	18.7	14.1	10.2	7.4	130
135			4.4	5.3	4.2	18.8	17.8	13.7	9.8	7.1	135
140				4.7	4	17.8	16.8	13.4	9.5	6.9	140
145				4.1	3.9	16.8	15.9	13.1	9.2	6.6	145
150				3.6	3.8	15.8	15.1	12.8	9	6.4	150
155				3	3.5	14.8	14.3	12.4	8.7	6.2	155
160					3.1	14	13.5	12.1	8.5	6	160
165					2.7	13.2	12.7	11.7	8.3	5.8	165
170					2.5	12.5	11.9	11.4	8.1	5.7	170
175					2.4	11.8	11.3	11	7.9	5.6	175
180					2.4	11.2	10.7	10.5	7.6	5.5	180
185						10.5	10.1	9.9	7.3	5.3	185
190						9.9	9.6	9.3	7.1	5.2	190
195						9.3	9.1	8.8	6.8	5	195
200						8.7	8.6	8.4	6.6	4.9	200
205							8.1	7.9	6.4	4.7	205
210							7.6	7.5	6.3	4.6	210
215							7.1	7.1	6.2	4.4	215
220							6.7	6.7	6	4.3	220
225								6.3	5.9	4.1	225
230								6	5.6	4.1	230
235								5.6	5.3	4	235
240								5.2	5	3.9	240
245								4.9	4.6	3.8	245
250									4.3	3.7	250
255									4	3.6	255
260									3.7	3.4	260
265									3.4	3.1	265
270										2.8	270
275										2.5	275

* adapter / pièce d'adaptateur

TAB 131562.1/2

Lifting capacities on the lattice fly jib. Forces de levage à la fléchette treillis fixe.

LTM 1250/1



187 ft – 236 ft



0°
46 ft – 138 ft



360°



187400 lbs

85%

ft	187 ft + 5 ft*					204 ft + 5 ft*				221 ft + 5 ft*				236 ft + 5 ft*	ft
	46 ft	69 ft	92 ft	115 ft	138 ft	46 ft	69 ft	92 ft	115 ft	46 ft	69 ft	92 ft	115 ft	115 ft	
36	35.1														36
38	35.1														38
40	35.1														40
45	34.9	26.2	20.7			28.1	20.9			21.1					45
50	34.8	26.1	20.4	15.3		27.9	20.9	16.7		21.1	16.6				50
55	34.4	25.9	20	15.1	10.9	27.8	20.9	16.7	12.7	21.1	16.6	12.9			55
60	33.6	25.5	19.3	14.7	10.9	27.5	20.8	16.7	12.7	21	16.6	12.9			60
65	32.6	25.1	18.8	14.3	10.6	26.9	20.7	16.5	12.4	20.9	16.5	12.9	9		65
70	31.6	24.8	18.3	13.9	10.3	26.3	20.6	16.2	12.1	20.7	16.5	12.9	9		70
75	30.5	24.5	17.8	13.4	10	25.6	20.3	15.8	11.8	20.3	16.3	12.9	9		75
80	29.3	24.2	17.4	13	9.7	24.8	19.9	15.5	11.5	19.9	16	12.8	9		80
85	27.9	23.8	17	12.6	9.4	24.1	19.5	15.2	11.2	19.5	15.7	12.6	9	6.6	85
90	26.6	23	16.6	12.2	9.1	23.2	19.1	14.9	10.9	19.1	15.4	12.4	9	6.6	90
95	25.4	22.2	16.2	11.9	8.8	22.2	18.6	14.7	10.7	18.5	15	12.1	9	6.6	95
100	24.2	21.3	15.7	11.5	8.5	21.2	17.9	14.4	10.4	17.9	14.7	11.9	9	6.6	100
105	23.1	20.5	15.3	11.2	8.2	20.3	17.3	14	10.2	17.3	14.2	11.6	8.9	6.6	105
110	22	19.6	15	10.9	8	19.4	16.7	13.7	9.9	16.7	13.8	11.3	8.7	6.6	110
115	21	18.8	14.6	10.6	7.7	18.5	16.1	13.5	9.7	16.2	13.4	10.9	8.5	6.6	115
120	19.9	17.9	14.2	10.3	7.5	17.7	15.5	13.2	9.4	15.6	13	10.6	8.4	6.6	120
125	18.9	17.2	13.9	10	7.2	16.9	15	12.9	9.2	15	12.6	10.3	8.1	6.6	125
130	18	16.4	13.6	9.7	7	16.1	14.4	12.4	9	14.5	12.3	10	7.9	6.6	130
135	17	15.7	13.3	9.4	6.8	15.3	13.8	12	8.8	14	11.9	9.7	7.6	6.5	135
140	16.1	15	13	9.2	6.6	14.6	13.2	11.6	8.6	13.4	11.5	9.4	7.4	6.4	140
145	15.2	14.2	12.7	8.9	6.4	13.8	12.7	11.2	8.4	12.8	11.1	9.1	7.2	6.2	145
150	14.3	13.6	12.4	8.7	6.2	13.1	12	10.8	8.2	12.2	10.7	8.9	6.9	6	150
155	13.4	12.9	11.9	8.5	6	12.4	11.5	10.4	8	11.6	10.3	8.6	6.7	5.8	155
160	12.7	12.2	11.3	8.2	5.8	11.7	10.9	9.9	7.8	11	9.9	8.3	6.5	5.5	160
165	12.1	11.5	10.8	8.1	5.7	11	10.3	9.4	7.6	10.5	9.4	8.1	6.3	5.3	165
170	11.5	10.8	10.3	7.9	5.5	10.5	9.8	9	7.5	9.9	9	7.8	6.1	5.1	170
175	10.9	10.2	9.7	7.8	5.4	10	9.3	8.6	7.3	9.4	8.5	7.5	5.9	4.8	175
180	10.3	9.5	9.2	7.6	5.3	9.5	8.7	8.1	7	8.9	8.1	7.2	5.8	4.5	180
185	9.8	9	8.7	7.4	5.2	9.1	8.2	7.7	6.7	8.4	7.7	6.8	5.6	4.3	185
190	9.2	8.6	8.1	7.2	5.1	8.7	7.7	7.3	6.3	7.8	7.3	6.5	5.4	4	190
195	8.7	8.3	7.6	7	5	8.3	7.2	6.9	6	7.3	6.9	6.1	5.1	3.7	195
200	8.2	7.9	7.1	6.7	4.9	8	6.9	6.5	5.6	6.8	6.5	5.8	4.8	3.4	200
205	7.7	7.6	6.7	6.3	4.8	7.6	6.6	6.1	5.3	6.4	6	5.5	4.5	3.1	205
210	7.2	7.1	6.4	5.9	4.6	7.2	6.4	5.7	4.9	6.1	5.6	5.1	4.2		210
215	6.7	6.7	6.1	5.5	4.5	6.8	6.1	5.4	4.6	5.7	5.2	4.8	3.9		215
220		6.3	5.9	5.1	4.4	6.3	5.8	5.1	4.3	5.3	4.9	4.5	3.7		220
225		5.9	5.6	4.8	4.2	5.9	5.6	4.9	4	5	4.5	4.1	3.4		225
230		5.5	5.3	4.6	4	5.6	5.3	4.7	3.8	4.6	4.1	3.8	3.1		230
235		5.1	5	4.4	3.6	5.2	5	4.5	3.5	4.2	3.8	3.4	2.8		235
240		4.7	4.7	4.2	3.4		4.7	4.3	3.3	3.8	3.5	3.1	2.5		240
245			4.4	3.9	3.1		4.3	4	3.1	3.5	3.1	2.8			245
250			4	3.6	2.9		4	3.7	2.9			2.8			250
255			3.7	3.2	2.7		3.7	3.4	2.6			2.5			255
260			3.3	2.9	2.5			3.1	2.4						260
265				2.6				2.8							265
270								2.5							270
275								2.2							275
I	92/46					92/46				92				100	I
II	92/92					92/92				92				100	II
III	92/92					92/92				92				100	III
IV	46/92					92/92				92				100	IV
V	46/46					46/92				92				100	V

* adapter / pièce d'adaptateur

TAB 131562.3/4/5

Lifting capacities on the lattice fly jib. Forces de levage à la fléchette treillis fixe.

LTM 1250/1



51 ft - 170 ft



20°
46 ft - 138 ft



360°



187400 lbs

85%

ft	51 ft + 5 ft*					170 ft + 5 ft*					ft
	46 ft	69 ft	92 ft	115 ft	138 ft	46 ft	69 ft	92 ft	115 ft	138 ft	
26	39										26
28	38										28
30	36.8										30
32	35.7										32
34	34.6										34
36	33.5	24.2									36
38	32.5	23.7									38
40	31.6	23.2									40
45	29.5	22									45
50	27.6	21	14.9			37.3					50
55	25.1	20.1	14.6			36.6					55
60	22.2	19.3	13.9			35.4					60
65	19.4	18.6	13.2	9.9		34.1	22.8				65
70	16.9	18	12.6	9.4	7	33	22.3				70
75	14.6	17.3	12.1	8.9	6.8	32	21.7	14.6			75
80	12.6	16.4	11.6	8.5	6.4	31	21.2	14.5			80
85	10.6	15.1	11.2	8.1	6	30.1	20.8	14.2			85
90	8.9	13.4	10.8	7.7	5.7	29.2	20.3	13.8	9.7		90
95		11.8	10.4	7.3	5.4	28.4	19.9	13.4	9.5		95
100		10.3	10.1	7	5.2	27.7	19.6	13.1	9.3	6.4	100
105		8.8	9.7	6.6	4.9	26.9	19.2	12.8	9	6.4	105
110		7.3	9.4	6.4	4.7	25.5	18.8	12.5	8.7	6.2	110
115			9	6.2	4.5	24.2	18.5	12.3	8.5	6	115
120			8.3	6	4.3	23	18.2	12	8.3	5.8	120
125			7.2	5.8	4.1	21.8	17.9	11.8	8.1	5.6	125
130			6.1	5.6	4	20.6	17.6	11.5	7.8	5.5	130
135			5.1	5.5	3.8	19.5	17.3	11.3	7.6	5.3	135
140				5.5	3.7	18.4	17	11.1	7.4	5.1	140
145				5.4	3.6	17.4	16.6	10.9	7.2	5	145
150				4.8	3.4	16.3	16.1	10.7	7	4.9	150
155				4	3.4	15.4	15.4	10.5	6.8	4.7	155
160					3.3	14.6	14.6	10.3	6.7	4.6	160
165					3.3	13.7	13.8	10.2	6.5	4.5	165
170					3.3	13	13	10	6.4	4.4	170
175					2.8	12.2	12.3	9.8	6.3	4.3	175
180						11.4	11.6	9.7	6.2	4.2	180
185						10.7	10.9	9.5	6	4.1	185
190						10	10.3	9.4	6	4	190
195							9.7	9.3	5.8	3.9	195
200							9.1	9.1	5.7	3.8	200
205							8.5	8.7	5.6	3.8	205
210								8.1	5.6	3.7	210
215								7.6	5.5	3.6	215
220								7.2	5.5	3.5	220
225								6.7	5.5	3.5	225
230								6.2	5.5	3.4	230
235								5.7	5.4	3.4	235
240									5.3	3.4	240
245									5.1	3.3	245
250									4.7	3.3	250
255									4.4	3.3	255
260										3.3	260
265										3.3	265
270										3.2	270
275										3	275
280										2.6	280
I			0					92/46			I
II			0					92/92			II
III			0					46/92			III
IV			0					46/46			IV
V			0					46/46			V

* adapter / pièce d'adaptateur

TAB 131572.1/2

Lifting capacities on the lattice fly jib. Forces de levage à la fléchette treillis fixe.

LTM 1250/1



187 ft – 236 ft



20°
46 ft – 138 ft



360°



187400 lbs

85%

ft	187 ft + 5 ft*					204 ft + 5 ft*				221 ft + 5 ft*				236 ft + 5 ft*	ft
	46 ft	69 ft	92 ft	115 ft	138 ft	46 ft	69 ft	92 ft	115 ft	46 ft	69 ft	92 ft	115 ft	115 ft	
55	33.1														55
60	32.9														60
65	32					25.8									65
70	31.1	20.9				25.1				20.3					70
75	30.2	20.7				24.4	18.9			20					75
80	29.2	20.3				23.7	18.8			19.4					80
85	28.2	19.9	13.6			23	18.5			18.9	15.3				85
90	27.1	19.5	13.3			22.3	18.1	12.3		18.4	14.9				90
95	26.1	19.2	13	9		21.5	17.7	12.2		17.9	14.5	11.1			95
100	25.1	18.8	12.7	8.9		20.7	17.2	11.9	8.1	17.4	14.1	11			100
105	24	18.5	12.4	8.6		20	16.8	11.7	8.1	16.9	13.7	10.8			105
110	22.9	18.3	12.1	8.4	5.9	19.3	16.3	11.5	7.9	16.4	13.3	10.7	7.2		110
115	21.8	18	11.9	8.2	5.8	18.6	15.9	11.3	7.7	15.9	12.9	10.5	7.1	6.5	115
120	20.7	17.7	11.7	8	5.6	18	15.4	11.1	7.6	15.4	12.6	10.3	7	6.5	120
125	19.6	17.5	11.4	7.8	5.5	17.4	14.8	10.9	7.4	14.9	12.2	10	6.8	6.3	125
130	18.6	17.1	11.2	7.6	5.3	16.8	14.3	10.8	7.2	14.4	11.9	9.7	6.7	6.3	130
135	17.6	16.5	11.1	7.4	5.2	16.1	13.9	10.6	7.1	13.9	11.6	9.4	6.6	6.2	135
140	16.7	15.9	10.9	7.3	5	15.4	13.4	10.4	7	13.4	11.2	9.1	6.5	6.1	140
145	15.8	15.2	10.7	7.1	4.9	14.6	12.9	10.3	6.8	13	10.9	8.9	6.3	6	145
150	14.9	14.5	10.5	6.9	4.8	13.9	12.5	10.2	6.7	12.5	10.6	8.6	6.3	5.9	150
155	14	13.7	10.3	6.8	4.7	13.1	12.1	10	6.6	12.1	10.3	8.4	6.2	5.8	155
160	13.2	13	10.2	6.7	4.6	12.4	11.7	9.9	6.5	11.6	9.9	8.1	6.1	5.7	160
165	12.4	12.3	10.1	6.5	4.4	11.7	11.2	9.7	6.3	11.1	9.6	7.9	6	5.5	165
170	11.8	11.7	9.9	6.4	4.4	11.1	10.7	9.4	6.2	10.5	9.3	7.7	6	5.3	170
175	11.3	11	9.8	6.2	4.2	10.4	10.1	9.1	6.1	9.9	8.9	7.5	5.9	5.2	175
180	10.7	10.4	9.7	6.1	4.1	9.8	9.5	8.8	6	9.3	8.6	7.3	5.7	5.1	180
185	10.1	9.8	9.5	6	4.1	9.4	8.9	8.4	5.9	8.8	8.3	7.1	5.6	4.9	185
190	9.5	9.2	9.1	5.9	4	8.9	8.4	8.2	5.8	8.3	7.9	6.9	5.4	4.8	190
195	8.8	8.6	8.6	5.8	3.9	8.5	7.9	7.7	5.8	7.9	7.5	6.6	5.3	4.7	195
200	8.2	8.1	8.1	5.8	3.8	8.1	7.5	7.3	5.7	7.4	7	6.4	5.1	4.5	200
205		7.7	7.6	5.7	3.8	7.7	7.1	6.8	5.6	7	6.6	6.2	5	4.3	205
210		7.3	7.1	5.6	3.7	7.3	6.7	6.4	5.6	6.5	6.1	6	4.9	4.1	210
215		6.9	6.7	5.5	3.6	6.8	6.4	6	5.5	6.1	5.8	5.7	4.7	3.9	215
220		6.5	6.3	5.4	3.6		6.1	5.7	5.3	5.7	5.5	5.3	4.6	3.6	220
225		6	5.9	5.4	3.5		5.8	5.3	5	5.2	5.1	5	4.4	3.3	225
230			5.6	5.3	3.4		5.5	5	4.7	4.8	4.7	4.6	4.1	3	230
235			5.3	5	3.4		5.2	4.8	4.3	4.4	4.3	4.3	3.8	2.7	235
240			5	4.6	3.3		4.8	4.5	3.9		3.9	3.9	3.5		240
245			4.7	4.3	3.3			4.3	3.6		3.5	3.5	3.2		245
250				4.1	3.3			4.1	3.4		3.1	3.2	2.9		250
255				3.8	3.3			3.8	3.1		2.7	2.8	2.6		255
260				3.5	3			3.5	2.9			2.4	2.2		260
265				3.1	2.8				2.6						265
270				2.8	2.6				2.4						270
275				2.4	2.3				2.2						275
I	92/46					92/46				92				100	I
II	92/92					92/92				92				100	II
III	92/92					92/92				92				100	III
IV	46/92					92/92				92				100	IV
V	46/46					46/92				92				100	V

* adapter / pièce d'adaptateur

TAB 131572.3/4/5

Remarks referring to load charts.

- The tabulated lifting capacities do not exceed 85% of the tipping load.
- The crane's structural steelwork is in accordance with DIN 15018, part 3. Design and construction of the crane comply with DIN 15018, part 2, and with F.E.M. regulations.
- The 85% overturning limit values take into account wind force 5 = wind speed 20 mph.
- Lifting capacities are given in kips.
- The weight of the hook blocks and hooks must be deducted from the lifting capacities.
- Working radii are measured from the slewing centreline.
- The lifting capacities given for the telescopic boom only apply if the folding jib is taken off.
- Lifting capacities are subject to modifications.
- Lifting capacities above 298 kips only with additional pulley block/special equipment.

Remarques relatives aux tableaux des charges.

- Les forces de levage indiquées ne dépassent pas 85% de la charge de basculement.
- La norme DIN 15018, 3ème partie est appliquée pour les charpentes. La construction de la grue est réalisée conformément à la norme DIN 15018, 2ème partie, et aux règles de la F. E. M.
- A 85% de la charge de basculement, il a été tenu compte d'un vent de force 5 = vitesse de vent 20 mph.
- Les forces de levage sont données en kips.
- Le poids des mouffes et crochets doit être soustrait des charges indiquées.
- Les portées sont calculées à partir de l'axe de rotation.
- Les forces indiquées pour la flèche télescopique s'entendent fléchette dépliée déposée.
- Les forces de levage sont modifiables sans préavis.
- Forces de levage plus de 298 kips seulement avec moufle additionnel/équipement supplémentaire.

Lifting capacities on the lattice fly jib. Forces de levage à la fléchette treillis fixe.

LTM 1250/1



51 ft - 170 ft



40°
46 ft - 138 ft



360°



187400 lbs

85%

ft	51 ft + 5 ft*					170 ft + 5 ft*					ft
	46 ft	69 ft	92 ft	115 ft	138 ft	46 ft	69 ft	92 ft	115 ft	138 ft	
38	30.4										38
40	30.2										40
45	28.6										45
50	27.1										50
55	25.6	17.6									55
60	24.2	17.5									60
65	22.5	17				29.6					65
70	19.6	16.6				29.1					70
75	16.7	16.2	10.7			28.5					75
80	14.3	15.8	10.3			27.8					80
85	13.3	15.6	9.9			27.1	17.5				85
90		15.2	9.6	6.5		26.5	17.3				90
95		13.9	9.3	6.3		25.9	17	10.6			95
100		12	9.1	6.1		25.4	16.8	10.5			100
105			8.9	5.8		24.9	16.6	10.3			105
110			8.8	5.7	4	24.4	16.5	10.2			110
115			8.8	5.5	3.9	24	16.3	10	6.3		115
120			8.7	5.4	3.8	23.4	16.1	9.8	6.3		120
125			8.6	5.3	3.6	22.4	15.9	9.7	6.1		125
130			8.5	5.2	3.5	21.2	15.8	9.5	6		130
135				5.2	3.4	20.1	15.7	9.4	5.9	3.9	135
140				5.2	3.3	19	15.6	9.3	5.8	3.9	140
145				5.1	3.2	17.9	15.5	9.1	5.7	3.8	145
150				5.1	3.1	16.9	15.4	9.1	5.6	3.7	150
155					3.1		15.2	9	5.6	3.7	155
160					3.1		14.9	8.9	5.5	3.6	160
165					3.1		14.5	8.9	5.4	3.5	165
170					3.1		13.7	8.8	5.4	3.5	170
175					3.1		12.9	8.8	5.3	3.4	175
180								8.8	5.3	3.4	180
185								8.8	5.2	3.3	185
190								8.8	5.2	3.3	190
195								8.8	5.2	3.2	195
200									5.2	3.2	200
205									5.2	3.2	205
210									5.2	3.1	210
215									5.2	3.1	215
220									5.2	3.1	220
225										3.1	225
230										3.1	230
235										3.1	235
240										3.1	240
I			0					92			I
II			0					92			II
III			0					46			III
IV			0					46			IV
%			0					46			V

* adapter / pièce d'adaptateur

TAB 131582.1/2

Lifting capacities on the lattice fly jib. Forces de levage à la fléchette treillis fixe.

LTM 1250/1



187 ft - 221 ft



40°
46 ft - 138 ft



360°



187400 lbs

85%

ft	187 ft + 5 ft*					204 ft + 5 ft*				221 ft + 5 ft*				ft
	46 ft	69 ft	92 ft	115 ft	138 ft	46 ft	69 ft	92 ft	115 ft	46 ft	69 ft	92 ft	115 ft	
70	28													70
75	27.6					23.5								75
80	27					23.3								80
85	26.4					22.7				18.7				85
90	25.9	16.8				22.1				18.2				90
95	25.4	16.7				21.4	16			17.8				95
100	24.7	16.5	10.2			20.6	15.9			17.3	13.6			100
105	23.9	16.3	10.2			19.9	15.8			16.8	13.6			105
110	23.1	16.2	10			19.2	15.7	9.7		16.4	13.2			110
115	22.4	16	9.8			18.6	15.4	9.6		15.9	12.9			115
120	21.4	15.9	9.7	6		18	15.1	9.5		15.5	12.5	9.1		120
125	20.3	15.8	9.5	6		17.4	14.8	9.4		15	12.2	9.1		125
130	19.3	15.7	9.4	5.9		16.8	14.4	9.2	5.8	14.5	11.9	9		130
135	18.2	15.6	9.3	5.9		16.3	13.9	9.2	5.7	14	11.6	8.9		135
140	17.3	15.5	9.2	5.8	3.8	15.7	13.5	9.1	5.6	13.6	11.3	8.8	5.4	140
145	16.3	15.4	9.1	5.7	3.8	15.2	13	9	5.6	13.1	11	8.8	5.4	145
150	15.5	15	9	5.6	3.7	14.4	12.6	8.9	5.5	12.7	10.7	8.7	5.3	150
155	14.6	14.4	8.9	5.5	3.6	13.6	12.2	8.8	5.4	12.3	10.4	8.5	5.3	155
160	13.7	13.8	8.9	5.5	3.6	12.9	11.8	8.7	5.4	11.9	10.2	8.3	5.2	160
165		13	8.8	5.4	3.5	12.2	11.4	8.7	5.3	11.5	9.8	8	5.2	165
170		12.3	8.8	5.3	3.4	11.5	11.1	8.7	5.3	10.9	9.5	7.8	5.1	170
175		11.7	8.7	5.3	3.4	10.8	10.6	8.7	5.2	10.3	9.1	7.6	5.1	175
180		11	8.7	5.3	3.3		10.1	8.6	5.2	9.7	8.8	7.4	5.1	180
185			8.6	5.2	3.3		9.5	8.5	5.1		8.5	7.3	5	185
190			8.6	5.2	3.2		9	8.3	5.1		8.3	7.1	5	190
195			8.6	5.1	3.2		8.4	8.1	5.1		8	6.8	5	195
200			8.5	5.1	3.2			7.8	5.1		7.5	6.6	5	200
205			8.2	5.1	3.1			7.5	5.1		7.1	6.4	5	205
210				5.1	3.1			7.1	5			6.2	5	210
215				5.1	3.1			6.7	5			6	4.9	215
220				5.1	3.1			6.2	5			5.8	4.8	220
225				5.1	3.1				5			5.5	4.7	225
230					3.1				5				4.5	230
235					3.1				4.9				4.4	235
240					3.1				4.6				4.2	240
245					3.1								3.9	245
250					3.1								3.5	250
255					3.1								3.2	255
I			92					92				92		I
II			92					92				92		II
III			92					92				92		III
IV			46					92				92		IV
V			46					46				92		V

* adapter / pièce d'adaptateur

TAB 131582.3/4/5

Lifting heights. Hauteurs de levage.

LTM 1250/1

Lattice fly jib.
Fléchette treillis fixe.

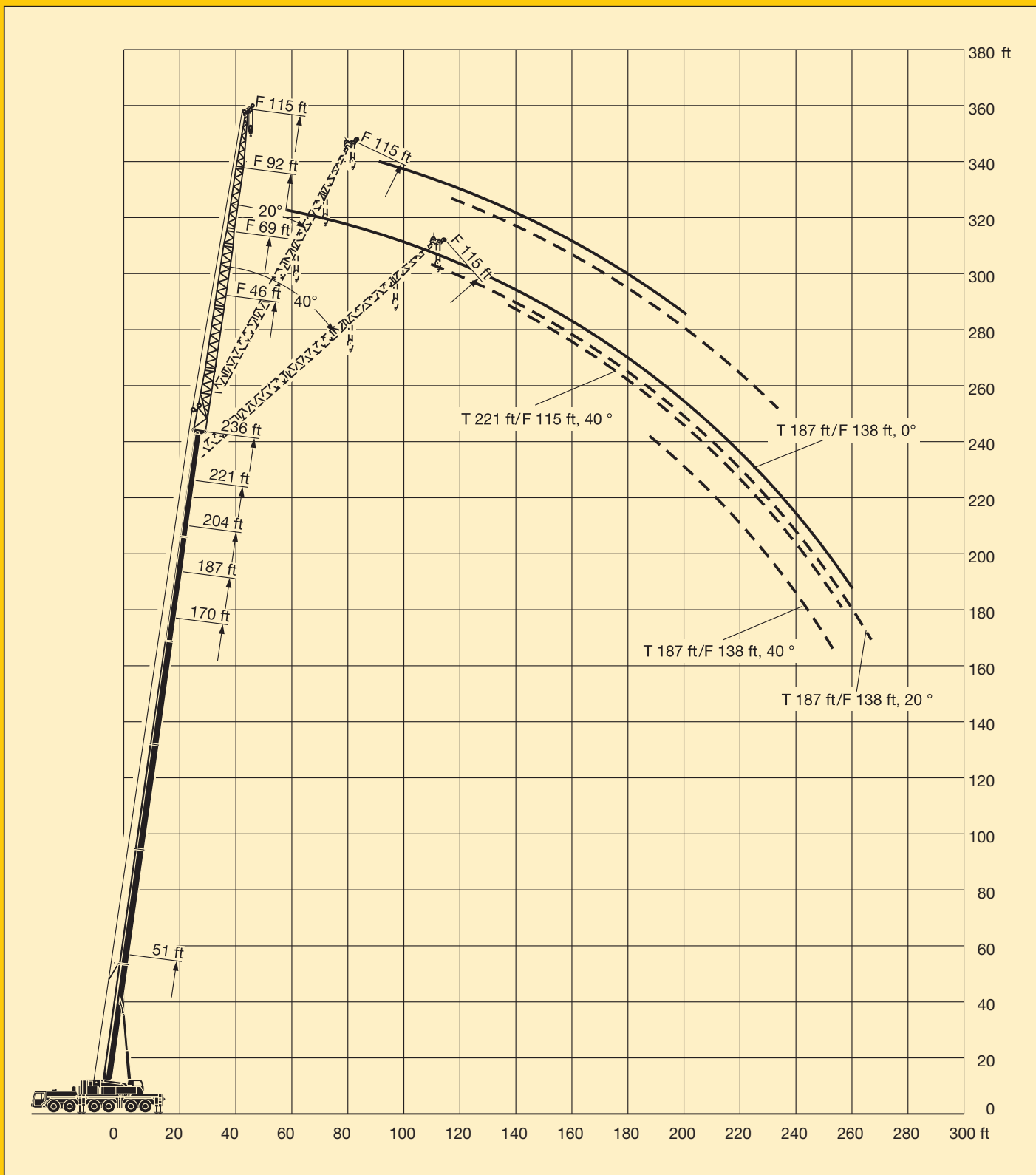

Lifting capacities on the luffing lattice jib. Forces de levage à la flèche treillis relevable.

LTM 1250/1



82°
51 ft – 85 ft



57 ft – 230 ft



360°



214900 lbs



85%

ft	51 ft + 10 ft*										85 ft + 10 ft*										ft
	57 ft	69 ft	92 ft	115 ft	138 ft	161 ft	184 ft	207 ft	230 ft	57 ft	69 ft	92 ft	115 ft	138 ft	161 ft	184 ft	207 ft	230 ft			
22	112																			22	
24	112																				24
26	112	112																			26
28	112	112																			28
30	112	112								95.5											30
32	112	112								95.5	85.5										32
34	112	111								95.5	85.5										34
36	111	109	86.5							95.5	85.5										36
38	111	108	85.5							95.5	85.5										38
40	110	107	84.5							95.5	85.5	67									40
45	106	104	82.5	65.5						95.5	85.5	66.5									45
50	95.5	102	80.5	64.5	50.8					95.5	85.5	66	51.1								50
55	80.5	96.5	79	63.5	50.6	39.8				93	85.5	65.5	50.9	40.3							55
60		86	78	62	50	39.7					85	65.5	50.6	40.3							60
65		72.5	77	61	49.3	39.3	31.1				84.5	65.5	50.3	40	31.8						65
70			73.5	60.5	48.5	38.9	30.8	24.6			77.5	65	50.1	39.8	31.6	24.9					70
75			67.5	59.6	47.8	38.5	30.4	24.4	18.2			65	50	39.5	31.3	24.8	20				75
80			59	59	47.2	38.1	30.1	24.1	18			64.5	50	39.3	31.1	24.6	19.9				80
85			50.5	58.3	46.6	37.6	29.8	23.9	17.3			62.5	49.9	39.1	30.9	24.4	19.7	15.5			85
90			41.3	55.2	46.2	37.2	29.5	23.6	16.6			56.6	49.9	39.1	30.7	24.3	19.6	15.1			90
95				50.7	45.3	36.8	29.3	23.4	16			46.3	49.8	39	30.5	24.1	19.4	14.6			95
100				45.5	44.1	36.5	29	23.1	15.4				49.5	39	30.5	23.9	19.2	14.1			100
105				40.3	42.7	36.1	28.8	22.8	14.8				48.7	39	30.4	23.8	19.1	13.6			105
110				34.5	41.2	35.8	28.6	22.5	14.2				45	38.7	30.3	23.7	18.9	13.2			110
115					39	35.5	28.3	22	13.7				40.3	38.2	30.3	23.6	18.8	12.8			115
120					36	35.2	27.8	21.6	13.2					37.5	30.2	23.4	18.7	12.3			120
125					32.4	34.7	27.3	21.2	12.6					36.5	30.2	23.2	18.6	11.9			125
130					28.6	33.7	26.7	20.7	12.1					34.7	30.1	22.8	18.5	11.5			130
135					23.6	31.5	26.2	20.2	11.6					31.8	30.1	22.5	18.4	11.1			135
140						28.9	25.7	19.7	11.1					27.2	30.1	22.1	18.1	10.7			140
145						26.2	25.3	19.3	10.6						29.9	21.7	17.8	10.2			145
150						23.5	25	18.8	10.2						28.5	21.4	17.5	9.8			150
155						20.6	24.3	18.4	9.7						26.1	21.2	17.2	9.4			155
160							23.1	18	9.3						23.4	21	16.9	9.1			160
165							21.3	17.6	8.9							20.8	16.6	8.7			165
170							19.3	17.2	8.5							20.6	16.3	8.3			170
175							17.3	16.9	8.1							20.5	16.1	8			175
180							14.5	16.6	7.7							19.8	15.8	7.7			180
185								16.2	7.4								15.6	7.3			185
190								15.9	7.1								15.4	7			190
195								14.6	6.8								15.1	6.7			195
200								12.8	6.5								14.9	6.5			200
205									6.2								14.3	6.2			205
210									5.9									6			210
215									5.7									5.7			215
220									5.4									5.5			220
225									5.3									5.3			225
I					0										46						I
II					0										46						II
III					0										0						III
IV					0										0						IV
V					0										0						V

* adapter / pièce d'adaptateur

TAB 131216.1/2

The LTM 1250/1 can be equipped to tackle any job.

Lifting capacities on the luffing lattice jib. Forces de levage à la flèche treillis relevable.

LTM 1250/1



82°
119 ft – 153 ft



57 ft – 230 ft



360°



214900 lbs



ft	119 ft + 10 ft*								153 ft + 10 ft*						ft	
	57 ft	69 ft	92 ft	115 ft	138 ft	161 ft	184 ft	207 ft	57 ft	69 ft	92 ft	115 ft	138 ft	161 ft		184 ft
36	65															36
38	65	57.6														38
40	65	57.5														40
45	65	57.3	44.7						40.3	35.6						45
50	65	57.2	44.6						40.2	35.5	27.8					50
55	65	57.1	44.4	35.6					40.1	35.4	27.7					55
60	65	57.1	44.3	35.6					40.1	35.3	27.6					60
65	65	57.1	44.2	35.4	28.5				40.1	35.2	27.5	21.5				65
70		57.1	44.1	35.3	28.4	22.6			40.1	35.2	27.4	21.4	17.2			70
75		57.1	44.1	35.1	28.2	22.5	18			35.2	27.3	21.3	17.1	13.2		75
80			44.1	35	28.1	22.4	18			35.2	27.3	21.2	17	13.2		80
85			44.1	35	28	22.3	17.9	14.1		35.2	27.3	21.2	16.9	13.1	9.5	85
90			44.1	35	27.9	22.3	17.8	14			27.3	21.1	16.9	13.1	9.5	90
95			44.1	35	27.9	22.2	17.7	14			27.3	21.1	16.8	13	9.5	95
100				35	27.9	22.1	17.6	13.9			27.3	21.1	16.8	12.9	9.5	100
105				35	27.9	22.1	17.5	13.8				21.1	16.8	12.9	9.5	105
110				35	27.9	22.1	17.5	13.8				21.1	16.8	12.8	9.5	110
115				35	27.9	22.1	17.4	13.7				21.1	16.8	12.8	9.5	115
120				35	27.9	22.1	17.4	13.7				21.1	16.8	12.8	9.5	120
125					27.9	22.1	17.4	13.6				21.1	16.8	12.8	9.5	125
130					27.9	22.1	17.4	13.6				21.1	16.8	12.8	9.5	130
135					27.9	22.1	17.4	13.6					16.8	12.8	9.5	135
140					27.9	22.1	17.4	13.6					16.8	12.8	9.5	140
145						22.1	17.4	13.6					16.8	12.8	9.5	145
150						22.1	17.4	13.6					16.8	12.8	9.5	150
155						22.1	17.4	13.6						12.8	9.5	155
160						22.1	17.4	13.6						12.8	9.5	160
165						22.1	17.4	13.6						12.8	9.5	165
170						22.1	17.4	13.6						12.8	9.5	170
175							17.4	13.6							9.5	175
180							17.4	13.6							9.5	180
185							17.4	13.6							9.5	185
190							17.4	13.6							9.5	190
195								13.6							9.5	195
200								13.5								200
205								13.4								205
210								13.3								210
215								13								215
I				92								92				I
II				46								46				II
III				46								46				III
IV				0								46				IV
V				0								46				V

* adapter / pièce d'adaptateur

TAB 131216.3

Lifting capacities on the luffing lattice jib. Forces de levage à la fléchette treillis relevable.

LTM 1250/1



82°
197 ft – 221 ft



57 ft – 207 ft



360°



214900 lbs

85%

ft	187 ft + 10 ft*					204 ft + 10 ft*				221 ft + 10 ft*			ft
	57 ft	69 ft	92 ft	115 ft	138 ft	57 ft	69 ft	92 ft	115 ft	57 ft	69 ft	92 ft	
50	24.1	21.3				18.1				13.1			50
55	24	21.2				18	15.6			13.1			55
60	23.9	21.1				17.9	15.6			13			60
65	23.9	21	16.2			17.8	15.5	11.6		13	11.1		65
70	23.9	20.9	16.1	12.3		17.8	15.4	11.5	7.5	12.9	11	6.8	70
75	23.9	20.9	16.1	12.2	8.5	17.8	15.4	11.5	7.5	12.9	11	6.8	75
80		20.9	16	12.2	8.5		15.4	11.4	7.5		10.9	6.8	80
85		20.9	16	12.1	8.5		15.4	11.3	7.5		10.9	6.8	85
90			16	12	8.5		15.4	11.3	7.5		10.9	6.8	90
95			16	12	8.5			11.3	7.5			6.8	95
100			15.9	12	8.5			11.2	7.5			6.8	100
105			15.9	12	8.5			11.2	7.5			6.8	105
110			15.9	12	8.5			11.2	7.5			6.8	110
115				12	8.5				7.5				115
120				12	8.5				7.5				120
125				12	8.5				7.5				125
130				12	8.5				7.5				130
135					8.5				7.5				135
140					8.5								140
145					8.5								145
150					8.5								150
155					8.5								155
I			92					92			92		I
II			92					92			92		II
III			92					92			92		III
IV			46					92			92		IV
V			46					46			92		V

* adapter / pièce d'adaptateur

TAB 131216.4

Lifting heights. Hauteurs de levage.

LTM 1250/1

Luffing lattice jib.
Fléchette treillis relevable.

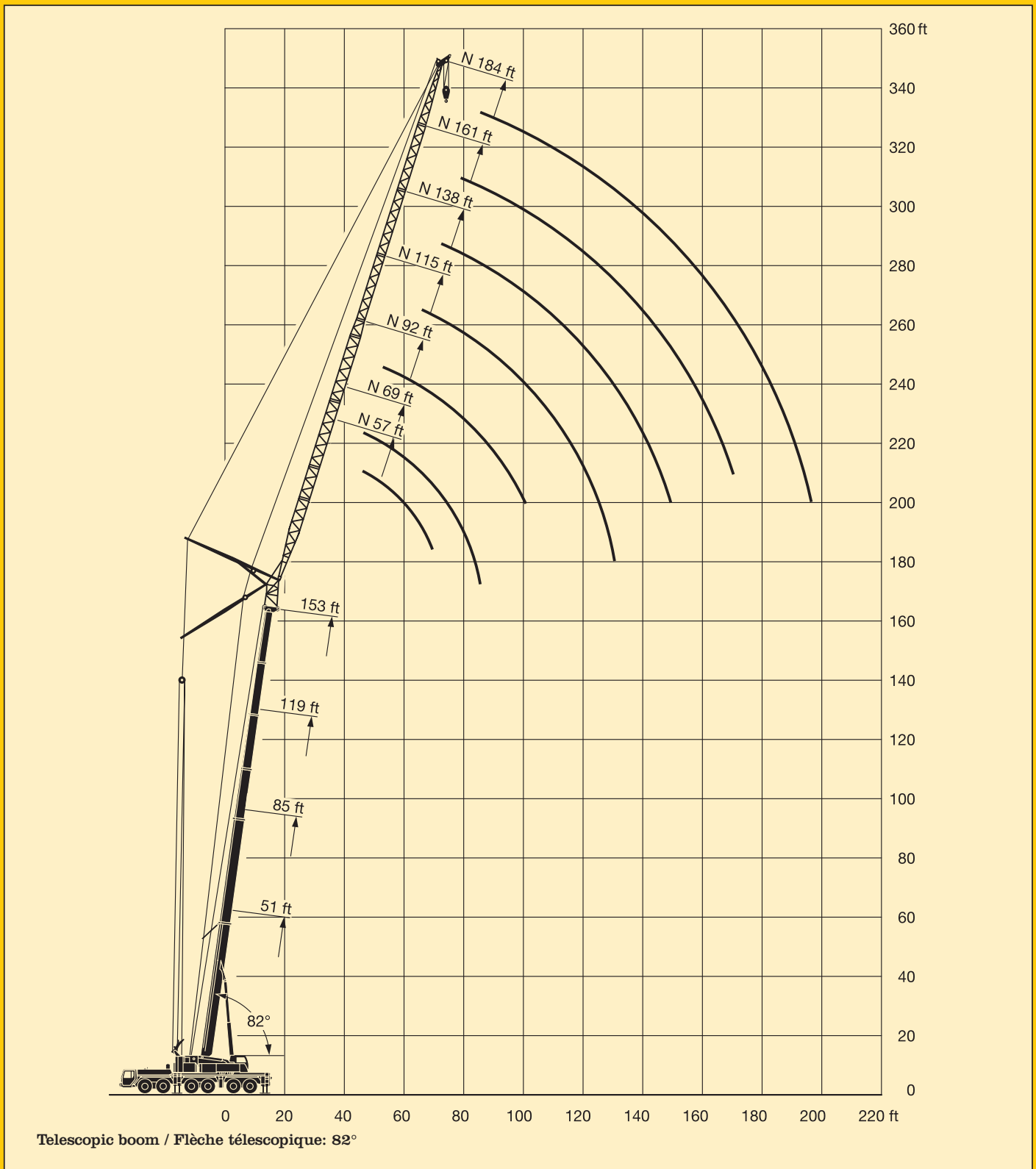

Lifting capacities on the luffing lattice jib. Forces de levage à la flèche treillis relevable.

LTM 1250/1



75°
51 ft - 85 ft



57 ft - 230 ft



360°



214900 lbs



85%

ft	51 ft + 10 ft*									85 ft + 10 ft*									ft	
	57 ft	69 ft	92 ft	115 ft	138 ft	161 ft	184 ft	207 ft	230 ft	57 ft	69 ft	92 ft	115 ft	138 ft	161 ft	184 ft	207 ft	230 ft		
38	112																		38	
40	112																		40	
45	109	102																	45	
50	106	98.5								92.5									50	
55	99	95	78							92	83								55	
60	89.5	91.5	76							90.5	82.5								60	
65	79	88.5	74	60						86.5	81.5	63.5							65	
70		81.5	73	59.1	48					83	79.5	63	49.3						70	
75			72	57.9	47.5						76.5	62.5	49.2						75	
80			70.5	56.8	46.6						73.5	62	49						80	
85			66.5	56.1	45.7	37.4					71.5	62	48.7	38.6					85	
90			58.7	55.6	44.9	36.8	29.3					61.5	48.4	38.4	30.3				90	
95			49.7	55.1	44.3	36.2	29.1					60.5	48.1	38.2	30.1				95	
100				53.9	43.8	35.7	28.8	22.8				58.6	48	38	30	23.5			100	
105				50.9	43.4	35.1	28.5	22.8					48	37.9	29.8	23.5			105	
110				45.9	42.8	34.8	28.1	22.6	14.9				47.9	37.8	29.7	23.4	18.7		110	
115				40.5	41.7	34.5	27.7	22.3	14.5				47.9	37.8	29.6	23.2	18.7		115	
120					40.4	34.3	27.4	21.9	13.9				47	37.8	29.5	23.1	18.6	12.9	120	
125						38.9	34.2	27.1	21.5	13.3				44.3	37.7	29.4	22.9	18.5	12.8	125
130						36.7	34	27	21	12.8				38.8	37.2	29.4	22.8	18.4	12.4	130
135						33.4	33.9	26.8	20.6	12.3					36.5	29.4	22.7	18.3	12	135
140						29.5	33.5	26.4	20.2	11.8					35.6	29.4	22.5	18.2	11.5	140
145							32.4	26	19.8	11.3					34.6	29.4	22.3	18.1	11.1	145
150							30.1	25.6	19.3	10.8					32.1	29.4	22	17.9	10.7	150
155							27.4	25.2	18.9	10.4						29.4	21.7	17.7	10.4	155
160							24.6	24.8	18.5	9.9						29.4	21.5	17.5	10	160
165								24.4	18.1	9.5						29	21.2	17.2	9.6	165
170								23.9	17.7	9.1						26.7	20.9	16.9	9.2	170
175								22.3	17.3	8.7						23.6	20.7	16.6	8.8	175
180								20.4	16.9	8.3							20.5	16.4	8.5	180
185								18.2	16.6	7.9							20.5	16.1	8.1	185
190								15.6	16.3	7.5							20.4	15.8	7.7	190
195									16	7.1							20	15.6	7.4	195
200									15.8	6.8								15.3	7.1	200
205									15.2	6.4								15.2	6.8	205
210										6.2								15	6.4	210
215										5.9								14.8	6.2	215
220										5.7								14.1	5.9	220
225										5.5									5.7	225
230										5.3									5.5	230
235										5.2									5.3	235
240																			5.1	240
I						0									46					I
II						0									46					II
III						0									0					III
IV						0									0					IV
% V						0									0					V

* adapter / pièce d'adaptateur

TAB 131219.1/2

La LTM 1250/1 possède l'équipement qui convient à chaque problème.

Lifting capacities on the luffing lattice jib. Forces de levage à la fléchette treillis relevable.

LTM 1250/1



75°
119 ft - 221 ft



57 ft - 207 ft



360°



214900 lbs

85%

ft	119 ft + 10 ft*								153 ft + 10 ft*						ft	
	57 ft	69 ft	92 ft	115 ft	138 ft	161 ft	184 ft	207 ft	57 ft	69 ft	92 ft	115 ft	138 ft	161 ft		184 ft
60	63															60
65	63	55.9														65
70	60.5	55.9							39.3							70
75	58.3	55.2	43.4						39.1	34.4						75
80		53.8	43.4						38.8	34.4						80
85		51.7	43.3	34.5					38.1	34.4						85
90		49.8	43.2	34.4					37.2	34.2	26.8					90
95			43.1	34.3	27.4					33.7	26.7	20.6				95
100			42.7	34.3	27.4	21.8				33	26.7	20.6				100
105			41.5	34.2	27.3	21.8					26.7	20.6				105
110			40.4	34.2	27.3	21.7					26.6	20.5	16.3			110
115			39.6	34.2	27.2	21.7	17.2				26.4	20.5	16.3	11.9		115
120				34.1	27.2	21.6	17.2	13.1			26.1	20.5	16.3	11.9		120
125				33.8	27.2	21.5	17.2	13.1				20.5	16.3	11.9		125
130				33	27.2	21.5	17.1	13.1				20.5	16.2	11.9	8	130
135				32.5	27.2	21.4	17.1	13.1				20.5	16.2	11.9	8	135
140					27.2	21.4	17.1	13.1				20.5	16.2	11.9	8	140
145					27.2	21.4	17	13.1					16.2	11.9	8	145
150					27.2	21.4	17	13.1					16.2	11.9	8	150
155					27	21.4	17	13.1					16.2	11.9	8	155
160					26.7	21.4	17	13.1					16.2	11.9	8	160
165						21.4	17	13.1					16.2	11.9	8	165
170						21.4	17	13.1					16.2	11.9	8	170
175						21.4	17	13.1					11.9	8		175
180						21.4	17	13.1					11.9	8		180
185							17	13.1					11.9	8		185
190							17	13.1					11.9	8		190
195							17	13.1						8		195
200							17	13.1						8		200
205							17	13.1						8		205
210								13.1						8		210
215								13.1						8		215
220								13.1								220
225								13.1								225
I				92							92					I
II				46							46					II
III				46							46					III
IV				0							46					IV
V				0							46					V

* adapter / pièce d'adaptateur

TAB 131219.3

ft	187 ft + 10 ft*					204 ft + 10 ft*				221 ft + 10 ft*			ft
	57 ft	69 ft	92 ft	115 ft	138 ft	57 ft	69 ft	92 ft	115 ft	57 ft	69 ft	92 ft	
90	22.8	20.4											90
95	22.5	20.3				17.1	14.8						95
100		20.1	15.5			16.9	14.8			11.6			100
105		19.8	15.5				14.8			11.6			105
110		19.4	15.5	10.9			14.6	9.9		11.6	9.5		110
115			15.4	10.9			14.4	9.9			9.5	5.3	115
120			15.4	10.9	7			9.9	6.1			5.3	120
125			15.2	10.9	7			9.9	6.1			5.3	125
130			15	10.9	7			9.9	6.1			5.3	130
135				10.9	7			9.9	6.1			5.3	135
140				10.9	7				6.1			5.3	140
145				10.9	7				6.1				145
150				10.9	7				6.1				150
155				10.9	7				6.1				155
160					7								160
175					7								175
I				92				92			92		I
II				92				92			92		II
III				92				92			92		III
IV				46				92			92		IV
V				46				46			92		V

* adapter / pièce d'adaptateur

TAB 131219.4

Lifting heights. Hauteurs de levage.

LTM 1250/1

Luffing lattice jib.
Fléchette treillis relevable.

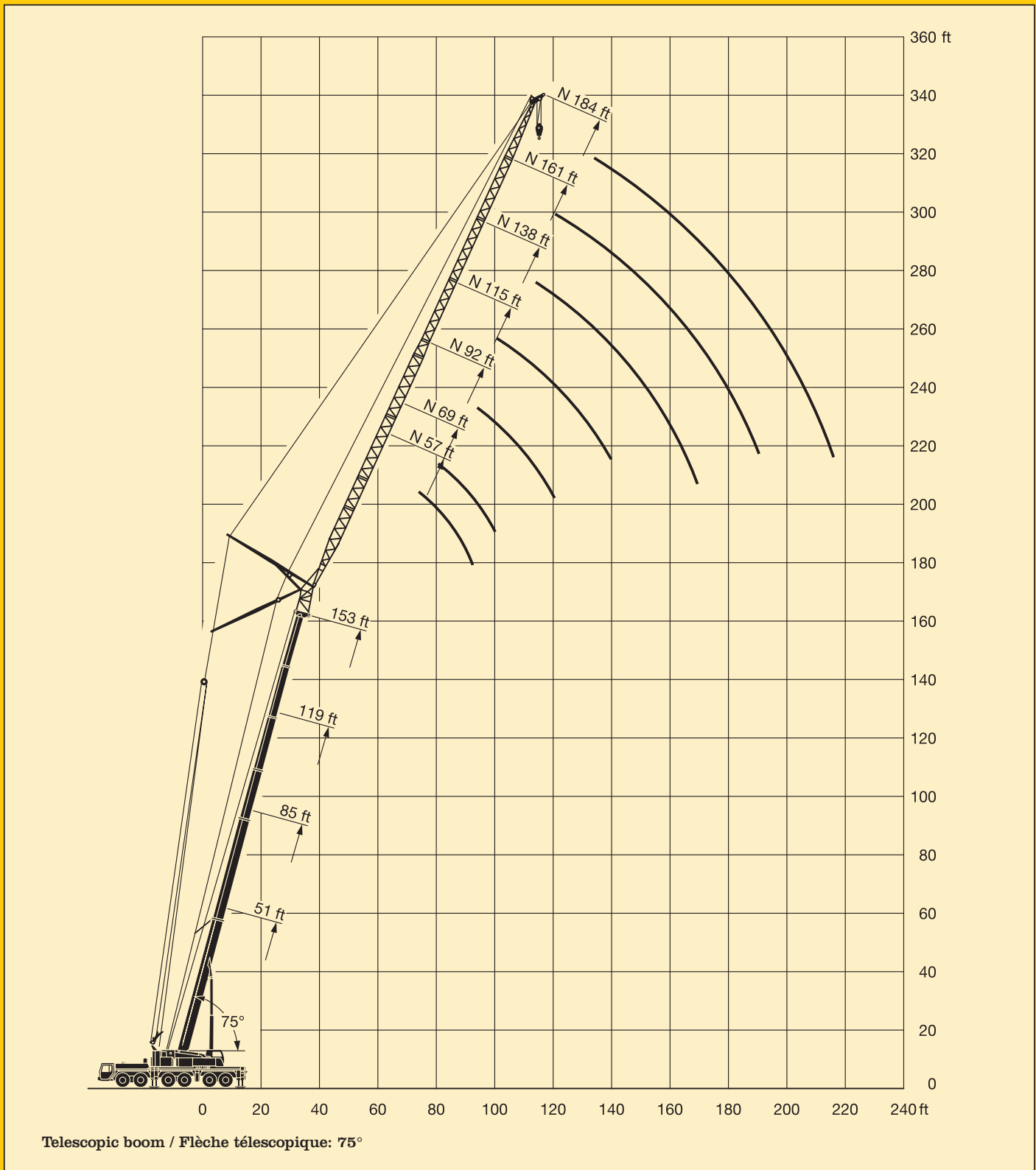

Lifting capacities on the luffing lattice jib. Forces de levage à la fléchette treillis relevable.

LTM 1250/1



68°
51 ft – 85 ft



57 ft – 230 ft



360°



214900 lbs

85%

ft	51 ft + 10 ft*										85 ft + 10 ft*										ft
	57 ft	69 ft	92 ft	115 ft	138 ft	161 ft	184 ft	207 ft	230 ft	57 ft	69 ft	92 ft	115 ft	138 ft	161 ft	184 ft	207 ft	230 ft			
55	93.5																		55		
60	92.5	89																	60		
65	89	84								81									65		
70	82.5	81								77									70		
75		78.5	69.5							73	72								75		
80		74	67.5							69.5	68								80		
85		62	66	54.9						66.5	64.5	60							85		
90			65	53.9							62	58.6							90		
95			62.5	52.9	43.2							56.6	46.8						95		
100			57.6	52.2	43							54.5	46.6						100		
105				51.8	42.2	35						52.6	46.1						105		
110				51.5	41.5	34.4						50.8	45.7	37					110		
115				49.5	41	33.8	27.4					49.4	45.2	36.8					115		
120				45.9	40.7	33.3	27.3						44.4	36.5	28.9				120		
125					40.4	32.8	26.9						43.3	36.2	28.9				125		
130					39.3	32.6	26.5	21.4					42	36.1	28.8				130		
135					38	32.5	26.2	21.1					41	36	28.7	22.4			135		
140					36.3	32.5	25.9	20.7	12					36	28.6	22.4	17.8		140		
145					33.8	32.5	25.7	20.4	11.9					35.9	28.5	22.4	17.8		145		
150					30.3	32.5	25.7	20	11.4					35.2	28.5	22.4	17.8		150		
155						31.9	25.5	19.5	11					34.6	28.5	22.2	17.8	11	155		
160						30.4	25.2	19.1	10.5					33.5	28.5	22	17.8	10.8	160		
165						28.1	24.9	18.7	10.1						28.5	21.8	17.7	10.4	165		
170						25.4	24.6	18.3	9.7						28.5	21.5	17.5	10	170		
175							24.3	17.9	9.3						28.5	21.2	17.3	9.6	175		
180							23.8	17.5	8.8						28	21	17	9.3	180		
185							22.9	17.1	8.5							20.8	16.7	8.9	185		
190							21.2	16.8	8.1							20.5	16.4	8.6	190		
195							18.8	16.4	7.7							20.4	16.1	8.2	195		
200								16.1	7.3							20.3	15.9	7.9	200		
205								15.8	7							20.3	15.6	7.5	205		
210								15.6	6.6								15.3	7.2	210		
215								15.4	6.3								15.1	6.9	215		
220									6								14.9	6.6	220		
225									5.7								14.8	6.2	225		
230									5.5									6	230		
235									5.4									5.7	235		
240									5.2									5.5	240		
245																		5.3	245		
250																		5.2	250		
255																		5.1	255		
I	0										46										I
II	0										46										II
III	0										0										III
IV	0										0										IV
V	0										0										V

* adapter / pièce d'adaptateur

TAB 131222.1/2

Lifting capacities on the luffing lattice jib. Forces de levage à la fléchette treillis relevable.

LTM 1250/1



68°
119 ft – 221 ft



57 ft – 207 ft



360°



21490 lbs

85%

ft	119 ft + 10 ft*								153 ft + 10 ft*						ft	
	57 ft	69 ft	92 ft	115 ft	138 ft	161 ft	184 ft	207 ft	57 ft	69 ft	92 ft	115 ft	138 ft	161 ft		184 ft
85	48.4															85
90	46.2	44.6														90
95	44.2	43.3							31.9							95
100		41.4	37.7						31.4	29.1						100
105			37.7						30.1	29.1						105
110			36.3						28.9	28						110
115			35	32						26.9	23.7					115
120			33.8	31.6	26.7						23.5					120
125			32.6	30.5	26.7						22.8					125
130			31.6	29.6	26.6						22.2	19.2				130
135				28.6	26.2	21					21.5	18.9				135
140				27.8	25.6	21					20.8	18.4	15.3			140
145				26.9	24.9	21						18	15.3			145
150				26.1	24.2	21	16.7					17.6	15.2			150
155					23.6	21	16.7					17.2	15	10.9		155
160					23	20.9	16.7	12.6				16.8	14.8	10.9		160
165					22.4	20.7	16.7	12.6					14.5	10.9		165
170					21.7	20.1	16.7	12.6					14.3	10.9	7.5	170
175					21.3	19.6	16.7	12.6					13.9	10.9	7.5	175
180						19.2	16.7	12.6					13.6	10.9	7.5	180
185						18.7	16.7	12.6					13.2	10.9	7.5	185
190						18.2	16.5	12.6					12.9	10.9	7.5	190
195						17.9	16.1	12.6						10.9	7.5	195
200							15.8	12.6						10.7	7.5	200
205							15.4	12.6						10.4	7.5	205
210							15.1	12.6							7.5	210
215							14.8	12.6							7.5	215
220							14.6	12.6							7.5	220
225								12.5							7.5	225
230								12.2							7.5	230
235								12							7.5	235
240								11.8								240
I				92								92				I
II				46								46				II
III				46								46				III
IV				0								46				IV
V				0								46				V

* adapter / pièce d'adaptateur

TAB 131222.3

ft	187 ft + 10 ft*					204 ft + 10 ft*		221 ft + 10 ft*	ft
	57 ft	69 ft	92 ft	115 ft	138 ft	92 ft	115 ft	92 ft	
115	17								115
120	16.7								120
125		15.1							125
130		14.6							130
135			11.9						135
140			11.7						140
145			11.3						145
150			11	9					150
155			10.6	8.7					155
160				8.5	6.3			4.4	160
165				8.2	6.3			4.4	165
170				7.9	6.3			4.4	170
175				7.7	6.1				175
180					6				180
185					5.8				185
190					5.7				190
195					5.5				195
200					5.4				200
I			92				92	92	I
II			92				92	92	II
III			92				92	92	III
IV			46				92	92	IV
V			46				46	92	V

* adapter / pièce d'adaptateur

TAB 131222.4

Lifting heights. Hauteurs de levage.

LTM 1250/1

Luffing lattice jib.
Fléchette treillis relevable.

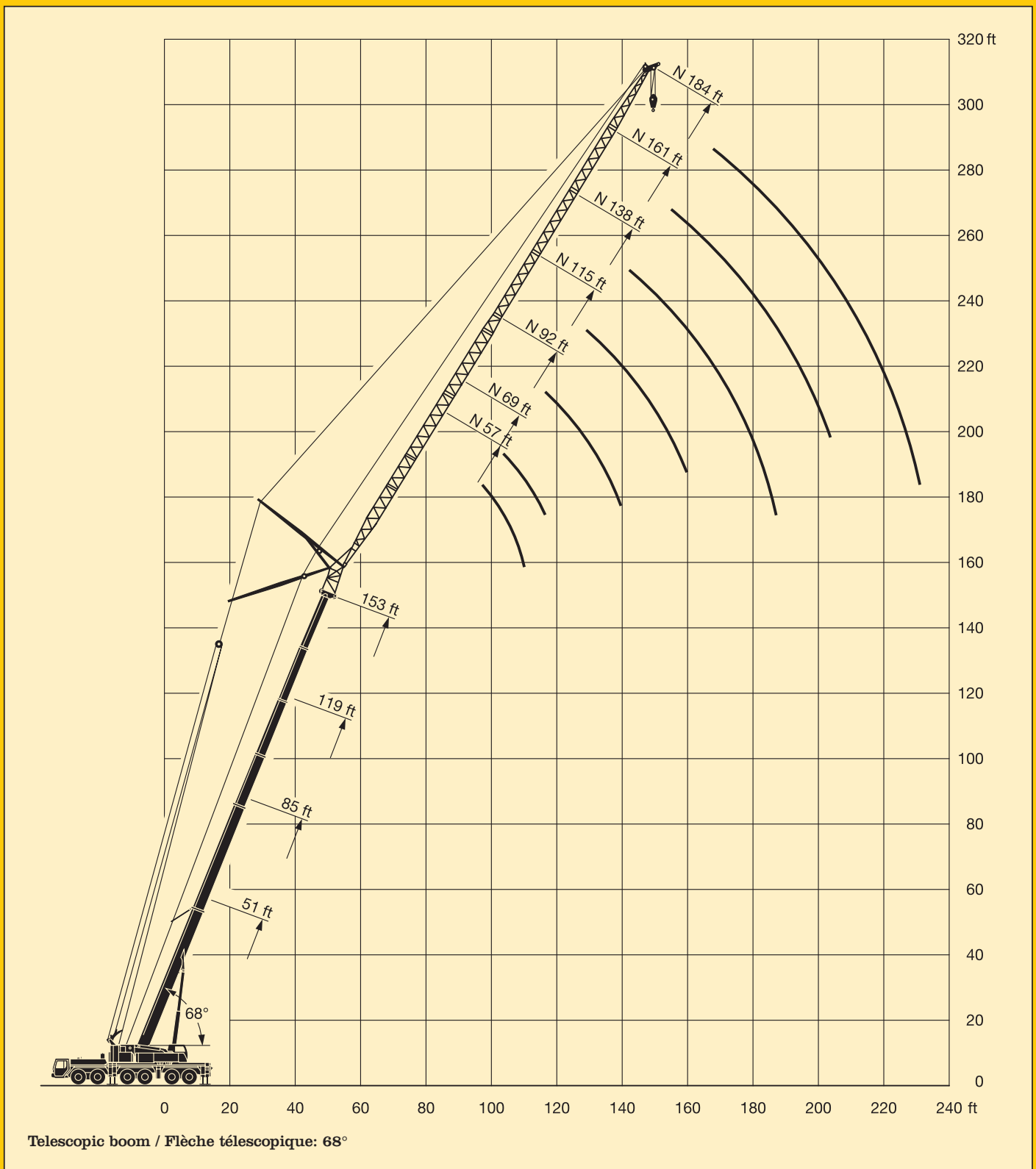

Dimensions. Encombrement.

LTM 1250/1

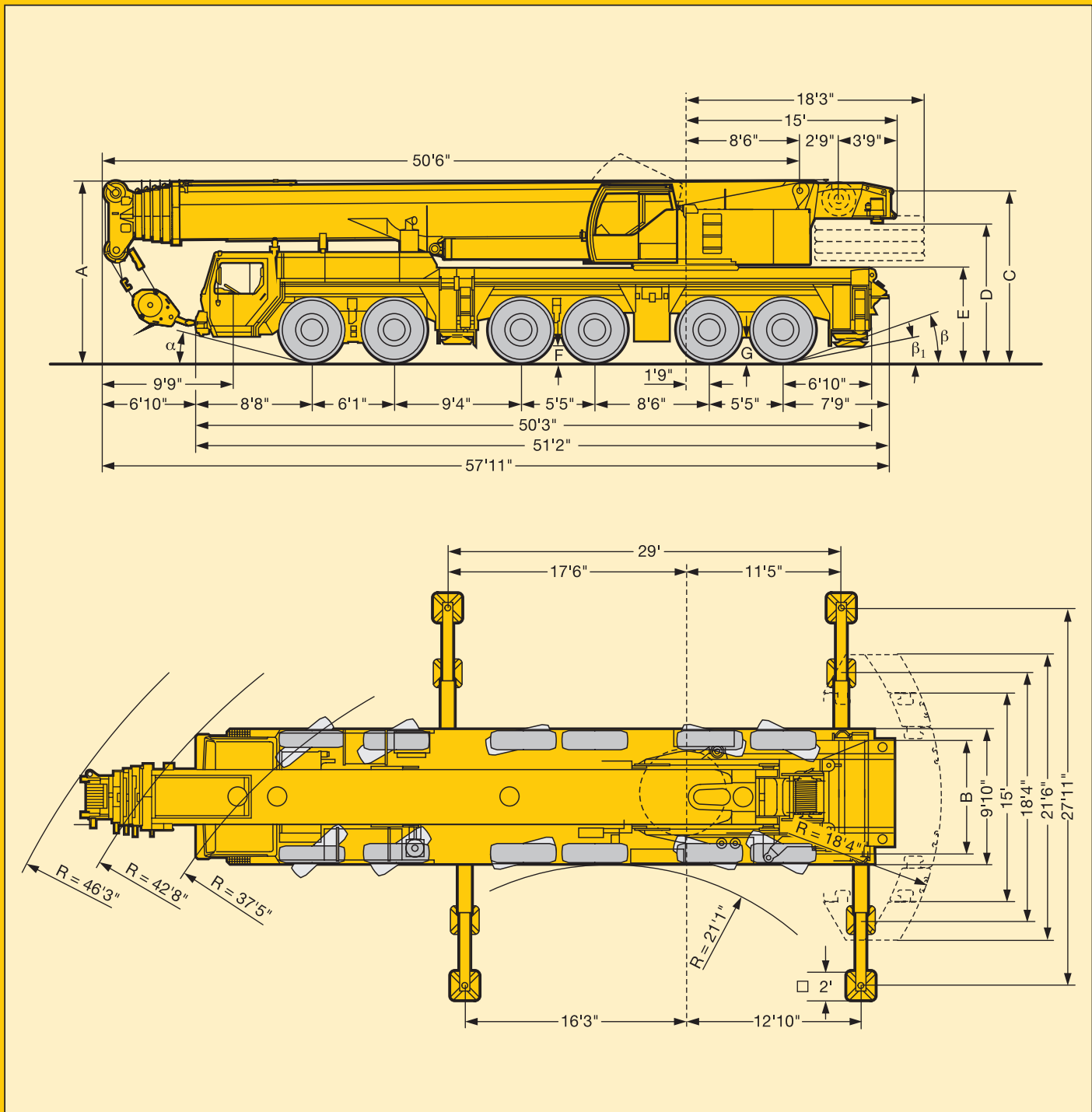

 16.00 R 25	A	A	B	C	Dimensions / Encombrement				α	β	β_1
		150 mm*				E	F	G			
	13'1"	12'8"	8'4"	12'4"	10'	6'9"	1'3"	1'6"	17°	19°	13°

* lowered / abaissé



Axle Essieu	1	2	3	4	5	6	Total weight (lbs) Poids total lbs
t	26432	26432	26432	26432	26432	26432	158590



Load (kips) ¹⁾ Forces de levage kips ¹⁾	No. of sheaves Poulies	No. of lines Brins	Weight lbs Poids lbs
385	9	18	4400
313	7	14	3300
238	5	10	3190
154	3	6	2290
68	1	3	1920
22	-	1	1100

¹⁾ The safety regulations of the respective country shall be applicable.
Les spécifications de sécurité du pays concerné seront en vigueur.

Working speeds. Vitesses.



	1	2	3	4	5	R	
	9.3	14.9	23	34.2	47.2	8.7	-
	5	8.7	13.7	19.9	27.3	4.7	39 %
	16.00 R 25						



Drive Mécanismes	infinitely variable en continu	Rope diameter / Rope length Diamètre du câble / Longueur du câble	Max. single line pull Effort au brin maxi.
	0 - 443 ft/min single line ft/min au brin simple	1" / 1181'	23605 lbs
	0 - 443 ft/min single line ft/min au brin simple	1" / 1394'	23605 lbs
	0 - 1,6 min ⁻¹		
	approx. 60 seconds to reach 82° boom angle env. 60 s jusqu'à 82°		
	approx. 450 seconds for boom extension from 51 ft - 236 ft env. 450 s pour passer de 51 ft - 236 ft		

Crane carrier.

LTM 1250/1

Frame:	Liebherr designed and manufactured, box-type, torsion resistant design of high-tensile fine grained structural steel.
Outriggers:	Four hydraulically extendable sliding beams with hydraulic jacks and supporting pads. The front outrigger casing is mounted between axles 2 and 3 and the rear casing is located at the rear of the carrier.
Engine:	8-cylinder Diesel engine, make Liebherr, type D 9408 TI-E, watercooled, output acc. to DIN 440 kW (598 HP) at 1900 min ⁻¹ acc. to ECE 24.03 and 1999/96 EG (Euro 3), max. torque 1915 lbs-ft at 1400 min ⁻¹ . Fuel tank: 158 gallons.
Transmission:	Automatic transmission, make Allison, type CLBT 755, with torque converter and hydrodynamic brake, 5 forward speeds, 1 reverse. Two stage transfer case with transfer differential and off-road ratio.
Axles:	Crane carrier axles of minor maintenance. All axles suspended. Axles 1 to 3 and 5 and 6 steered. Axles 1, 5 and 6 are planetary axles, intermediate differential at axle 5, all driven axles with transverse differential locks.
Cardan shaft:	All cardan shafts with 70° diagonal toothing and maintenance-free.
Suspension:	All axles with hydropneumatic suspension and automatic levelling system. Load equalization between the axle pairs 1 + 2, 3 + 4 and 5 + 6. The suspension can be locked hydraulically.
Tyre equipment:	12 tyres, all axles equipped with single tyres. Size of tyres: 16.00 R 25.
Steering:	ZF semi-integral power steering, dual circuit system with hydraulic servo-system and additional backing pump driven by an axle.
Brakes:	Service brake: All-wheel servo-air brake, dual circuit system. Supplementary brakes: Exhaust brake with Liebherr supplementary brake system, retarder in the automatic transmission. Hand brake: Spring-loaded, acting on all wheels of axles 2 to 6.
Driving cab:	Spacious sheet steel cab, cataphoretic dip-primed, mounted on rubber shock absorbers, safety glass windows, operating and control elements.
Electrical system:	Modern data bus technique for the control of the electric and electronic components. 24 Volt DC, 2 batteries of 170 Ah each, lighting according to traffic regulations.

Crane superstructure.

Frame:	Liebherr-made torsion resistant, welded construction of high-tensile structural steel, linked to carrier by a roller slewing rim for 360° continuous rotation.
Crane engine:	4-cylinder Diesel engine, make Liebherr, type D 924 TI-E, watercooled, output acc. to DIN 180 kW (245 HP) at 1800 min ⁻¹ , max. torque 770 lbs-ft at 1150 min ⁻¹ . Fuel tank capacity: 79 gallons.
Crane drive:	Diesel-hydraulic, with 5 axial piston variable displacement pumps, with servo-control and capacity control.
Crane control:	Two self-centering control levers (joy-sticks). Electronic control by means of the LICCON system, infinitely variable crane motions through displacement control of the hydraulic pumps. Additional working speed control by variation of the Diesel engine speed.
Hoist gear:	Axial piston variable displacement motor, Liebherr hoist drum with integrated planetary gear and spring-loaded static brake.
Luffing gear:	1 differential hydraulic rams with nonreturn valve.
Slewing gear:	Hydraulic motor, planetary gear, slewing pinion and spring-loaded static brake.
Crane cab:	Galvanized steel construction, powder coating, safety glazing, operating and control elements. Cab tiltable backwards by 20°.
Safety devices:	LICCON safe load indicator, test system, hoist limit switches, safety valves against rupture of pipes and hoses.
Counterweight:	159800 lbs counterweight comprising 1 basic slab of 22000 lbs and 3 slabs of 27500 lbs each, 2 lateral hang on slabs of 27500 lbs each.
Telescopic boom:	1 base section and 5 telescopic sections. All telescopic sections extendable individually by means of the rapid-cycle telescoping system TELEMATIK. Boom length 51 ft to 236 ft.
Electric system:	Modern data bus technique for the control of the electric and electronic components, 24 Volt DC, 2 batteries of 170 Ah each.

Complementary equipment.

Folding jibs:	Single folding jib, 40 ft long, for mounting on telescopic boom at 0°, 20° or 40°. Double folding jib, 40 ft to 72 ft long, for mounting on telescopic boom at 0°, 20° or 40°.
Intermediate sections:	2 intermediate sections of 23 ft each for the extension of the biparted swing-away jib to 95 ft or 118 ft.
Lattice jibs:	Fixed lattice jib 46 ft to 138 ft long, installation at 0°, 20° or 40°, luffing lattice jib 57 ft to 230 ft long.
2nd hoist gear:	For 2-hook operation or for operating the luffing lattice jib.
Additional counterweight:	2 additional lateral hang on slabs of 27500 lbs each for a total counterweight of 214900 lbs.
Drive 12 x 8:	Axle 3 additionally driven.
TELMA-type eddy current brake:	Fitted to the 4 th axle for increasing the sustained-action braking performance.

Further equipment available on request.

Châssis porteur.

LTM 1250/1

Châssis:	Fabrication Liebherr, construction en caisson indéformable, en acier à haute résistance à grains fins.
Stabilisateurs:	Quatre poutres horizontales télescopiques, avec vérins hydrauliques de calage verticaux et patins. Les caissons de poutres de calage avants sont situés entre les essieux 2 et 3, et les caissons des poutres de calage arrières sont situés à l'arrière du châssis.
Moteur:	Diesel 8 cylindres, marque Liebherr, type D 9408 TI-E, refroidi par eau, puissance selon DIN 440 kw (598 ch) à 1900 min ⁻¹ selon ECE 24.03 et 1999/96 EG (Euro 3), couple max. 1915 lbs-ft à 1400 min ⁻¹ . Réservoir à carburant: 158 gallons.
Boîte de vitesse:	Boîte automatique de marque Allison, type CLBT 755, avec convertisseur de couple et ralentisseur hydraulique intégré. Cinq rapports avants et 1 rapport arrière. Boîte de transfert à 2 rapports avec blocage de différentiel et étage vitesses terrain.
Essieux:	Essieux de la grue exempts d'entretien, les 6 essieux sont suspendus. Les essieux 1 à 3, 5 et 6 sont directs. Les essieux 1, 5 et 6 sont des essieux planétaires, entraînés, différentiel intermédiaire à l'essieu 5, tous les essieux moteurs sont munis de dispositifs de blocage du différentiel transversal.
Arbres articulés:	Tous les arbres articulés à denture étagée de 70° et exempts d'entretien.
Suspension:	Tous les essieux sont suspendus hydropneumatiquement avec mise à niveau et équilibrage entre essieux automatiques. Egalisation de la charge par essieu entre essieux 1 + 2, 3 + 4 et 5 + 6. Suspension blocable hydrauliquement.
Pneumatiques:	12 roues à monte simple. Taille: 16.00 R 25
Direction:	Direction semi-bloc ZF, à double circuit, assistée hydrauliquement, avec pompe auxiliaire entraînée par un essieu.
Freins:	Frein de service: à double circuit assisté pneumatiquement, sur toutes les roues. Freins supplémentaires: frein à clapet d'échappement avec système de freinage supplémentaire Liebherr, ralentisseur dans la boîte automatique. Frein de secours et frein à main: par cylindres à ressorts sur les essieux 2 à 6.
Cabine:	Cabine spacieuse, tôle d'acier, revêtue anti-corrosion par bain de cathorèse, suspendue sur silent blocs, vitrage de sécurité, tableau de bord complet.
Installation électrique:	Technologie de bus de données moderne pour la commande des composants électriques et électroniques, courant continu 24 Volts, 2 batteries de 170 Ah chacune, éclairage conforme au code de la route.

Partie tournante.

Châssis:	Construction mécanosoudée en tôle d'acier à haute résistance à grains fins. Reliée au porteur par une couronne d'orientation à 3 rangées de rouleaux. Rotation totale 360°.
Moteur:	Diesel 4 cylindres, marque Liebherr, type D 924 TI-E, refroidi par eau, puissance DIN 180 kw (245 ch) à 1800 min ⁻¹ , couple max. 770 lbs-ft à 1150 min ⁻¹ . Réservoir à carburant: 79 gallons.
Entraînement:	Diesel hydraulique à 3 pompes à débit variable servo commandées à régulation de puissance.
Commande:	2 leviers à 4 directions avec rappel automatique au point mort. Commande électronique via le dispositif LICCON. Commande des mouvements progressive en continu par variation de l'inclinaison des pompes et augmentation du régime moteur.
Treuil:	Moteur hydraulique à cylindrée variable, treuil de marque Liebherr avec réducteur planétaire à frein d'arrêt à lamelles intégrées.
Relevage de flèche:	1 vérin hydraulique différentiel avec clapet anti-retour de sécurité.
Orientation:	Un moteur hydraulique, un réducteur planétaire, un pignon d'orientation et un frein à lamelles.
Cabine de grue:	En tôle d'acier galvanisée, peinte par poudrage polyester et cuisson au four, avec vitrage de sécurité, dotées de tous les éléments de contrôle et de commande, cabine inclinable vers l'arrière de 20°.
Sécurité:	Contrôleur de charge LICCON, système test, fin de course crochet haut, clapets de sécurité en cas de ruptures de flexibles.
Contrepoids:	159800 lbs, composé d'une plaque de base de 22000 lbs et 3 plaques de 27500 lbs unitaires, 2 blocs latéraux de suspension de 27500 lbs.
Flèche télescopique:	Un élément de base et de 5 télescopes. Chaque partie peut être télescopée individuellement à l'aide du système de télescope séquentiel rapide TELEMATIK. Longueur de flèche: 51 ft - 236 ft.
Circuit électrique:	Technologie de bus de données moderne pour la commande des composants électriques et électroniques, courant continu 24 Volts, 2 batteries de 170 Ah chacune.

Équipement optionnel.

Fléchettes pliante:	Fléchette pliante, 40 ft, pour le montage à la flèche télescopique à 0°, 20° ou 40°. Fléchette pliante double, 40 ft à 72 ft, pour montage à la flèche télescopique à 0°, 20° ou 40°.
Éléments intermédiaires:	2 éléments intermédiaires de 23 ft de long pour l'allongement de la fléchette pliante double jusqu'à 95 ft resp. 118 ft.
Fléchettes:	Fléchette fixe de 46 ft à 138 ft; montable à 0°, 20° ou 40° fléchette à volée variable de 57 ft à 230 ft.
Deuxième treuil:	Pour le travail avec 2 crochets ou le relevage de la fléchette à volée variable.
Contrepoids complémentaire:	2 blocs latéraux de suspension de 27500 lbs pour un contrepoids total de 214900 lbs.
Entraînement 12 x 8:	3ème essieu est entraîné additionnellement.
Frein Telma:	Monté sur le 4ème essieu pour augmenter la puissance de freinage continu.

Autres équipement supplémentaires sur demande.

Subject to modification. / Sous réserve de modifications.

TP 314a US.6.02

Please contact

Veillez prendre contact avec

LIEBHERR-WERK EHINGEN GMBH

D-89582 Ehingen/Donau, Telefon (0 73 91) 5 02-0, Telefax (0 73 91) 5 02-33 99

www.lwe.liebherr.de, E-mail: info@lwe.liebherr.com

CD-