

Operating Range Diagram

777T

Carrier on Fully Extended Outriggers

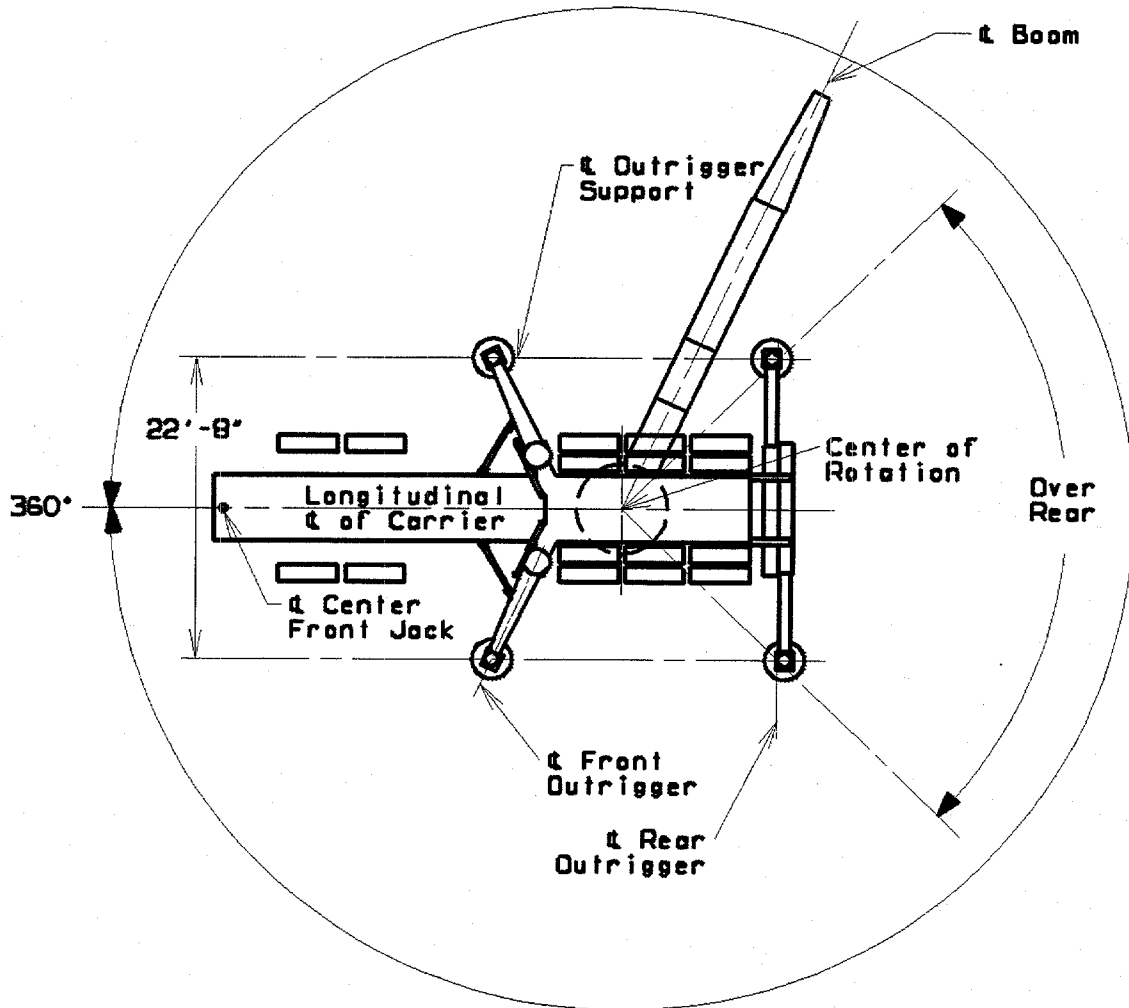

These lines determine limiting position of any load for operation within working areas indicated.

Approved working areas for truck crane on fully extended outriggers are shown in above diagram. Center front jack must be used at all times when operating on outriggers.

Lifting is approved only in those areas for which ratings are shown on capacity charts.

S/N: 7779006

Manitowoc Cranes, Inc.

Manitowoc, Wisconsin 54220 U.S.A.



Liftcrane Boom Capacities

Boom No. 78T With Heavy Lift Top
0 Lb. to 95,400 Lb. Crane Counterweight
With or Without 25,000 Lb. Front Bumper Counterweight
Rating Over Rear or 360 Degrees On Fully Extended Outriggers

Meets
ANSI B30.5
Requirements

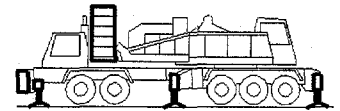

LIFTING CAPACITIES: Lifting capacities for various boom lengths and operating radii are for freely suspended loads and do not exceed 85% of a static tipping load. Capacities based on structural competence are denoted by an asterisk (*).

Upper boom point capacity for liftcrane service with single part whip line is 29,500 Lbs. or 59,000 Lbs. with two part whip line. When boom butt mounted auxiliary drum is used, capacity with single part whip line is 20,000 Lbs. or 40,000 Lbs. with two part whip line. In all cases, upper boom point capacities cannot exceed those listed for main boom capacity.

Weight of jib, all load blocks, hooks, weight ball, slings, hoist lines, etc., beneath boom and jib point sheaves, is considered part of main boom load. Boom is not to be lowered beyond radii where combined weights are greater than rated capacity. Where no capacity is shown, operation is not intended or approved.

OPERATING CONDITIONS: Machine to operate in a level position on a firm uniformly supporting surface with outriggers fully extended (22 Ft. 8 in.) and set. Refer to operators manual for outrigger positioning. Radii less than 32 Ft. not recommended when lifting over front of truck. Minimum boom angle over truck cab is 24 degrees.

Note: Set four main jacks first, then lower center front jack until it just contacts ground to prevent preloading of center front jack. Center front jack must be used when operating on outriggers.

Refer to boom rigging **No. 192043**, Wire Rope Specification chart **No. 7973-A** and Operating Range Diagram chart **No. 7974-A**. Crane operator judgment must be used to allow for dynamic load effects of swinging, hoisting or lowering, wind conditions, as well as adverse operating conditions and physical machine depreciation. Refer to operators manual for operating guidelines.

OPERATING RADIUS: Operating radius is horizontal distance from axis of rotation to center of vertical hoist line or load block. Boom angle is angle between horizontal and centerline of boom butt and inserts, and is an indication of operating radius. In all cases, operating radius shall govern capacity.

BOOM POINT ELEVATION: Boom point elevation is vertical distance from ground level to centerline of boom point shaft.

MACHINE EQUIPMENT: Machine equipped with Manitowoc 10 x 6 carrier, 277 in. wheel base, 117 in. front axle track, 100 in. rear axle track, 14.00 x 24 tires, 96 in. front outriggers, 70 in. rear outriggers, two 12 in. boom hoist cylinders, 26 Ft. mast, two boom support straps, crane counterweight as specified and with or without 25,000 Lb. front bumper counterweight.

Deduct From Capacities When Jib Is Attached	
Jib Length	Jib No. 134
30 Ft.	3,900 Lbs.
40 Ft.	4,700 Lbs.
50 Ft.	5,600 Lbs.
60 Ft.	6,600 Lbs.
70 Ft.	7,600 Lbs.
80 Ft.	8,700 Lbs.

Upper Boom Point Deduct
Deduct 1,000 Lbs. from capacities when upper boom point is attached.

Auxiliary Drum Deduct
Deduct 1,700 Lbs. from capacities when boom butt is equipped with auxiliary drum.

Manitowoc Cranes, Inc.

Manitowoc, Wisconsin 54220 U.S.A.



Liftcrane Boom Capacities

Meets
ANSI B30.5
Requirements

Boom No. 78T With Heavy Lift Top
0 Lb. to 95,400 Lb. Crane Counterweight
With or Without 25,000 Lb. Front Bumper Counterweight
Rating Over Rear or 360 Degrees On Fully Extended Outriggers

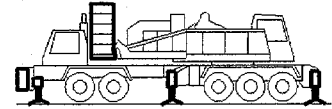

Maximum Boom and Jib Lengths Lifted Unassisted On Outriggers						
Over Rear of Outriggers		Over Side of Fully Extended Outriggers		Over Side of Partially Extended Outriggers		Over Side of Fully Retracted Outriggers
Boom Length	Jib No. 134	Boom Length	Jib No. 134	Boom Length	Jib No. 134	Boom Length
95,400 Lb. Crane Counterweight + 25,000 Lb. Front Bumper Ctw.						
(a) 270 Ft.	---	220 Ft.	---			
(b) 260 Ft.	---	210 Ft.	---			
250 Ft.	---	200 Ft.	30 Ft.	Not Allowed		Not Allowed
240 Ft.	30 Ft.	190 Ft.	60 Ft.			
230 Ft.	50 Ft.	180 Ft.	80 Ft.			
220 Ft.	80 Ft.					
95,400 Lb. Crane Counterweight						
(c) 240 Ft.	---	220 Ft.	---			
230 Ft.	---	210 Ft.	---			
210 Ft.	40 Ft.	200 Ft.	30 Ft.	Not Allowed		Not Allowed
200 Ft.	70 Ft.	190 Ft.	60 Ft.			
190 Ft.	80 Ft.	180 Ft.	80 Ft.			
78,400 Lb. Crane Counterweight						
220 Ft.	---	200 Ft.	---	180 Ft.	---	
210 Ft.	---	190 Ft.	---	170 Ft.	---	
200 Ft.	30 Ft.	180 Ft.	50 Ft.	160 Ft.	40 Ft.	Not Allowed
190 Ft.	60 Ft.	170 Ft.	70 Ft.	150 Ft.	70 Ft.	
180 Ft.	80 Ft.	160 Ft.	80 Ft.	140 Ft.	80 Ft.	
61,400 Lb. Crane Counterweight						
200 Ft.	---	180 Ft.	---	160 Ft.	---	
190 Ft.	---	170 Ft.	30 Ft.	150 Ft.	---	
180 Ft.	40 Ft.	160 Ft.	50 Ft.	140 Ft.	50 Ft.	Not Allowed
170 Ft.	70 Ft.	150 Ft.	70 Ft.	130 Ft.	80 Ft.	
160 Ft.	80 Ft.	140 Ft.	80 Ft.			
44,400 Lb. Crane Counterweight						
180 Ft.	---	160 Ft.	---	140 Ft.	---	
170 Ft.	---	150 Ft.	30 Ft.	130 Ft.	30 Ft.	
160 Ft.	40 Ft.	140 Ft.	60 Ft.	120 Ft.	60 Ft.	Not Allowed
150 Ft.	70 Ft.	130 Ft.	80 Ft.	110 Ft.	80 Ft.	
140 Ft.	80 Ft.					
Load block, hook and weight ball on ground at start. (a) Upper boom point and auxiliary drum cannot be used on 270 Ft. boom. (b) Upper boom point cannot be used on 260 Ft. boom over rear. (c) Upper boom point cannot be used on 240 Ft. boom over rear.						

Maximum Boom and Jib Lengths Lifted Unassisted On Rubber		
Over Rear		Over Side
Boom Length	Jib No. 134	Boom Length
95,400 Lb. Crane Counterweight + 25,000 Lb. Front Bumper Ctw.		
Not Allowed		
95,400 Lb. Crane Counterweight		
150 Ft.	---	
140 Ft.	---	
130 Ft.	40 Ft.	Not Allowed
120 Ft.	70 Ft.	
110 Ft.	80 Ft.	
78,400 Lb. Crane Counterweight		
130 Ft.	---	
120 Ft.	30 Ft.	
110 Ft.	50 Ft.	Not Allowed
100 Ft.	80 Ft.	
61,400 Lb. Crane Counterweight		
120 Ft.	---	
110 Ft.	---	
100 Ft.	40 Ft.	Not Allowed
44,400 Lb. Crane Counterweight		
100 Ft.	---	
Not Allowed		
Load block, hook and weight ball on ground at start.		

Manitowoc Cranes, Inc.

Manitowoc, Wisconsin 54220 U.S.A.



777T

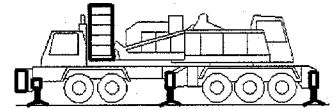

Liftcrane Boom Capacities

Boom No. 78T With Heavy Lift Top
 0 Lb. to 95,400 Lb. Crane Counterweight
 With or Without 25,000 Lb. Front Bumper Counterweight
 Rating Over Rear or 360 Degrees On Fully Extended Outriggers

Meets
 ANSI B30.5
 Requirements

Maximum Boom and Jib Lengths Lifted Unassisted On Outriggers						
Over Rear of Outriggers		Over Side of Fully Extended Outriggers		Over Side of Partially Extended Outriggers		Over Side of Fully Retracted Outriggers
Boom Length	Jib No. 134	Boom Length	Jib No. 134	Boom Length	Jib No. 134	Boom Length
27,400 Lb. Crane Counterweight						
160 Ft.	---	140 Ft.	---	120 Ft.	---	70 Ft.
150 Ft.	---	130 Ft.	30 Ft.	110 Ft.	---	
140 Ft.	50 Ft.	120 Ft.	60 Ft.	100 Ft.	50 Ft.	
130 Ft.	80 Ft.	110 Ft.	80 Ft.			
10,400 Lb. Crane Counterweight						
140 Ft.	---	120 Ft.	---	100 Ft.	---	42.5 Ft.
130 Ft.	---	110 Ft.	---			
120 Ft.	50 Ft.	100 Ft.	50 Ft.			
110 Ft.	70 Ft.					
100 Ft.	80 Ft.					
0 Lb. Crane Counterweight						
130 Ft.	---	100 Ft.	---	80 Ft.	---	Not Allowed
120 Ft.	---					
110 Ft.	40 Ft.					
100 Ft.	60 Ft.					
Load block, hook and weight ball on ground at start.						

Maximum Boom and Jib Lengths Lifted Unassisted On Rubber		
Over Rear		Over Side
Boom Length	Jib No. 134	Boom Length
27,400 Lb. Crane Counterweight		
80 Ft.	---	Not Allowed
10,400 Lb. Crane Counterweight		
60 Ft.	---	42.5 Ft.
0 Lb. Crane Counterweight		
42.5 Ft.	---	Not Allowed
Load block, hook and weight ball on ground at start.		

Consult jib chart for jib capacities. Upper boom point cannot be used when jib is attached.

Refer to chart No. 8095-A for partially extended outrigger boom capacities, chart No. 8096-A for fully retracted outrigger boom capacities, chart No. 8094-A for straight over rear on rubber boom capacities and chart No. 8094-B for over side sector on rubber boom capacities.

25 Ft. Boom¹



Oper. Rad. Feet	Boom Ang. Deg.	Boom Point Elev. Feet	95,400 Lb. Crane Cwt. 25,000 Lb. Bumper Cwt.
			Boom Capacity Rear - Pounds
11.0	82.1	33.3	440,000*

¹ Note: Requires additional rigging components.

S/N: 7779006

Manitowoc Cranes, Inc.

Manitowoc, Wisconsin 54220 U.S.A.



Liftcrane Boom Capacities

Meets
ANSI B30.5
Requirements

Boom No. 78T With Heavy Lift Top
0 Lb. to 95,400 Lb. Crane Counterweight
With or Without 25,000 Lb. Front Bumper Counterweight
Rating Over Rear or 360 Degrees On Fully Extended Outriggers

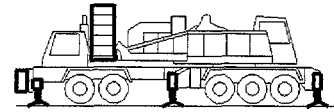

42.5 Ft. Boom



Oper. Rad. Feet	Boom Ang. Deg.	Boom Point Elev. Feet	95,400 Lb. Crane Cwt. 25,000 Lb. Bumper Cwt.		95,400 Lb. Crane Counterweight		78,400 Lb. Crane Counterweight		61,400 Lb. Crane Counterweight		Oper. Rad. Feet
			Boom Capacity 360 Deg. Pounds	Boom Capacity Rear Pounds	Boom Capacity 360 Deg. Pounds	Boom Capacity Rear Pounds	Boom Capacity 360 Deg. Pounds	Boom Capacity Rear Pounds	Boom Capacity 360 Deg. Pounds	Boom Capacity Rear Pounds	
12	81.6	50.3	364,000 *	364,000 *	364,000 *	364,000 *	364,000 *	364,000 *	364,000 *	364,000 *	12
13	80.2	50.1	364,000 *	364,000 *	364,000 *	364,000 *	364,000 *	364,000 *	348,400 *	348,400 *	13
14	78.8	49.8	354,900 *	354,900 *	354,900 *	354,900 *	340,000 *	340,000 *	325,100 *	325,100 *	14
15	77.4	49.6	332,600 *	332,600 *	332,600 *	332,600 *	318,600 *	318,600 *	304,600 *	304,600 *	15
16	76.0	49.3	312,800 *	312,800 *	312,800 *	312,800 *	299,600 *	299,600 *	286,400 *	286,400 *	16
17	74.6	48.9	295,200 *	295,200 *	295,200 *	295,200 *	282,700 *	282,700 *	270,200 *	270,200 *	17
18	73.1	48.6	279,400 *	279,400 *	279,400 *	279,400 *	267,500 *	267,500 *	255,700 *	255,700 *	18
19	71.7	48.2	265,100 *	265,100 *	265,100 *	265,100 *	253,800 *	253,800 *	242,500 *	242,500 *	19
20	70.2	47.8	252,100 *	252,100 *	252,100 *	252,100 *	241,400 *	241,400 *	230,600 *	230,600 *	20
22	67.2	46.9	229,500 *	229,500 *	229,500 *	229,500 *	219,700 *	219,700 *	208,600 *	208,600 *	22
24	64.1	45.8	210,400 *	210,400 *	210,400 *	210,400 *	200,900 *	200,900 *	189,100 *	189,100 *	24
26	61.0	44.6	194,100 *	194,100 *	194,100 *	194,100 *	183,500 *	183,500 *	172,700 *	172,700 *	26
28	57.7	43.3	178,800 *	178,800 *	178,800 *	178,800 *	168,800 *	168,800 *	158,800 *	158,800 *	28
30	54.2	41.8	165,400 *	165,400 *	165,400 *	165,400 *	156,100 *	156,100 *	146,800 *	146,800 *	30
32	50.6	40.0	153,700 *	153,700 *	153,700 *	153,700 *	145,000 *	145,000 *	131,200 *	136,300 *	32
34	46.8	38.1	143,400 *	143,400 *	143,400 *	143,400 *	135,200 *	135,200 *	118,200 *	127,100 *	34
36	42.7	35.8	134,300 *	134,300 *	134,300 *	134,300 *	124,800 *	126,600 *	107,300 *	118,900 *	36
38	38.2	33.2	126,100 *	126,100 *	126,100 *	126,100 *	114,200 *	118,800 *	98,000 *	111,600 *	38
40	33.1	30.0	118,800 *	118,800 *	118,800 *	118,800 *	105,000 *	111,900 *	90,000 *	105,000 *	40
45	12.7	16.0	98,100 *	98,100 *	98,100 *	98,100 *	86,400 *	96,900 *	73,600 *	86,300 *	45



Liftcrane Boom Capacities

Meets
ANSI B30.5
Requirements

Boom No. 78T With Heavy Lift Top
0 Lb. to 95,400 Lb. Crane Counterweight
With or Without 25,000 Lb. Front Bumper Counterweight
Rating Over Rear or 360 Degrees On Fully Extended Outriggers

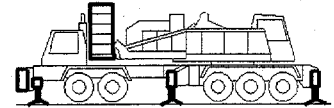

42.5 Ft. Boom



Oper. Rad. Feet	Boom Ang. Deg.	Boom Point Elev. Feet	44,400 Lb. Crane Counterweight		27,400 Lb. Crane Counterweight		10,400 Lb. Crane Counterweight		0 Lb. Crane Counterweight		Oper. Rad. Feet
			Boom Capacity 360 Deg. Pounds	Boom Capacity Rear Pounds	Boom Capacity 360 Deg. Pounds	Boom Capacity Rear Pounds	Boom Capacity 360 Deg. Pounds	Boom Capacity Rear Pounds	Boom Capacity 360 Deg. Pounds	Boom Capacity Rear Pounds	
12	81.6	50.3	358,100 *	358,100 *	341,000 *	341,000 *	323,800 *	323,800 *	313,400 *	313,400 *	12
13	80.2	50.1	332,500 *	332,500 *	316,500 *	316,500 *	300,600 *	300,600 *	290,900 *	290,900 *	13
14	78.8	49.8	310,200 *	310,200 *	295,300 *	295,300 *	280,300 *	280,300 *	271,300 *	271,300 *	14
15	77.4	49.6	290,600 *	290,600 *	276,600 *	276,600 *	262,600 *	262,600 *	251,200 *	251,200 *	15
16	76.0	49.3	273,200 *	273,200 *	260,000 *	260,000 *	244,400 *	244,400 *	233,300 *	233,300 *	16
17	74.6	48.9	257,700 *	257,700 *	245,000 *	245,000 *	228,000 *	228,000 *	217,700 *	217,700 *	17
18	73.1	48.6	243,800 *	243,800 *	229,600 *	229,600 *	213,600 *	213,600 *	203,900 *	203,900 *	18
19	71.7	48.2	231,000 *	231,000 *	216,000 *	216,000 *	200,900 *	200,900 *	175,800 *	191,700 *	19
20	70.2	47.8	218,000 *	218,000 *	203,700 *	203,700 *	184,100 *	189,500 *	153,900 *	180,800 *	20
22	67.2	46.9	195,700 *	195,700 *	182,800 *	182,800 *	147,000 *	169,900 *	122,400 *	162,100 *	22
24	64.1	45.8	177,300 *	177,300 *	155,500 *	165,600 *	121,500 *	153,800 *	100,800 *	134,400 *	24
26	61.0	44.6	161,600 *	161,900 *	132,300 *	151,100 *	103,000 *	132,100 *	85,100 *	113,900 *	26
28	57.7	43.3	140,500 *	148,800 *	114,700 *	138,800 *	88,900 *	114,300 *	73,100 *	98,300 *	28
30	54.2	41.8	123,800 *	137,500 *	100,800 *	123,700 *	77,700 *	100,300 *	63,700 *	86,100 *	30
32	50.6	40.0	110,400 *	127,600 *	89,600 *	110,200 *	68,700 *	89,100 *	56,100 *	76,200 *	32
34	46.8	38.1	99,300 *	118,200 *	80,300 *	99,000 *	61,300 *	79,800 *	49,700 *	68,000 *	34
36	42.7	35.8	89,900 *	107,200 *	72,500 *	89,600 *	55,000 *	71,900 *	44,400 *	61,200 *	36
38	38.2	33.2	81,900 *	97,900 *	65,800 *	81,600 *	49,700 *	65,300 *	39,800 *	55,300 *	38
40	33.1	30.0	75,000 *	89,800 *	60,000 *	74,600 *	45,000 *	59,500 *	35,800 *	50,200 *	40
45	12.7	16.0	60,800 *	73,400 *	48,100 *	60,400 *	35,300 *	47,500 *	27,500 *	39,700 *	45

Manitowoc Cranes, Inc.

Manitowoc, Wisconsin 54220 U.S.A.



777T

Liftcrane Boom Capacities

Meets
ANSI B30.5
Requirements

Boom No. 78T With Heavy Lift Top
0 Lb. to 95,400 Lb. Crane Counterweight
With or Without 25,000 Lb. Front Bumper Counterweight
Rating Over Rear or 360 Degrees On Fully Extended Outriggers

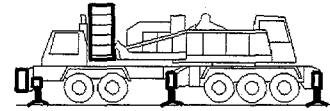

60 Ft. Boom



Oper. Rad. Feet	Boom Ang. Deg.	Boom Point Elev. Feet	95,400 Lb. Crane Cwt. 25,000 Lb. Bumper Cwt.		95,400 Lb. Crane Counterweight		78,400 Lb. Crane Counterweight		61,400 Lb. Crane Counterweight		Oper. Rad. Feet
			Boom Capacity 360 Deg. Pounds	Boom Capacity Rear Pounds	Boom Capacity 360 Deg. Pounds	Boom Capacity Rear Pounds	Boom Capacity 360 Deg. Pounds	Boom Capacity Rear Pounds	Boom Capacity 360 Deg. Pounds	Boom Capacity Rear Pounds	
13	83.2	68.4	364,000 *	364,000 *							13
14	82.2	68.2	353,700 *	353,700 *	353,700 *	353,700 *	338,900 *	338,900 *	324,000 *	324,000 *	14
15	81.3	68.0	331,600 *	331,600 *	331,600 *	331,600 *	317,600 *	317,600 *	303,500 *	303,500 *	15
16	80.3	67.8	311,800 *	311,800 *	311,800 *	311,800 *	298,600 *	298,600 *	285,400 *	285,400 *	16
17	79.3	67.6	294,300 *	294,300 *	294,300 *	294,300 *	281,800 *	281,800 *	269,300 *	269,300 *	17
18	78.3	67.4	278,500 *	278,500 *	278,500 *	278,500 *	266,600 *	266,600 *	254,800 *	254,800 *	18
19	77.3	67.1	264,200 *	264,200 *	264,200 *	264,200 *	253,000 *	253,000 *	241,700 *	241,700 *	19
20	76.4	66.8	251,300 *	251,300 *	251,300 *	251,300 *	240,600 *	240,600 *	229,800 *	229,800 *	20
22	74.4	66.2	228,800 *	228,800 *	228,800 *	228,800 *	218,900 *	218,900 *	208,300 *	208,300 *	22
24	72.3	65.5	209,800 *	209,800 *	209,800 *	209,800 *	200,600 *	200,600 *	188,800 *	188,800 *	24
26	70.3	64.8	193,500 *	193,500 *	193,500 *	193,500 *	183,300 *	183,300 *	172,500 *	172,500 *	26
28	68.2	63.9	178,600 *	178,600 *	178,600 *	178,600 *	168,600 *	168,600 *	158,600 *	158,600 *	28
30	66.1	63.0	165,200 *	165,200 *	165,200 *	165,200 *	155,900 *	155,900 *	146,600 *	146,600 *	30
32	64.0	61.9	153,600 *	153,600 *	153,600 *	153,600 *	144,900 *	144,900 *	132,900 *	136,200 *	32
34	61.8	60.8	143,400 *	143,400 *	143,400 *	143,400 *	135,200 *	135,200 *	119,900 *	127,000 *	34
36	59.5	59.6	134,300 *	134,300 *	134,300 *	134,300 *	126,400 *	126,600 *	109,000 *	118,900 *	36
38	57.2	58.2	126,200 *	126,200 *	126,200 *	126,200 *	115,800 *	119,000 *	99,700 *	111,700 *	38
40	54.9	56.8	119,000 *	119,000 *	119,000 *	119,000 *	106,700 *	112,100 *	91,700 *	105,200 *	40
45	48.6	52.5	103,700 *	103,700 *	101,400 *	103,700 *	88,600 *	97,600 *	75,800 *	88,500 *	45
50	41.6	47.1	91,600 *	91,600 *	86,200 *	91,600 *	75,100 *	86,100 *	64,000 *	75,000 *	50
55	33.3	40.0	79,900 *	81,600 *	74,400 *	81,600 *	64,600 *	74,400 *	54,700 *	64,400 *	55
60	22.1	29.4	69,900 *	73,200 *	64,900 *	73,200 *	56,100 *	64,800 *	47,200 *	55,900 *	60

S/N: 7779006



Liftcrane Boom Capacities

Meets
ANSI B30.5
Requirements

Boom No. 78T With Heavy Lift Top
0 Lb. to 95,400 Lb. Crane Counterweight
With or Without 25,000 Lb. Front Bumper Counterweight
Rating Over Rear or 360 Degrees On Fully Extended Outriggers

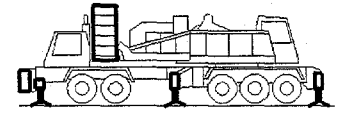

60 Ft. Boom

Oper. Rad. Feet	Boom Ang. Deg.	Boom Point Elev. Feet	44,400 Lb. Crane Counterweight		27,400 Lb. Crane Counterweight		10,400 Lb. Crane Counterweight		0 Lb. Crane Counterweight		Oper. Rad. Feet
			Boom Capacity 360 Deg. Pounds	Boom Capacity Rear Pounds	Boom Capacity 360 Deg. Pounds	Boom Capacity Rear Pounds	Boom Capacity 360 Deg. Pounds	Boom Capacity Rear Pounds	Boom Capacity 360 Deg. Pounds	Boom Capacity Rear Pounds	
14	82.2	68.2	309,100 *	309,100 *	294,200 *	294,200 *	279,300 *	279,300 *	270,200 *	270,200 *	14
15	81.3	68.0	289,500 *	289,500 *	275,500 *	275,500 *	261,500 *	261,500 *	250,700 *	250,700 *	15
16	80.3	67.8	272,200 *	272,200 *	259,000 *	259,000 *	243,900 *	243,900 *	232,800 *	232,800 *	16
17	79.3	67.6	256,800 *	256,800 *	244,300 *	244,300 *	227,600 *	227,600 *	217,200 *	217,200 *	17
18	78.3	67.4	242,900 *	242,900 *	229,200 *	229,200 *	213,200 *	213,200 *	203,500 *	203,500 *	18
19	77.3	67.1	230,400 *	230,400 *	215,500 *	215,500 *	200,500 *	200,500 *	179,900 *	191,300 *	19
20	76.4	66.8	217,600 *	217,600 *	203,300 *	203,300 *	187,800 *	189,100 *	157,600 *	180,400 *	20
22	74.4	66.2	195,400 *	195,400 *	182,500 *	182,500 *	150,000 *	169,600 *	125,400 *	161,700 *	22
24	72.3	65.5	177,000 *	177,000 *	158,000 *	165,300 *	124,100 *	153,500 *	103,400 *	137,100 *	24
26	70.3	64.8	161,600 *	161,600 *	134,500 *	150,800 *	105,200 *	134,400 *	87,300 *	116,200 *	26
28	68.2	63.9	142,500 *	148,600 *	116,700 *	138,500 *	90,900 *	116,400 *	75,100 *	100,400 *	28
30	66.1	63.0	125,700 *	137,300 *	102,600 *	125,600 *	79,600 *	102,200 *	65,600 *	88,000 *	30
32	64.0	61.9	112,100 *	127,500 *	91,300 *	111,900 *	70,500 *	90,800 *	57,800 *	78,000 *	32
34	61.8	60.8	100,900 *	118,800 *	82,000 *	100,700 *	63,000 *	81,500 *	51,400 *	69,800 *	34
36	59.5	59.6	91,500 *	108,900 *	74,100 *	91,300 *	56,700 *	73,600 *	46,100 *	62,900 *	36
38	57.2	58.2	83,600 *	99,600 *	67,400 *	83,300 *	51,300 *	66,900 *	41,500 *	57,000 *	38
40	54.9	56.8	76,700 *	91,500 *	61,700 *	76,400 *	46,700 *	61,200 *	37,500 *	51,900 *	40
45	48.6	52.5	63,000 *	75,600 *	50,300 *	62,700 *	37,500 *	49,800 *	29,700 *	41,900 *	45
50	41.6	47.1	52,800 *	63,700 *	41,700 *	52,500 *	30,600 *	41,300 *	23,800 *	34,400 *	50
55	33.3	40.0	44,900 *	54,500 *	35,000 *	44,500 *	25,200 *	34,600 *	19,200 *	28,500 *	55
60	22.1	29.4	38,400 *	47,000 *	29,600 *	38,100 *	20,700 *	29,200 *	15,300 *	23,700 *	60

Manitowoc Cranes, Inc.

Manitowoc, Wisconsin 54220 U.S.A.



Liftcrane Boom Capacities

Meets
ANSI B30.5
Requirements

Boom No. 78T With Heavy Lift Top
0 Lb. to 95,400 Lb. Crane Counterweight
With or Without 25,000 Lb. Front Bumper Counterweight
Rating Over Rear or 360 Degrees On Fully Extended Outriggers

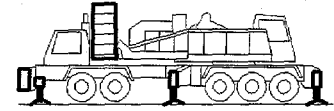

70 Ft. Boom



Oper. Rad. Feet	Boom Ang. Deg.	Boom Point Elev. Feet	95,400 Lb. Crane Cwt. 25,000 Lb. Bumper Cwt.		95,400 Lb. Crane Counterweight		78,400 Lb. Crane Counterweight		61,400 Lb. Crane Counterweight		Oper. Rad. Feet
			Boom Capacity 360 Deg. Pounds	Boom Capacity Rear Pounds	Boom Capacity 360 Deg. Pounds	Boom Capacity Rear Pounds	Boom Capacity 360 Deg. Pounds	Boom Capacity Rear Pounds	Boom Capacity 360 Deg. Pounds	Boom Capacity Rear Pounds	
15	82.5	78.2	296,300 *	296,300 *	296,300 *	296,300 *	296,300 *	296,300 *	296,300 *	296,300 *	15
16	81.7	78.0	294,300 *	294,300 *	294,300 *	294,300 *	294,300 *	294,300 *	286,200 *	286,200 *	16
17	80.9	77.8	292,400 *	292,400 *	292,400 *	292,400 *	282,500 *	282,500 *	270,000 *	270,000 *	17
18	80.0	77.6	279,300 *	279,300 *	279,300 *	279,300 *	267,400 *	267,400 *	255,600 *	255,600 *	18
19	79.2	77.4	265,000 *	265,000 *	265,000 *	265,000 *	253,800 *	253,800 *	242,500 *	242,500 *	19
20	78.4	77.2	252,100 *	252,100 *	252,100 *	252,100 *	241,400 *	241,400 *	230,600 *	230,600 *	20
22	76.7	76.6	229,600 *	229,600 *	229,600 *	229,600 *	219,800 *	219,800 *	209,300 *	209,300 *	22
24	75.0	76.1	210,600 *	210,600 *	210,600 *	210,600 *	201,600 *	201,600 *	189,800 *	189,800 *	24
26	73.2	75.4	194,000 *	194,000 *	194,000 *	194,000 *	184,300 *	184,300 *	173,500 *	173,500 *	26
28	71.5	74.7	179,600 *	179,600 *	179,600 *	179,600 *	169,600 *	169,600 *	159,600 *	159,600 *	28
30	69.7	73.9	166,200 *	166,200 *	166,200 *	166,200 *	156,900 *	156,900 *	147,600 *	147,600 *	30
32	68.0	73.1	154,600 *	154,600 *	154,600 *	154,600 *	145,900 *	145,900 *	134,700 *	137,200 *	32
34	66.2	72.1	144,400 *	144,400 *	144,400 *	144,400 *	136,200 *	136,200 *	121,700 *	128,100 *	34
36	64.3	71.1	135,400 *	135,400 *	135,400 *	135,400 *	127,700 *	127,700 *	110,700 *	120,000 *	36
38	62.5	70.0	127,300 *	127,300 *	127,300 *	127,300 *	117,600 *	120,000 *	101,400 *	112,700 *	38
40	60.6	68.9	120,100 *	120,100 *	120,100 *	120,100 *	108,400 *	113,200 *	93,400 *	106,300 *	40
45	55.6	65.5	104,900 *	104,900 *	103,000 *	104,900 *	90,300 *	98,800 *	77,500 *	90,200 *	45
50	50.4	61.5	92,800 *	92,800 *	87,900 *	92,800 *	76,800 *	87,300 *	65,700 *	76,700 *	50
55	44.6	56.6	81,700 *	82,900 *	76,200 *	82,900 *	66,400 *	76,200 *	56,500 *	66,200 *	55
60	38.2	50.5	71,800 *	74,600 *	66,800 *	74,600 *	58,000 *	66,800 *	49,200 *	57,900 *	60
65	30.6	42.6	63,700 *	67,600 *	59,200 *	67,200 *	51,200 *	59,100 *	43,100 *	51,000 *	65
70	20.3	31.1	56,800 *	61,600 *	52,700 *	60,000 *	45,300 *	52,600 *	38,000 *	45,200 *	70

Manitowoc Cranes, Inc.

Manitowoc, Wisconsin 54220 U.S.A.



777T

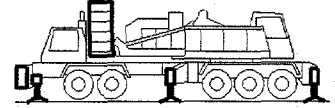

Liftcrane Boom Capacities

Meets
ANSI B30.5
Requirements

Boom No. 78T With Heavy Lift Top
0 Lb. to 95,400 Lb. Crane Counterweight
With or Without 25,000 Lb. Front Bumper Counterweight
Rating Over Rear or 360 Degrees On Fully Extended Outriggers

70 Ft. Boom

Oper. Rad. Feet	Boom Ang. Deg.	Boom Point Elev. Feet	44,400 Lb. Crane Counterweight		27,400 Lb. Crane Counterweight		10,400 Lb. Crane Counterweight		0 Lb. Crane Counterweight		Oper. Rad. Feet
			Boom Capacity 360 Deg. Pounds	Boom Capacity Rear Pounds	Boom Capacity 360 Deg. Pounds	Boom Capacity Rear Pounds	Boom Capacity 360 Deg. Pounds	Boom Capacity Rear Pounds	Boom Capacity 360 Deg. Pounds	Boom Capacity Rear Pounds	
15	82.5	78.2	290,300 *	290,300 *	276,300 *	276,300 *	262,300 *	262,300 *	251,700 *	251,700 *	15
16	81.7	78.0	273,000 *	273,000 *	259,800 *	259,800 *	244,800 *	244,800 *	233,800 *	233,800 *	16
17	80.9	77.8	257,600 *	257,600 *	245,100 *	245,100 *	228,500 *	228,500 *	218,200 *	218,200 *	17
18	80.0	77.6	243,700 *	243,700 *	230,200 *	230,200 *	214,200 *	214,200 *	204,500 *	204,500 *	18
19	79.2	77.4	231,200 *	231,200 *	216,500 *	216,500 *	201,400 *	201,400 *	182,900	192,300 *	19
20	78.4	77.2	218,600 *	218,600 *	204,300 *	204,300 *	190,000 *	190,000 *	160,300	181,400 *	20
22	76.7	76.6	196,400 *	196,400 *	183,500 *	183,500 *	152,400	170,600 *	127,800	162,700 *	22
24	75.0	76.1	178,000 *	178,000 *	160,200	166,300 *	126,300	154,500 *	105,600	139,300	24
26	73.2	75.4	162,700 *	162,700 *	136,600	151,800 *	107,300	136,500	89,400	118,300	26
28	71.5	74.7	144,400	149,600 *	118,600	139,600 *	92,800	118,400	77,100	102,400	28
30	69.7	73.9	127,600	138,300 *	104,500	127,500	81,500	104,100	67,400	89,900	30
32	68.0	73.1	113,900	128,500 *	93,100	113,800	72,300	92,700	59,600	79,800	32
34	66.2	72.1	102,700	119,900 *	83,700	102,500	64,800	83,300	53,200	71,600	34
36	64.3	71.1	93,300	110,700	75,900	93,000	58,400	75,400	47,800	64,600	36
38	62.5	70.0	85,300	101,300	69,200	85,000	53,000	68,700	43,200	58,700	38
40	60.6	68.9	78,400	93,300	63,400	78,100	48,400	62,900	39,300	53,700	40
45	55.6	65.5	64,700	77,300	51,900	64,400	39,200	51,500	31,400	43,600	45
50	50.4	61.5	54,500	65,400	43,400	54,200	32,300	43,000	25,500	36,100	50
55	44.6	56.6	46,700	56,300	36,800	46,300	27,000	36,400	21,000	30,300	55
60	38.2	50.5	40,300	48,900	31,500	40,000	22,700	31,100	17,300	25,700	60
65	30.6	42.6	35,100	42,900	27,100	34,800	19,100	26,700	14,200	21,800	65
70	20.3	31.1	30,700	37,800	23,300	30,400	16,000	23,000	11,600	18,500	70

Manitowoc Cranes, Inc.

Manitowoc, Wisconsin 54220 U.S.A.



Liftcrane Boom Capacities

Meets
ANSI B30.5
Requirements

Boom No. 78T With Heavy Lift Top
0 Lb. to 95,400 Lb. Crane Counterweight
With or Without 25,000 Lb. Front Bumper Counterweight
Rating Over Rear or 360 Degrees On Fully Extended Outriggers

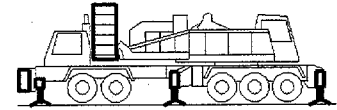

80 Ft. Boom



Oper. Rad. Feet	Boom Ang. Deg.	Boom Point Elev. Feet	95,400 Lb. Crane Cwt. 25,000 Lb. Bumper Cwt.		95,400 Lb. Crane Counterweight		78,400 Lb. Crane Counterweight		61,400 Lb. Crane Counterweight		Oper. Rad. Feet
			Boom Capacity 360 Deg. Pounds	Boom Capacity Rear Pounds	Boom Capacity 360 Deg. Pounds	Boom Capacity Rear Pounds	Boom Capacity 360 Deg. Pounds	Boom Capacity Rear Pounds	Boom Capacity 360 Deg. Pounds	Boom Capacity Rear Pounds	
16	82.7	88.1	280,600 *	280,600 *	280,600 *	280,600 *	280,600 *	280,600 *	280,600 *	280,600 *	16
17	82.0	88.0	278,500 *	278,500 *	278,500 *	278,500 *	278,500 *	278,500 *	269,900 *	269,900 *	17
18	81.3	87.8	276,500 *	276,500 *	276,500 *	276,500 *	267,200 *	267,200 *	255,400 *	255,400 *	18
19	80.6	87.6	264,900 *	264,900 *	264,900 *	264,900 *	253,600 *	253,600 *	242,300 *	242,300 *	19
20	79.8	87.4	252,000 *	252,000 *	252,000 *	252,000 *	241,200 *	241,200 *	230,500 *	230,500 *	20
22	78.4	87.0	229,400 *	229,400 *	229,400 *	229,400 *	219,600 *	219,600 *	209,300 *	209,300 *	22
24	76.9	86.4	210,500 *	210,500 *	210,500 *	210,500 *	201,400 *	201,400 *	189,800 *	189,800 *	24
26	75.4	85.9	194,300 *	194,300 *	194,300 *	194,300 *	184,300 *	184,300 *	173,400 *	173,400 *	26
28	73.9	85.3	179,600 *	179,600 *	179,600 *	179,600 *	169,600 *	169,600 *	159,600 *	159,600 *	28
30	72.4	84.6	166,200 *	166,200 *	166,200 *	166,200 *	156,900 *	156,900 *	147,600 *	147,600 *	30
32	70.9	83.9	154,600 *	154,600 *	154,600 *	154,600 *	145,900 *	145,900 *	135,400 *	137,200 *	32
34	69.3	83.1	144,400 *	144,400 *	144,400 *	144,400 *	136,200 *	136,200 *	122,200 *	128,000 *	34
36	67.8	82.2	135,400 *	135,400 *	135,400 *	135,400 *	127,700 *	127,700 *	111,300 *	120,000 *	36
38	66.2	81.3	127,300 *	127,300 *	127,300 *	127,300 *	118,000 *	120,000 *	101,900 *	112,700 *	38
40	64.6	80.3	120,100 *	120,100 *	120,100 *	120,100 *	108,900 *	113,200 *	93,900 *	106,300 *	40
45	60.5	77.5	104,900 *	104,900 *	103,500 *	104,900 *	90,700 *	98,800 *	77,900 *	90,600 *	45
50	56.2	74.2	92,800 *	92,800 *	88,300 *	92,800 *	77,200 *	87,300 *	66,000 *	77,100 *	50
55	51.7	70.3	82,100 *	83,000 *	76,600 *	83,000 *	66,700 *	76,500 *	56,900 *	66,600 *	55
60	46.8	65.8	72,200 *	74,800 *	67,300 *	74,800 *	58,400 *	67,200 *	49,600 *	58,300 *	60
65	41.5	60.3	64,100 *	67,800 *	59,600 *	67,600 *	51,600 *	59,500 *	43,600 *	51,500 *	65
70	35.5	53.6	57,400 *	61,900 *	53,300 *	60,600 *	45,900 *	53,200 *	38,600 *	45,800 *	70
75	28.4	45.0	51,600 *	56,700 *	47,900 *	54,600 *	41,100 *	47,700 *	34,300 *	40,900 *	75
80	18.8	32.6	46,600 *	52,000 *	43,100 *	49,300 *	36,900 *	43,000 *	30,600 *	36,700 *	80

Manitowoc Cranes, Inc.

Manitowoc, Wisconsin 54220 U.S.A.



777T

Liftcrane Boom Capacities

Boom No. 78T With Heavy Lift Top
 0 Lb. to 95,400 Lb. Crane Counterweight
 With or Without 25,000 Lb. Front Bumper Counterweight
 Rating Over Rear or 360 Degrees On Fully Extended Outriggers

Meets
 ANSI B30.5
 Requirements

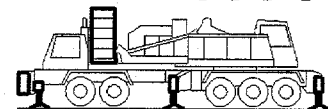

80 Ft. Boom



Oper. Rad. Feet	Boom Ang. Deg.	Boom Point Elev. Feet	44,400 Lb. Crane Counterweight		27,400 Lb. Crane Counterweight		10,400 Lb. Crane Counterweight		0 Lb. Crane Counterweight		Oper. Rad. Feet
			Boom Capacity 360 Deg. Pounds	Boom Capacity Rear Pounds	Boom Capacity 360 Deg. Pounds	Boom Capacity Rear Pounds	Boom Capacity 360 Deg. Pounds	Boom Capacity Rear Pounds	Boom Capacity 360 Deg. Pounds	Boom Capacity Rear Pounds	
16	82.7	88.1	272,800 *	272,800 *	259,600 *	259,600 *	244,900 *	244,900 *	233,800 *	233,800 *	16
17	82.0	88.0	257,400 *	257,400 *	244,900 *	244,900 *	228,600 *	228,600 *	218,200 *	218,200 *	17
18	81.3	87.8	243,500 *	243,500 *	230,200 *	230,200 *	214,200 *	214,200 *	204,500 *	204,500 *	18
19	80.6	87.6	231,100 *	231,100 *	216,500 *	216,500 *	201,400 *	201,400 *	184,600 *	192,300 *	19
20	79.8	87.4	218,600 *	218,600 *	204,300 *	204,300 *	190,000 *	190,000 *	161,800 *	181,400 *	20
22	78.4	87.0	196,400 *	196,400 *	183,500 *	183,500 *	153,600 *	170,600 *	129,000 *	162,700 *	22
24	76.9	86.4	178,000 *	178,000 *	161,200 *	166,200 *	127,300 *	154,500 *	106,600 *	140,400 *	24
26	75.4	85.9	162,600 *	162,600 *	137,500 *	151,800 *	108,100 *	137,400 *	90,300 *	119,200 *	26
28	73.9	85.3	145,200 *	149,600 *	119,400 *	139,500 *	93,600 *	119,100 *	77,900 *	103,200 *	28
30	72.4	84.6	128,200 *	138,300 *	105,200 *	128,200 *	82,200 *	104,800 *	68,100 *	90,600 *	30
32	70.9	83.9	114,500 *	128,500 *	93,700 *	114,400 *	72,900 *	93,300 *	60,200 *	80,500 *	32
34	69.3	83.1	103,300 *	119,900 *	84,300 *	103,100 *	65,300 *	83,800 *	53,800 *	72,100 *	34
36	67.8	82.2	93,800 *	111,200 *	76,400 *	93,600 *	58,900 *	75,900 *	48,300 *	65,100 *	36
38	66.2	81.3	85,800 *	101,800 *	69,600 *	85,500 *	53,500 *	69,200 *	43,700 *	59,200 *	38
40	64.6	80.3	78,900 *	93,700 *	63,800 *	78,500 *	48,800 *	63,400 *	39,700 *	54,100 *	40
45	60.5	77.5	65,100 *	77,700 *	52,400 *	64,800 *	39,600 *	51,900 *	31,800 *	44,000 *	45
50	56.2	74.2	54,900 *	65,800 *	43,800 *	54,600 *	32,700 *	43,400 *	25,900 *	36,500 *	50
55	51.7	70.3	47,000 *	56,700 *	37,200 *	46,700 *	27,300 *	36,800 *	21,300 *	30,700 *	55
60	46.8	65.8	40,700 *	49,300 *	31,900 *	40,400 *	23,100 *	31,500 *	17,700 *	26,100 *	60
65	41.5	60.3	35,600 *	43,400 *	27,600 *	35,300 *	19,600 *	27,200 *	14,700 *	22,300 *	65
70	35.5	53.6	31,300 *	38,400 *	23,900 *	31,000 *	16,600 *	23,600 *	12,200 *	19,100 *	70
75	28.4	45.0	27,600 *	34,100 *	20,800 *	27,300 *	14,100 *	20,500 *	10,000 *	16,400 *	75
80	18.8	32.6	24,300 *	30,400 *	18,100 *	24,100 *	11,800 *	17,800 *	8,000 *	13,900 *	80

Manitowoc Cranes, Inc.

Manitowoc, Wisconsin 54220 U.S.A.



777T

Liftcrane Boom Capacities

Meets
ANSI B30.5
Requirements

Boom No. 78T With Heavy Lift Top
0 Lb. to 95,400 Lb. Crane Counterweight
With or Without 25,000 Lb. Front Bumper Counterweight
Rating Over Rear or 360 Degrees On Fully Extended Outriggers

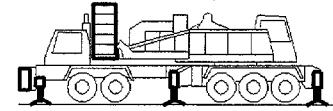

90 Ft. Boom



Oper. Rad. Feet	Boom Ang. Deg.	Boom Point Elev. Feet	95,400 Lb. Crane Cwt. 25,000 Lb. Bumper Cwt.		95,400 Lb. Crane Counterweight		78,400 Lb. Crane Counterweight		61,400 Lb. Crane Counterweight		Oper. Rad. Feet
			Boom Capacity 360 Deg. Pounds	Boom Capacity Rear Pounds	Boom Capacity 360 Deg. Pounds	Boom Capacity Rear Pounds	Boom Capacity 360 Deg. Pounds	Boom Capacity Rear Pounds	Boom Capacity 360 Deg. Pounds	Boom Capacity Rear Pounds	
17	82.9	98.1	273,700 *	273,700 *	273,700 *	273,700 *	273,700 *	273,700 *	269,700 *	269,700 *	17
18	82.3	97.9	265,300 *	265,300 *	265,300 *	265,300 *	265,300 *	265,300 *	255,200 *	255,200 *	18
19	81.6	97.8	256,200 *	256,200 *	256,200 *	256,200 *	253,400 *	253,400 *	242,200 *	242,200 *	19
20	81.0	97.6	247,500 *	247,500 *	247,500 *	247,500 *	241,100 *	241,100 *	230,300 *	230,300 *	20
22	79.7	97.2	229,300 *	229,300 *	229,300 *	229,300 *	219,500 *	219,500 *	209,200 *	209,200 *	22
24	78.4	96.8	210,300 *	210,300 *	210,300 *	210,300 *	201,300 *	201,300 *	189,800 *	189,800 *	24
26	77.1	96.3	194,100 *	194,100 *	194,100 *	194,100 *	184,200 *	184,200 *	173,400 *	173,400 *	26
28	75.7	95.7	179,500 *	179,500 *	179,500 *	179,500 *	169,500 *	169,500 *	159,500 *	159,500 *	28
30	74.4	95.1	166,200 *	166,200 *	166,200 *	166,200 *	156,900 *	156,900 *	147,600 *	147,600 *	30
32	73.1	94.5	154,600 *	154,600 *	154,600 *	154,600 *	145,900 *	145,900 *	135,800 *	137,200 *	32
34	71.7	93.8	144,400 *	144,400 *	144,400 *	144,400 *	136,200 *	136,200 *	122,700 *	128,000 *	34
36	70.4	93.0	135,300 *	135,300 *	135,300 *	135,300 *	127,600 *	127,600 *	111,700 *	119,900 *	36
38	69.0	92.2	127,300 *	127,300 *	127,300 *	127,300 *	118,400 *	120,000 *	102,300 *	112,700 *	38
40	67.6	91.4	120,100 *	120,100 *	120,100 *	120,100 *	109,200 *	113,200 *	94,200 *	106,200 *	40
45	64.1	89.0	104,900 *	104,900 *	103,800 *	104,900 *	91,000 *	98,800 *	78,200 *	90,900 *	45
50	60.4	86.2	92,800 *	92,800 *	88,600 *	92,800 *	77,500 *	87,300 *	66,300 *	77,400 *	50
55	56.6	82.9	82,400 *	83,000 *	76,900 *	83,000 *	67,000 *	76,800 *	57,200 *	66,900 *	55
60	52.7	79.2	72,500 *	74,800 *	67,500 *	74,800 *	58,700 *	67,500 *	49,900 *	58,500 *	60
65	48.5	74.8	64,400 *	67,900 *	59,900 *	67,900 *	51,900 *	59,800 *	43,900 *	51,800 *	65
70	43.9	69.8	57,700 *	62,000 *	53,600 *	60,900 *	46,300 *	53,500 *	38,900 *	46,100 *	70
75	39.0	63.8	52,000 *	56,800 *	48,200 *	54,900 *	41,500 *	48,100 *	34,700 *	41,300 *	75
80	33.4	56.6	47,100 *	52,300 *	43,600 *	49,800 *	37,300 *	43,500 *	31,100 *	37,200 *	80
85	26.7	47.3	42,800 *	48,300 *	39,600 *	45,400 *	33,700 *	39,500 *	27,900 *	33,600 *	85
90	17.6	34.1	39,000 *	44,700 *	36,000 *	41,400 *	30,500 *	35,900 *	25,000 *	30,400 *	90

S/N: 7779006

Manitowoc Cranes, Inc.

Manitowoc, Wisconsin 54220 U.S.A.



777T

Liftcrane Boom Capacities

Boom No. 78T With Heavy Lift Top
 0 Lb. to 95,400 Lb. Crane Counterweight
 With or Without 25,000 Lb. Front Bumper Counterweight
 Rating Over Rear or 360 Degrees On Fully Extended Outriggers

Meets
ANSI B30.5
Requirements

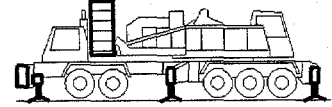

90 Ft. Boom



Oper. Rad. Feet	Boom Ang. Deg.	Boom Point Elev. Feet	44,400 Lb. Crane Counterweight		27,400 Lb. Crane Counterweight		10,400 Lb. Crane Counterweight		0 Lb. Crane Counterweight		Oper. Rad. Feet
			Boom Capacity 360 Deg. Pounds	Boom Capacity Rear Pounds	Boom Capacity 360 Deg. Pounds	Boom Capacity Rear Pounds	Boom Capacity 360 Deg. Pounds	Boom Capacity Rear Pounds	Boom Capacity 360 Deg. Pounds	Boom Capacity Rear Pounds	
17	82.9	98.1	257,200 *	257,200 *	244,700 *	244,700 *	228,500 *	228,500 *	218,200 *	218,200 *	17
18	82.3	97.9	243,400 *	243,400 *	230,200 *	230,200 *	214,200 *	214,200 *	204,500 *	204,500 *	18
19	81.6	97.8	230,900 *	230,900 *	216,500 *	216,500 *	201,400 *	201,400 *	185,900	192,300 *	19
20	81.0	97.6	218,600 *	218,600 *	204,300 *	204,300 *	190,000 *	190,000 *	163,000	181,300 *	20
22	79.7	97.2	196,300 *	196,300 *	183,400 *	183,400 *	154,600	170,500 *	130,000	162,700 *	22
24	78.4	96.8	178,000 *	178,000 *	162,000	166,200 *	128,100	154,500 *	107,400	141,200	24
26	77.1	96.3	162,600 *	162,600 *	138,200	151,800 *	108,800	138,100	91,000	119,900	26
28	75.7	95.7	145,800	149,500 *	120,000	139,500 *	94,200	119,800	78,500	103,800	28
30	74.4	95.1	128,800	138,300 *	105,700	128,800	82,700	105,400	68,700	91,100	30
32	73.1	94.5	115,000	128,500 *	94,200	114,900	73,400	93,800	60,700	81,000	32
34	71.7	93.8	103,700	119,800 *	84,700	103,500	65,800	84,300	54,200	72,600	34
36	70.4	93.0	94,200	111,600	76,800	94,000	59,300	76,300	48,700	65,600	36
38	69.0	92.2	86,200	102,200	70,000	85,900	53,900	69,600	44,100	59,600	38
40	67.6	91.4	79,200	94,100	64,200	78,900	49,200	63,700	40,100	54,500	40
45	64.1	89.0	65,400	78,000	52,700	65,100	39,900	52,200	32,100	44,300	45
50	60.4	86.2	55,200	66,100	44,100	54,900	33,000	43,700	26,200	36,800	50
55	56.6	82.9	47,300	56,900	37,500	47,000	27,600	37,100	21,600	31,000	55
60	52.7	79.2	41,000	49,600	32,200	40,700	23,300	31,800	18,000	26,400	60
65	48.5	74.8	35,900	43,700	27,900	35,600	19,800	27,500	15,000	22,600	65
70	43.9	69.8	31,600	38,700	24,300	31,300	16,900	23,900	12,500	19,400	70
75	39.0	63.8	28,000	34,500	21,200	27,700	14,400	20,900	10,300	16,700	75
80	33.4	56.6	24,800	30,900	18,600	24,600	12,300	18,200	8,500	14,400	80
85	26.7	47.3	22,100	27,700	16,200	21,800	10,400	15,900	6,800	12,300	85
90	17.6	34.1	19,600	24,800	14,100	19,300	8,600	13,800	5,300	10,500	90

S/N: 7779006

Manitowoc Cranes, Inc.

Manitowoc, Wisconsin 54220 U.S.A.



Liftcrane Boom Capacities

Meets
ANSI B30.5
Requirements

Boom No. 78T With Heavy Lift Top
0 Lb. to 95,400 Lb. Crane Counterweight
With or Without 25,000 Lb. Front Bumper Counterweight
Rating Over Rear or 360 Degrees On Fully Extended Outriggers

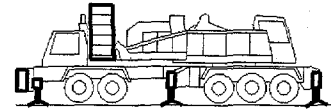

100 Ft. Boom



Oper. Rad. Feet	Boom Ang. Deg.	Boom Point Elev. Feet	95,400 Lb. Crane Cwt. 25,000 Lb. Bumper Cwt.		95,400 Lb. Crane Counterweight		78,400 Lb. Crane Counterweight		61,400 Lb. Crane Counterweight		Oper. Rad. Feet
			Boom Capacity 360 Deg. Pounds	Boom Capacity Rear Pounds	Boom Capacity 360 Deg. Pounds	Boom Capacity Rear Pounds	Boom Capacity 360 Deg. Pounds	Boom Capacity Rear Pounds	Boom Capacity 360 Deg. Pounds	Boom Capacity Rear Pounds	
18	83.0	108.1	241,200 *	241,200 *	241,200 *	241,200 *	241,200 *	241,200 *	241,200 *	241,200 *	18
19	82.5	107.9	233,200 *	233,200 *	233,200 *	233,200 *	233,200 *	233,200 *	233,200 *	233,200 *	19
20	81.9	107.7	225,800 *	225,800 *	225,800 *	225,800 *	225,800 *	225,800 *	225,800 *	225,800 *	20
22	80.7	107.4	211,900 *	211,900 *	211,900 *	211,900 *	211,900 *	211,900 *	209,000 *	209,000 *	22
24	79.6	107.0	199,600 *	199,600 *	199,600 *	199,600 *	199,600 *	199,600 *	189,500 *	189,500 *	24
26	78.4	106.5	188,700 *	188,700 *	188,700 *	188,700 *	184,000 *	184,000 *	173,200 *	173,200 *	26
28	77.2	106.1	178,700 *	178,700 *	178,700 *	178,700 *	169,300 *	169,300 *	159,300 *	159,300 *	28
30	76.0	105.5	166,000 *	166,000 *	166,000 *	166,000 *	156,700 *	156,700 *	147,300 *	147,300 *	30
32	74.8	105.0	154,300 *	154,300 *	154,300 *	154,300 *	145,600 *	145,600 *	136,100	136,900 *	32
34	73.6	104.3	144,100 *	144,100 *	144,100 *	144,100 *	136,000 *	136,000 *	122,900	127,800 *	34
36	72.4	103.7	135,100 *	135,100 *	135,100 *	135,100 *	127,400 *	127,400 *	111,800	119,700 *	36
38	71.2	103.0	127,100 *	127,100 *	127,100 *	127,100 *	118,600	119,800 *	102,400	112,500 *	38
40	70.0	102.2	119,800 *	119,800 *	119,800 *	119,800 *	109,300	112,900 *	94,300	106,000 *	40
45	66.9	100.1	104,700 *	104,700 *	103,800	104,700 *	91,100	98,500 *	78,300	91,000	45
50	63.7	97.6	92,600 *	92,600 *	88,600	92,600 *	77,500	87,100 *	66,400	77,400	50
55	60.4	94.8	82,400	82,800 *	76,900	82,800 *	67,000	76,800	57,200	66,900	55
60	57.0	91.6	72,500	74,600 *	67,500	74,600 *	58,700	67,500	49,900	58,600	60
65	53.4	88.0	64,400	67,700 *	59,900	67,700 *	51,900	59,800	43,900	51,800	65
70	49.7	83.8	57,700	61,800 *	53,600	60,900	46,300	53,500	38,900	46,100	70
75	45.8	79.0	52,000	56,700 *	48,200	55,000	41,500	48,100	34,700	41,300	75
80	41.5	73.5	47,200	52,200 *	43,700	49,900	37,400	43,500	31,100	37,200	80
85	36.8	67.1	42,900	48,200 *	39,700	45,400	33,800	39,600	28,000	33,700	85
90	31.5	59.3	39,200	44,700 *	36,200	41,600	30,700	36,100	25,200	30,500	90
95	25.2	49.5	35,900	41,500 *	33,000	38,100	27,900	32,900	22,800	27,700	95
100	16.6	35.4	32,900	38,600 *	30,200	35,000	25,300	30,100	20,500	25,200	100

Manitowoc Cranes, Inc.

Manitowoc, Wisconsin 54220 U.S.A.



Liftcrane Boom Capacities

Meets
ANSI B30.5
Requirements

Boom No. 78T With Heavy Lift Top
0 Lb. to 95,400 Lb. Crane Counterweight
With or Without 25,000 Lb. Front Bumper Counterweight
Rating Over Rear or 360 Degrees On Fully Extended Outriggers

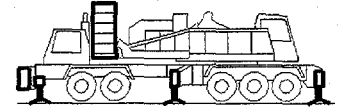

100 Ft. Boom

Oper. Rad. Feet	Boom Ang. Deg.	Boom Point Elev. Feet	44,400 Lb. Crane Counterweight		27,400 Lb. Crane Counterweight		10,400 Lb. Crane Counterweight		0 Lb. Crane Counterweight		Oper. Rad. Feet
			Boom Capacity 360 Deg. Pounds	Boom Capacity Rear Pounds	Boom Capacity 360 Deg. Pounds	Boom Capacity Rear Pounds	Boom Capacity 360 Deg. Pounds	Boom Capacity Rear Pounds	Boom Capacity 360 Deg. Pounds	Boom Capacity Rear Pounds	
18	83.0	108.1	241,200 *	241,200 *	230,000 *	230,000 *	214,000 *	214,000 *	204,300 *	204,300 *	18
19	82.5	107.9	230,600 *	230,600 *	216,300 *	216,300 *	201,200 *	201,200 *	187,200	192,100 *	19
20	81.9	107.7	218,400 *	218,400 *	204,100 *	204,100 *	189,800 *	189,800 *	164,100	181,200 *	20
22	80.7	107.4	196,100 *	196,100 *	183,200 *	183,200 *	155,400	170,300 *	130,800	162,500 *	22
24	79.6	107.0	177,800 *	177,800 *	162,700	166,000 *	128,700	154,200 *	108,000	141,800	24
26	78.4	106.5	162,400 *	162,400 *	138,700	151,600 *	109,300	138,600	91,500	120,400	26
28	77.2	106.1	146,200	149,300 *	120,400	139,300 *	94,600	120,200	78,900	104,200	28
30	76.0	105.5	129,100	138,000 *	106,100	128,700 *	83,000	105,700	69,000	91,500	30
32	74.8	105.0	115,300	128,200 *	94,500	115,200	73,700	94,100	61,000	81,200	32
34	73.6	104.3	103,900	119,600 *	85,000	103,800	66,000	84,500	54,400	72,800	34
36	72.4	103.7	94,400	111,800	77,000	94,200	59,500	76,500	48,900	65,800	36
38	71.2	103.0	86,300	102,400	70,200	86,000	54,100	69,700	44,200	59,800	38
40	70.0	102.2	79,300	94,200	64,300	79,000	49,300	63,900	40,200	54,600	40
45	66.9	100.1	65,500	78,100	52,700	65,200	40,000	52,300	32,200	44,400	45
50	63.7	97.6	55,300	66,200	44,100	54,900	33,000	43,700	26,200	36,900	50
55	60.4	94.8	47,300	57,000	37,500	47,000	27,600	37,100	21,600	31,000	55
60	57.0	91.6	41,000	49,600	32,200	40,700	23,300	31,800	18,000	26,400	60
65	53.4	88.0	35,900	43,700	27,900	35,600	19,900	27,500	15,000	22,600	65
70	49.7	83.8	31,600	38,700	24,300	31,300	16,900	23,900	12,500	19,400	70
75	45.8	79.0	28,000	34,500	21,200	27,700	14,500	20,900	10,300	16,700	75
80	41.5	73.5	24,900	30,900	18,600	24,600	12,300	18,300	8,500	14,400	80
85	36.8	67.1	22,200	27,800	16,300	21,900	10,500	16,000	6,900	12,400	85
90	31.5	59.3	19,800	25,000	14,300	19,500	8,800	14,000	5,500	10,700	90
95	25.2	49.5	17,600	22,600	12,500	17,400	7,300	12,200	4,200	9,100	95
100	16.6	35.4	15,600	20,300	10,800	15,400	5,900	10,500	3,000	7,600	100

S/N: 7779006

Manitowoc Cranes, Inc.

Manitowoc, Wisconsin 54220 U.S.A.



777T

Liftcrane Boom Capacities

Meets
ANSI B30.5
Requirements

Boom No. 78T With Heavy Lift Top
0 Lb. to 95,400 Lb. Crane Counterweight
With or Without 25,000 Lb. Front Counterweight
Rating Over Rear or 360 Degrees On Fully Extended Outriggers

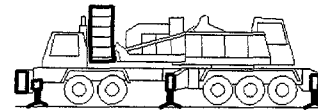

110 Ft. Boom



Oper. Rad. Feet	Boom Ang. Deg.	Boom Point Elev. Feet	95,400 Lb. Crane Cwt. 25,000 Lb. Bumper Cwt.		95,400 Lb. Crane Counterweight		78,400 Lb. Crane Counterweight		61,400 Lb. Crane Counterweight		Oper. Rad. Feet
			Boom Capacity 360 Deg. Pounds	Boom Capacity Rear Pounds	Boom Capacity 360 Deg. Pounds	Boom Capacity Rear Pounds	Boom Capacity 360 Deg. Pounds	Boom Capacity Rear Pounds	Boom Capacity 360 Deg. Pounds	Boom Capacity Rear Pounds	
20	82.6	117.9	208,800 *	208,800 *	208,800 *	208,800 *	208,800 *	208,800 *	208,800 *	208,800 *	20
22	81.6	117.5	196,700 *	196,700 *	196,700 *	196,700 *	196,700 *	196,700 *	196,700 *	196,700 *	22
24	80.5	117.2	185,800 *	185,800 *	185,800 *	185,800 *	185,800 *	185,800 *	185,800 *	185,800 *	24
26	79.5	116.8	176,000 *	176,000 *	176,000 *	176,000 *	176,000 *	176,000 *	173,100 *	173,100 *	26
28	78.4	116.3	167,000 *	167,000 *	167,000 *	167,000 *	167,000 *	167,000 *	159,200 *	159,200 *	28
30	77.3	115.9	158,800 *	158,800 *	158,800 *	158,800 *	156,500 *	156,500 *	147,200 *	147,200 *	30
32	76.2	115.4	151,300 *	151,300 *	151,300 *	151,300 *	145,500 *	145,500 *	136,400 *	136,800 *	32
34	75.2	114.8	144,000 *	144,000 *	144,000 *	144,000 *	135,800 *	135,800 *	123,100 *	127,700 *	34
36	74.1	114.2	135,000 *	135,000 *	135,000 *	135,000 *	127,300 *	127,300 *	112,000 *	119,600 *	36
38	73.0	113.6	126,900 *	126,900 *	126,900 *	126,900 *	118,700 *	119,600 *	102,600 *	112,400 *	38
40	71.9	112.9	119,700 *	119,700 *	119,700 *	119,700 *	109,500 *	112,800 *	94,500 *	105,900 *	40
45	69.1	111.0	104,500 *	104,500 *	103,900 *	104,500 *	91,200 *	98,400 *	78,400 *	91,100 *	45
50	66.3	108.8	92,500 *	92,500 *	88,700 *	92,500 *	77,600 *	87,000 *	66,500 *	77,500 *	50
55	63.3	106.3	82,500 *	82,600 *	76,900 *	82,600 *	67,100 *	76,900 *	57,200 *	67,000 *	55
60	60.4	103.5	72,500 *	74,500 *	67,600 *	74,500 *	58,700 *	67,500 *	49,900 *	58,600 *	60
65	57.3	100.3	64,400 *	67,600 *	60,000 *	67,600 *	51,900 *	59,900 *	43,900 *	51,800 *	65
70	54.1	96.7	57,700 *	61,700 *	53,600 *	60,900 *	46,300 *	53,500 *	39,000 *	46,100 *	70
75	50.7	92.7	52,100 *	56,600 *	48,300 *	55,000 *	41,500 *	48,200 *	34,800 *	41,400 *	75
80	47.2	88.2	47,200 *	52,100 *	43,700 *	49,900 *	37,400 *	43,600 *	31,200 *	37,300 *	80
85	43.5	83.0	43,000 *	48,200 *	39,700 *	45,500 *	33,900 *	39,600 *	28,100 *	33,700 *	85
90	39.4	77.1	39,300 *	44,700 *	36,200 *	41,700 *	30,800 *	36,100 *	25,300 *	30,600 *	90
95	35.0	70.2	36,000 *	41,500 *	33,200 *	38,200 *	28,000 *	33,100 *	22,900 *	27,900 *	95
100	30.0	61.9	33,100 *	38,700 *	30,400 *	35,200 *	25,600 *	30,300 *	20,700 *	25,400 *	100
105	24.0	51.6	30,500 *	36,100 *	27,900 *	32,400 *	23,300 *	27,800 *	18,700 *	23,200 *	105
110	15.8	36.7	28,100 *	33,600 *	25,600 *	29,900 *	21,300 *	25,500 *	16,900 *	21,100 *	110

S/N: 7779006

Manitowoc Cranes, Inc.

Manitowoc, Wisconsin 54220 U.S.A.



Liftcrane Boom Capacities

Meets
ANSI B30.5
Requirements

Boom No. 78T With Heavy Lift Top
0 Lb. to 95,400 Lb. Crane Counterweight
With or Without 25,000 Lb. Front Bumper Counterweight
Rating Over Rear or 360 Degrees On Fully Extended Outriggers

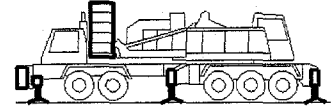

110 Ft. Boom

Oper. Rad. Feet	Boom Ang. Deg.	Boom Point Elev. Feet	44,400 Lb. Crane Counterweight		27,400 Lb. Crane Counterweight		10,400 Lb. Crane Counterweight		0 Lb. Crane Counterweight		Oper. Rad. Feet
			Boom Capacity 360 Deg. Pounds	Boom Capacity Rear Pounds	Boom Capacity 360 Deg. Pounds	Boom Capacity Rear Pounds	Boom Capacity 360 Deg. Pounds	Boom Capacity Rear Pounds	Boom Capacity 360 Deg. Pounds	Boom Capacity Rear Pounds	
20	82.6	117.9	208,800 *	208,800 *	204,000 *	204,000 *	189,700 *	189,700 *	164,900	181,000 *	20
22	81.6	117.5	196,000 *	196,000 *	183,100 *	183,100 *	156,000	170,200 *	131,500	162,400 *	22
24	80.5	117.2	177,600 *	177,600 *	163,200	165,900 *	129,200	154,100 *	108,600	142,400	24
26	79.5	116.8	162,300 *	162,300 *	139,100	151,400 *	109,800	139,100	91,900	120,900	26
28	78.4	116.3	146,600	149,200 *	120,800	139,200 *	95,000	120,500	79,200	104,600	28
30	77.3	115.9	129,400	137,900 *	106,400	128,600 *	83,300	106,000	69,300	91,800	30
32	76.2	115.4	115,600	128,100 *	94,700	115,500	73,900	94,400	61,300	81,500	32
34	75.2	114.8	104,200	119,500 *	85,200	104,000	66,200	84,800	54,600	73,000	34
36	74.1	114.2	94,600	111,900 *	77,200	94,400	59,700	76,700	49,100	66,000	36
38	73.0	113.6	86,500	102,500	70,300	86,200	54,200	69,900	44,400	59,900	38
40	71.9	112.9	79,500	94,400	64,500	79,200	49,500	64,000	40,300	54,800	40
45	69.1	111.0	65,600	78,200	52,800	65,300	40,100	52,400	32,300	44,500	45
50	66.3	108.8	55,300	66,200	44,200	55,000	33,100	43,800	26,300	36,900	50
55	63.3	106.3	47,400	57,000	37,500	47,100	27,700	37,100	21,700	31,100	55
60	60.4	103.5	41,100	49,700	32,200	40,800	23,400	31,900	18,000	26,400	60
65	57.3	100.3	35,900	43,700	27,900	35,600	19,900	27,500	15,000	22,600	65
70	54.1	96.7	31,600	38,800	24,300	31,400	17,000	24,000	12,500	19,500	70
75	50.7	92.7	28,000	34,600	21,300	27,800	14,500	20,900	10,400	16,800	75
80	47.2	88.2	24,900	31,000	18,600	24,700	12,400	18,300	8,600	14,500	80
85	43.5	83.0	22,200	27,900	16,400	22,000	10,500	16,100	7,000	12,500	85
90	39.4	77.1	19,800	25,100	14,400	19,600	8,900	14,100	5,600	10,800	90
95	35.0	70.2	17,700	22,700	12,600	17,500	7,500	12,300	4,300	9,200	95
100	30.0	61.9	15,900	20,500	11,000	15,600	6,200	10,800	3,200	7,800	100
105	24.0	51.6	14,100	18,600	9,600	13,900	5,000	9,300	2,200	6,500	105
110	15.8	36.7	12,500	16,700	8,200	12,300	3,800	7,900		5,300	110

S/N: 7779006

Manitowoc Cranes, Inc.

Manitowoc, Wisconsin 54220 U.S.A.



Liftcrane Boom Capacities

Meets
ANSI B30.5
Requirements

Boom No. 78T With Heavy Lift Top
0 Lb. to 95,400 Lb. Crane Counterweight
With or Without 25,000 Lb. Front Bumper Counterweight
Rating Over Rear or 360 Degrees On Fully Extended Outriggers

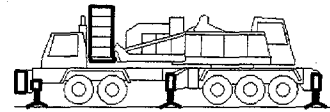

Oper. Rad. Feet	Boom Ang. Deg.	Boom Point Elev. Feet	95,400 Lb. Crane Cwt. 25,000 Lb. Bumper Cwt.		95,400 Lb. Crane Counterweight		78,400 Lb. Crane Counterweight		61,400 Lb. Crane Counterweight		Oper. Rad. Feet
			Boom Capacity 360 Deg. Pounds	Boom Capacity Rear Pounds	Boom Capacity 360 Deg. Pounds	Boom Capacity Rear Pounds	Boom Capacity 360 Deg. Pounds	Boom Capacity Rear Pounds	Boom Capacity 360 Deg. Pounds	Boom Capacity Rear Pounds	
22	82.3	127.7	189,700 *	189,700 *	189,700 *	189,700 *	189,700 *	189,700 *	189,700 *	189,700 *	22
24	81.3	127.3	178,900 *	178,900 *	178,900 *	178,900 *	178,900 *	178,900 *	178,900 *	178,900 *	24
26	80.3	127.0	169,000 *	169,000 *	169,000 *	169,000 *	169,000 *	169,000 *	169,000 *	169,000 *	26
28	79.4	126.6	160,100 *	160,100 *	160,100 *	160,100 *	160,100 *	160,100 *	159,300 *	159,300 *	28
30	78.4	126.1	152,000 *	152,000 *	152,000 *	152,000 *	152,000 *	152,000 *	147,400 *	147,400 *	30
32	77.4	125.7	144,500 *	144,500 *	144,500 *	144,500 *	144,500 *	144,500 *	136,800	136,900 *	32
34	76.4	125.2	137,700 *	137,700 *	137,700 *	137,700 *	136,000 *	136,000 *	123,500	127,800 *	34
36	75.4	124.6	131,400 *	131,400 *	131,400 *	131,400 *	127,400 *	127,400 *	112,400	119,700 *	36
38	74.4	124.0	125,500 *	125,500 *	125,500 *	125,500 *	119,100	119,800 *	103,000	112,500 *	38
40	73.4	123.4	119,900 *	119,900 *	119,900 *	119,900 *	109,800	112,900 *	94,800	106,000 *	40
45	70.9	121.7	104,700 *	104,700 *	104,300	104,700 *	91,500	98,600 *	78,700	91,500	45
50	68.4	119.7	92,600 *	92,600 *	89,000	92,600 *	77,900	87,100 *	66,800	77,800	50
55	65.7	117.5	82,800	82,800 *	77,200	82,800 *	67,400	77,200	57,500	67,300	55
60	63.1	115.0	72,800	74,600 *	67,900	74,600 *	59,000	67,800	50,200	58,900	60
65	60.3	112.2	64,800	67,800 *	60,300	67,800 *	52,200	60,200	44,200	52,100	65
70	57.5	109.0	58,000	61,900 *	53,900	61,200	46,600	53,800	39,300	46,500	70
75	54.6	105.5	52,400	56,800 *	48,600	55,300	41,800	48,500	35,100	41,700	75
80	51.6	101.6	47,500	52,300 *	44,000	50,200	37,700	43,900	31,500	37,600	80
85	48.4	97.2	43,300	48,400 *	40,000	45,800	34,200	39,900	28,400	34,100	85
90	45.0	92.3	39,600	44,900 *	36,600	42,000	31,100	36,500	25,600	31,000	90
95	41.5	86.8	36,400	41,800 *	33,500	38,600	28,400	33,400	23,200	28,200	95
100	37.6	80.5	33,500	38,900 *	30,800	35,600	25,900	30,700	21,100	25,800	100
105	33.4	73.1	30,900	36,400 *	28,300	32,900	23,700	28,200	19,200	23,600	105
110	28.6	64.4	28,600	34,000 *	26,100	30,400	21,800	26,000	17,400	21,600	110
115	22.9	53.5	26,400	31,900 *	24,100	28,200	19,900	24,000	15,800	19,800	115
120	15.1	38.0	24,400	29,800 *	22,200	26,100	18,200	22,100	14,300	18,100	120

Manitowoc Cranes, Inc.

Manitowoc, Wisconsin 54220 U.S.A.



Liftcrane Boom Capacities

Meets
ANSI B30.5
Requirements

Boom No. 78T With Heavy Lift Top
0 Lb. to 95,400 Lb. Crane Counterweight
With or Without 25,000 Lb. Front Bumper Counterweight
Rating Over Rear or 360 Degrees On Fully Extended Outriggers

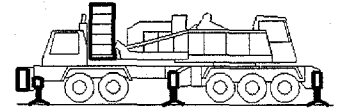

120 Ft. Boom

Oper. Rad. Feet	Boom Ang. Deg.	Boom Point Elev. Feet	44,400 Lb. Crane Counterweight		27,400 Lb. Crane Counterweight		10,400 Lb. Crane Counterweight		0 Lb. Crane Counterweight		Oper. Rad. Feet
			Boom Capacity 360 Deg. Pounds	Boom Capacity Rear Pounds	Boom Capacity 360 Deg. Pounds	Boom Capacity Rear Pounds	Boom Capacity 360 Deg. Pounds	Boom Capacity Rear Pounds	Boom Capacity 360 Deg. Pounds	Boom Capacity Rear Pounds	
22	82.3	127.7	189,700 *	189,700 *	183,300 *	183,300 *	156,700	170,400 *	132,100	162,500 *	22
24	81.3	127.3	177,800 *	177,800 *	163,800	166,000 *	129,800	154,300 *	109,200	143,000	24
26	80.3	127.0	162,400 *	162,400 *	139,600	151,600 *	110,300	139,600	92,400	121,400	26
28	79.4	126.6	147,100	149,300 *	121,300	139,300 *	95,500	121,000	79,700	105,100	28
30	78.4	126.1	129,900	138,100 *	106,800	128,700 *	83,800	106,500	69,700	92,300	30
32	77.4	125.7	116,000	128,200 *	95,200	115,900	74,400	94,800	61,700	81,900	32
34	76.4	125.2	104,600	119,600 *	85,600	104,400	66,600	85,200	55,100	73,500	34
36	75.4	124.6	95,000	112,000 *	77,500	94,800	60,100	77,100	49,500	66,400	36
38	74.4	124.0	86,800	102,900	70,700	86,600	54,600	70,300	44,800	60,300	38
40	73.4	123.4	79,800	94,700	64,800	79,600	49,800	64,400	40,700	55,100	40
45	70.9	121.7	66,000	78,600	53,200	65,600	40,400	52,700	32,600	44,900	45
50	68.4	119.7	55,700	66,600	44,500	55,300	33,400	44,100	26,600	37,300	50
55	65.7	117.5	47,700	57,300	37,900	47,400	28,000	37,500	22,000	31,400	55
60	63.1	115.0	41,400	50,000	32,500	41,100	23,700	32,200	18,300	26,700	60
65	60.3	112.2	36,200	44,000	28,200	35,900	20,200	27,900	15,300	22,900	65
70	57.5	109.0	31,900	39,100	24,600	31,700	17,300	24,300	12,800	19,800	70
75	54.6	105.5	28,300	34,900	21,600	28,100	14,800	21,200	10,700	17,100	75
80	51.6	101.6	25,200	31,300	19,000	25,000	12,700	18,700	8,900	14,800	80
85	48.4	97.2	22,500	28,200	16,700	22,300	10,900	16,400	7,300	12,800	85
90	45.0	92.3	20,200	25,500	14,700	20,000	9,200	14,400	5,900	11,100	90
95	41.5	86.8	18,100	23,100	13,000	17,900	7,800	12,700	4,700	9,500	95
100	37.6	80.5	16,200	20,900	11,400	16,000	6,500	11,100	3,600	8,200	100
105	33.4	73.1	14,600	19,000	10,000	14,400	5,400	9,700	2,600	6,900	105
110	28.6	64.4	13,000	17,200	8,700	12,800	4,300	8,500		5,800	110
115	22.9	53.5	11,600	15,600	7,500	11,400	3,300	7,300		4,700	115
120	15.1	38.0	10,300	14,100	6,300	10,100	2,400	6,100		3,700	120

Manitowoc Cranes, Inc.

Manitowoc, Wisconsin 54220 U.S.A.



Liftcrane Boom Capacities

Meets
ANSI B30.5
Requirements

Boom No. 78T With Heavy Lift Top
0 Lb. to 95,400 Lb. Crane Counterweight
With or Without 25,000 Lb. Front Bumper Counterweight
Rating Over Rear or 360 Degrees On Fully Extended Outriggers

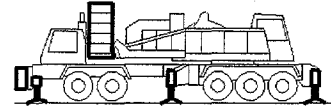

130 Ft. Boom



Oper. Rad. Feet	Boom Ang. Deg.	Boom Point Elev. Feet	95,400 Lb. Crane Cwt. 25,000 Lb. Bumper Cwt.		95,400 Lb. Crane Counterweight		78,400 Lb. Crane Counterweight		61,400 Lb. Crane Counterweight		Oper. Rad. Feet
			Boom Capacity 360 Deg. Pounds	Boom Capacity Rear Pounds	Boom Capacity 360 Deg. Pounds	Boom Capacity Rear Pounds	Boom Capacity 360 Deg. Pounds	Boom Capacity Rear Pounds	Boom Capacity 360 Deg. Pounds	Boom Capacity Rear Pounds	
22	82.9	137.8	178,100 *	178,100 *	178,100 *	178,100 *	178,100 *	178,100 *	178,100 *	178,100 *	22
24	82.0	137.5	168,900 *	168,900 *	168,900 *	168,900 *	168,900 *	168,900 *	168,900 *	168,900 *	24
26	81.1	137.1	160,500 *	160,500 *	160,500 *	160,500 *	160,500 *	160,500 *	160,500 *	160,500 *	26
28	80.2	136.8	152,700 *	152,700 *	152,700 *	152,700 *	152,700 *	152,700 *	152,700 *	152,700 *	28
30	79.3	136.4	145,700 *	145,700 *	145,700 *	145,700 *	145,700 *	145,700 *	145,700 *	145,700 *	30
32	78.4	135.9	139,100 *	139,100 *	139,100 *	139,100 *	139,100 *	139,100 *	136,600 *	136,600 *	32
34	77.5	135.5	133,000 *	133,000 *	133,000 *	133,000 *	133,000 *	133,000 *	123,600	127,500 *	34
36	76.6	135.0	126,700 *	126,700 *	126,700 *	126,700 *	126,700 *	126,700 *	112,400	119,400 *	36
38	75.7	134.4	120,900 *	120,900 *	120,900 *	120,900 *	119,100	119,400 *	103,000	112,200 *	38
40	74.8	133.9	115,500 *	115,500 *	115,500 *	115,500 *	109,800	112,600 *	94,800	105,700 *	40
45	72.5	132.3	103,700 *	103,700 *	103,700 *	103,700 *	91,400	98,200 *	78,600	91,400	45
50	70.1	130.5	92,300 *	92,300 *	88,900	92,300 *	77,800	86,800 *	66,600	77,700	50
55	67.7	128.5	82,500 *	82,500 *	77,100	82,500 *	67,200	77,100	57,400	67,100	55
60	65.3	126.2	72,700	74,300 *	67,700	74,300 *	58,900	67,700	50,000	58,700	60
65	62.8	123.6	64,600	67,400 *	60,100	67,400 *	52,100	60,000	44,000	51,900	65
70	60.3	120.8	57,800	61,500 *	53,700	61,000	46,400	53,600	39,100	46,200	70
75	57.7	117.7	52,200	56,400 *	48,400	55,100	41,600	48,300	34,900	41,500	75
80	55.0	114.2	47,300	52,000 *	43,800	50,000	37,500	43,700	31,300	37,400	80
85	52.2	110.4	43,100	48,100 *	39,800	45,600	34,000	39,700	28,200	33,800	85
90	49.4	106.2	39,400	44,600 *	36,400	41,800	30,900	36,300	25,400	30,800	90
95	46.3	101.5	36,200	41,400 *	33,300	38,400	28,200	33,200	23,000	28,000	95
100	43.1	96.2	33,300	38,600 *	30,600	35,400	25,700	30,500	20,900	25,600	100
105	39.7	90.3	30,700	36,100 *	28,100	32,700	23,500	28,000	19,000	23,400	105
110	36.1	83.7	28,400	33,800 *	25,900	30,200	21,600	25,800	17,200	21,400	110
115	32.0	76.0	26,300	31,600 *	23,900	28,000	19,800	23,800	15,600	19,700	115
120	27.4	66.8	24,300	29,700 *	22,100	26,000	18,100	22,000	14,200	18,000	120
125	21.9	55.4	22,500	27,800 *	20,400	24,100	16,600	20,300	12,800	16,500	125
130	14.4	39.1	20,800	26,100 *	18,800	22,300	15,200	18,700	11,500	15,000	130

Manitowoc Cranes, Inc.

Manitowoc, Wisconsin 54220 U.S.A.



Liftcrane Boom Capacities

Meets
ANSI B30.5
Requirements

Boom No. 78T With Heavy Lift Top
0 Lb. to 95,400 Lb. Crane Counterweight
With or Without 25,000 Lb. Front Bumper Counterweight
Rating Over Rear or 360 Degrees On Fully Extended Outriggers

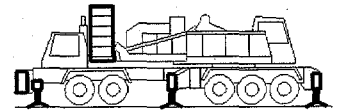

130 Ft. Boom

Oper. Rad. Feet	Boom Ang. Deg.	Boom Point Elev. Feet	44,400 Lb. Crane Counterweight		27,400 Lb. Crane Counterweight		10,400 Lb. Crane Counterweight		0 Lb. Crane Counterweight		Oper. Rad. Feet
			Boom Capacity 360 Deg. Pounds	Boom Capacity Rear Pounds	Boom Capacity 360 Deg. Pounds	Boom Capacity Rear Pounds	Boom Capacity 360 Deg. Pounds	Boom Capacity Rear Pounds	Boom Capacity 360 Deg. Pounds	Boom Capacity Rear Pounds	
22	82.9	137.8	178,100 *	178,100 *	178,100 *	178,100 *	157,300	170,100 *	132,700	162,200 *	22
24	82.0	137.5	168,900 *	168,900 *	164,200	165,700 *	130,300	154,000 *	109,600	143,500	24
26	81.1	137.1	160,500 *	160,500 *	140,000	151,300 *	110,600	139,900	92,800	121,800	26
28	80.2	136.8	147,300	147,300 *	121,500	139,000 *	95,700	121,300	80,000	105,300	28
30	79.3	136.4	130,000	137,700 *	107,000	128,400 *	83,900	106,700	69,900	92,400	30
32	78.4	135.9	116,100	127,900 *	95,300	116,000	74,500	94,900	61,800	82,100	32
34	77.5	135.5	104,600	119,300 *	85,600	104,500	66,700	85,200	55,100	73,500	34
36	76.6	135.0	95,000	111,700 *	77,600	94,800	60,100	77,100	49,500	66,400	36
38	75.7	134.4	86,800	102,900	70,700	86,600	54,600	70,300	44,800	60,300	38
40	74.8	133.9	79,800	94,700	64,800	79,500	49,800	64,400	40,700	55,100	40
45	72.5	132.3	65,900	78,500	53,100	65,600	40,300	52,700	32,500	44,800	45
50	70.1	130.5	55,500	66,400	44,400	55,200	33,300	44,000	26,500	37,100	50
55	67.7	128.5	47,500	57,200	37,700	47,200	27,800	37,300	21,800	31,200	55
60	65.3	126.2	41,200	49,800	32,400	40,900	23,500	32,000	18,100	26,600	60
65	62.8	123.6	36,000	43,800	28,000	35,700	20,000	27,700	15,100	22,700	65
70	60.3	120.8	31,700	38,900	24,400	31,500	17,100	24,100	12,600	19,600	70
75	57.7	117.7	28,100	34,700	21,400	27,800	14,600	21,000	10,500	16,900	75
80	55.0	114.2	25,000	31,100	18,700	24,800	12,500	18,400	8,700	14,600	80
85	52.2	110.4	22,300	28,000	16,500	22,100	10,600	16,200	7,100	12,600	85
90	49.4	106.2	20,000	25,200	14,500	19,700	9,000	14,200	5,700	10,900	90
95	46.3	101.5	17,900	22,800	12,700	17,700	7,600	12,500	4,500	9,300	95
100	43.1	96.2	16,000	20,700	11,200	15,800	6,300	10,900	3,400	8,000	100
105	39.7	90.3	14,400	18,800	9,800	14,200	5,200	9,500	2,400	6,700	105
110	36.1	83.7	12,900	17,100	8,500	12,700	4,100	8,300		5,600	110
115	32.0	76.0	11,500	15,500	7,300	11,300	3,200	7,100		4,600	115
120	27.4	66.8	10,200	14,000	6,300	10,000	2,300	6,100		3,600	120
125	21.9	55.4	9,000	12,700	5,300	8,900		5,100		2,700	125
130	14.4	39.1	7,900	11,400	4,300	7,700		4,100			130

Manitowoc Cranes, Inc.

Manitowoc, Wisconsin 54220 U.S.A.



Liftcrane Boom Capacities

Meets
ANSI B30.5
Requirements

Boom No. 78T With Heavy Lift Top
0 Lb. to 95,400 Lb. Crane Counterweight
With or Without 25,000 Lb. Front Bumper Counterweight
Rating Over Rear or 360 Degrees On Fully Extended Outriggers

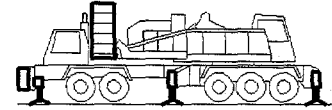

140 Ft. Boom



Oper. Rad. Feet	Boom Ang. Deg.	Boom Point Elev. Feet	95,400 Lb. Crane Cwt. 25,000 Lb. Bumper Cwt.		95,400 Lb. Crane Counterweight		78,400 Lb. Crane Counterweight		61,400 Lb. Crane Counterweight		Oper. Rad. Feet
			Boom Capacity 360 Deg. Pounds	Boom Capacity Rear Pounds	Boom Capacity 360 Deg. Pounds	Boom Capacity Rear Pounds	Boom Capacity 360 Deg. Pounds	Boom Capacity Rear Pounds	Boom Capacity 360 Deg. Pounds	Boom Capacity Rear Pounds	
24	82.6	147.6	160,600 *	160,600 *	160,600 *	160,600 *	160,600 *	160,600 *	160,600 *	160,600 *	24
26	81.7	147.3	153,300 *	153,300 *	153,300 *	153,300 *	153,300 *	153,300 *	153,300 *	153,300 *	26
28	80.9	146.9	145,700 *	145,700 *	145,700 *	145,700 *	145,700 *	145,700 *	145,700 *	145,700 *	28
30	80.1	146.6	138,700 *	138,700 *	138,700 *	138,700 *	138,700 *	138,700 *	138,700 *	138,700 *	30
32	79.2	146.2	132,200 *	132,200 *	132,200 *	132,200 *	132,200 *	132,200 *	132,200 *	132,200 *	32
34	78.4	145.7	126,200 *	126,200 *	126,200 *	126,200 *	126,200 *	126,200 *	123,600	126,200 *	34
36	77.6	145.3	120,600 *	120,600 *	120,600 *	120,600 *	120,600 *	120,600 *	112,400	119,100 *	36
38	76.7	144.8	115,000 *	115,000 *	115,000 *	115,000 *	115,000 *	115,000 *	102,900	111,900 *	38
40	75.9	144.3	109,800 *	109,800 *	109,800 *	109,800 *	109,700	109,800 *	94,700	105,400 *	40
45	73.7	142.8	98,300 *	98,300 *	98,300 *	98,300 *	91,300	97,900 *	78,500	91,300	45
50	71.6	141.2	88,700 *	88,700 *	88,700 *	88,700 *	77,600	86,500 *	66,500	77,600	50
55	69.4	139.3	80,400 *	80,400 *	76,900	80,400 *	67,100	76,900	57,200	67,000	55
60	67.2	137.2	72,500	72,500	67,500	73,200 *	58,700	67,500	49,900	58,600	60
65	64.9	134.9	64,400	66,900 *	59,900	66,900 *	51,900	59,800	43,900	51,700	65
70	62.6	132.3	57,600	61,200 *	53,500	60,800	46,200	53,500	38,900	46,100	70
75	60.3	129.5	52,000	56,100 *	48,200	54,900	41,400	48,100	34,700	41,300	75
80	57.9	126.4	47,100	51,700 *	43,600	49,800	37,300	43,500	31,100	37,200	80
85	55.4	122.9	42,900	47,800 *	39,600	45,400	33,800	39,500	27,900	33,600	85
90	52.8	119.2	39,200	44,300 *	36,200	41,600	30,700	36,100	25,200	30,500	90
95	50.2	115.1	36,000	41,200 *	33,100	38,200	28,000	33,000	22,800	27,800	95
100	47.4	110.5	33,100	38,400 *	30,400	35,200	25,500	30,300	20,700	25,400	100
105	44.5	105.5	30,500	35,700 *	27,900	32,500	23,300	27,800	18,800	23,200	105
110	41.5	100.0	28,200	33,300 *	25,700	30,000	21,400	25,600	17,000	21,300	110
115	38.2	93.8	26,100	31,000 *	23,800	27,800	19,600	23,700	15,500	19,500	115
120	34.7	86.8	24,200	28,900 *	21,900	25,800	18,000	21,800	14,000	17,900	120
125	30.8	78.7	22,400	26,900 *	20,300	24,000	16,500	20,200	12,700	16,400	125
130	26.4	69.1	20,800	25,100 *	18,700	22,300	15,100	18,600	11,500	15,000	130
135	21.1	57.2	19,200	23,400 *	17,300	20,700	13,800	17,200	10,300	13,700	135
140	13.9	40.3	17,800	21,800 *	15,900	19,200	12,600	15,800	9,200	12,500	140

S/N: 7779006



777T

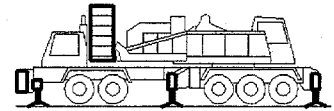

Liftcrane Boom Capacities

Meets
ANSI B30.5
Requirements

Boom No. 78T With Heavy Lift Top
0 Lb. to 95,400 Lb. Crane Counterweight
With or Without 25,000 Lb. Front Bumper Counterweight
Rating Over Rear or 360 Degrees On Fully Extended Outriggers

140 Ft. Boom

Oper. Rad. Feet	Boom Ang. Deg.	Boom Point Elev. Feet	44,400 Lb. Crane Counterweight		27,400 Lb. Crane Counterweight		10,400 Lb. Crane Counterweight		Oper. Rad. Feet
			Boom Capacity 360 Deg. Pounds	Boom Capacity Rear Pounds	Boom Capacity 360 Deg. Pounds	Boom Capacity Rear Pounds	Boom Capacity 360 Deg. Pounds	Boom Capacity Rear Pounds	
24	82.6	147.6	160,600 *	160,600 *	160,600 *	160,600 *	130,600	153,700 *	24
26	81.7	147.3	153,300 *	153,300 *	140,200	151,000 *	110,900	140,200 *	26
28	80.9	146.9	145,700 *	145,700 *	121,600	138,700 *	95,800	121,500	28
30	80.1	146.6	130,100	137,400 *	107,100	128,100 *	84,000	106,800	30
32	79.2	146.2	116,200	127,600 *	95,300	116,100	74,500	95,000	32
34	78.4	145.7	104,600	119,000 *	85,700	104,500	66,700	85,300	34
36	77.6	145.3	95,000	111,400 *	77,600	94,800	60,100	77,100	36
38	76.7	144.8	86,800	102,900	70,700	86,600	54,500	70,200	38
40	75.9	144.3	79,700	94,600	64,700	79,500	49,700	64,300	40
45	73.7	142.8	65,800	78,400	53,000	65,500	40,200	52,600	45
50	71.6	141.2	55,400	66,300	44,300	55,100	33,100	43,900	50
55	69.4	139.3	47,400	57,000	37,500	47,100	27,700	37,100	55
60	67.2	137.2	41,000	49,700	32,200	40,700	23,400	31,800	60
65	64.9	134.9	35,800	43,600	27,800	35,600	19,800	27,500	65
70	62.6	132.3	31,500	38,700	24,200	31,300	16,900	23,900	70
75	60.3	129.5	27,900	34,500	21,200	27,700	14,400	20,800	75
80	57.9	126.4	24,800	30,900	18,500	24,600	12,300	18,200	80
85	55.4	122.9	22,100	27,800	16,300	21,900	10,400	16,000	85
90	52.8	119.2	19,800	25,000	14,300	19,500	8,800	14,000	90
95	50.2	115.1	17,700	22,600	12,500	17,500	7,400	12,300	95
100	47.4	110.5	15,800	20,500	11,000	15,600	6,100	10,700	100
105	44.5	105.5	14,200	18,600	9,600	14,000	5,000	9,300	105
110	41.5	100.0	12,700	16,900	8,300	12,500	3,900	8,100	110
115	38.2	93.8	11,300	15,300	7,200	11,100	3,000	6,900	115
120	34.7	86.8	10,100	13,900	6,100	9,900	2,100	5,900	120
125	30.8	78.7	8,900	12,600	5,100	8,700		4,900	125
130	26.4	69.1	7,900	11,300	4,200	7,700		4,000	130
135	21.1	57.2	6,800	10,200	3,400	6,700		3,200	135
140	13.9	40.3	5,900	9,100	2,500	5,700		2,400	140

Manitowoc Cranes, Inc.

Manitowoc, Wisconsin 54220 U.S.A.



777T

Liftcrane Boom Capacities

Meets
ANSI B30.5
Requirements

Boom No. 78T With Heavy Lift Top
0 Lb. to 95,400 Lb. Crane Counterweight
With or Without 25,000 Lb. Front Bumper Counterweight
Rating Over Rear or 360 Degrees On Fully Extended Outriggers

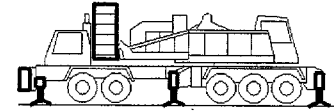

150 Ft. Boom



Oper. Rad. Feet	Boom Ang. Deg.	Boom Point Elev. Feet	95,400 Lb. Crane Cwt. 25,000 Lb. Bumper Cwt.		95,400 Lb. Crane Counterweight		78,400 Lb. Crane Counterweight		61,400 Lb. Crane Counterweight		Oper. Rad. Feet
			Boom Capacity 360 Deg. Pounds	Boom Capacity Rear Pounds	Boom Capacity 360 Deg. Pounds	Boom Capacity Rear Pounds	Boom Capacity 360 Deg. Pounds	Boom Capacity Rear Pounds	Boom Capacity 360 Deg. Pounds	Boom Capacity Rear Pounds	
26	82.3	157.4	161,100 *	161,100 *	161,100 *	161,100 *	161,100 *	161,100 *	161,100 *	161,100 *	26
28	81.5	157.1	155,100 *	155,100 *	155,100 *	155,100 *	155,100 *	155,100 *	155,100 *	155,100 *	28
30	80.7	156.7	148,000 *	148,000 *	148,000 *	148,000 *	148,000 *	148,000 *	146,200 *	146,200 *	30
32	80.0	156.4	138,900 *	138,900 *	138,900 *	138,900 *	138,900 *	138,900 *	135,700 *	135,700 *	32
34	79.2	156.0	130,900 *	130,900 *	130,900 *	130,900 *	130,900 *	130,900 *	123,600 *	126,600 *	34
36	78.4	155.5	123,900 *	123,900 *	123,900 *	123,900 *	123,900 *	123,900 *	112,300 *	118,500 *	36
38	77.6	155.1	117,600 *	117,600 *	117,600 *	117,600 *	117,600 *	117,600 *	102,800 *	111,300 *	38
40	76.8	154.6	112,000 *	112,000 *	112,000 *	112,000 *	109,500 *	111,700 *	94,500 *	104,800 *	40
45	74.9	153.2	100,200 *	100,200 *	100,200 *	100,200 *	91,000 *	97,300 *	78,200 *	91,000 *	45
50	72.9	151.7	90,700 *	90,700 *	88,400 *	90,700 *	77,300 *	85,800 *	66,200 *	77,200 *	50
55	70.8	150.0	81,500 *	81,500 *	76,500 *	81,500 *	66,700 *	76,500 *	56,800 *	66,600 *	55
60	68.8	148.1	72,000 *	73,300 *	67,100 *	73,300 *	58,300 *	67,100 *	49,400 *	58,100 *	60
65	66.7	145.9	63,900 *	66,500 *	59,400 *	66,500 *	51,400 *	59,400 *	43,400 *	51,300 *	65
70	64.6	143.6	57,100 *	60,600 *	53,000 *	60,400 *	45,700 *	53,000 *	38,400 *	45,600 *	70
75	62.5	141.0	51,400 *	55,500 *	47,700 *	54,400 *	40,900 *	47,600 *	34,100 *	40,800 *	75
80	60.3	138.1	46,600 *	51,000 *	43,100 *	49,300 *	36,800 *	43,000 *	30,500 *	36,700 *	80
85	58.0	135.0	42,300 *	47,100 *	39,100 *	44,900 *	33,200 *	39,000 *	27,400 *	33,100 *	85
90	55.7	131.7	38,700 *	43,600 *	35,600 *	41,000 *	30,100 *	35,500 *	24,700 *	30,000 *	90
95	53.3	128.0	35,400 *	40,500 *	32,500 *	37,600 *	27,400 *	32,400 *	22,200 *	27,300 *	95
100	50.9	123.9	32,500 *	37,700 *	29,800 *	34,600 *	25,000 *	29,700 *	20,100 *	24,800 *	100
105	48.3	119.6	29,900 *	35,200 *	27,400 *	31,900 *	22,800 *	27,300 *	18,200 *	22,600 *	105
110	45.7	114.7	27,600 *	32,800 *	25,200 *	29,500 *	20,800 *	25,100 *	16,400 *	20,700 *	110
115	42.9	109.5	25,500 *	30,700 *	23,200 *	27,300 *	19,000 *	23,100 *	14,900 *	18,900 *	115
120	40.0	103.6	23,600 *	28,800 *	21,400 *	25,300 *	17,400 *	21,300 *	13,400 *	17,300 *	120
125	36.8	97.1	21,800 *	27,000 *	19,700 *	23,400 *	15,900 *	19,600 *	12,100 *	15,800 *	125
130	33.4	89.7	20,200 *	25,400 *	18,200 *	21,700 *	14,500 *	18,100 *	10,900 *	14,400 *	130
135	29.7	81.3	18,700 *	23,800 *	16,800 *	20,200 *	13,300 *	16,700 *	9,800 *	13,200 *	135
140	25.4	71.3	17,300 *	22,400 *	15,400 *	18,700 *	12,100 *	15,400 *	8,700 *	12,000 *	140
145	20.3	58.9	16,000 *	21,000 *	14,200 *	17,300 *	11,000 *	14,100 *	7,800 *	10,900 *	145
150	13.4	41.4	14,700 *	18,900 *	13,000 *	16,000 *	9,900 *	12,900 *	6,800 *	9,800 *	150

Manitowoc Cranes, Inc.

Manitowoc, Wisconsin 54220 U.S.A.



777T

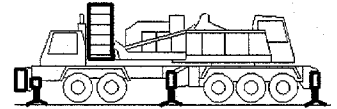

Liftcrane Boom Capacities

Boom No. 78T With Heavy Lift Top
 0 Lb. to 95,400 Lb. Crane Counterweight
 With or Without 25,000 Lb. Front Bumper Counterweight
 Rating Over Rear or 360 Degrees On Fully Extended Outriggers

Meets
 ANSI B30.5
 Requirements

150 Ft. Boom

Oper. Rad. Feet	Boom Ang. Deg.	Boom Point Elev. Feet	44,400 Lb. Crane Counterweight		27,400 Lb. Crane Counterweight		Oper. Rad. Feet
			Boom Capacity 360 Deg. Pounds	Boom Capacity Rear Pounds	Boom Capacity 360 Deg. Pounds	Boom Capacity Rear Pounds	
			26	82.3	157.4	161,100 *	
28	81.5	157.1	147,700	148,200 *	121,900	138,200 *	28
30	80.7	156.7	130,200	136,900 *	107,200	127,600 *	30
32	80.0	156.4	116,200	127,000 *	95,400	116,100	32
34	79.2	156.0	104,600	118,400 *	85,600	104,500	34
36	78.4	155.5	94,900	110,800 *	77,500	94,700	36
38	77.6	155.1	86,600	102,700	70,500	86,400	38
40	76.8	154.6	79,500	94,500	64,500	79,300	40
45	74.9	153.2	65,500	78,100	52,700	65,200	45
50	72.9	151.7	55,000	66,000	43,900	54,700	50
55	70.8	150.0	47,000	56,600	37,100	46,700	55
60	68.8	148.1	40,600	49,200	31,700	40,300	60
65	66.7	145.9	35,400	43,200	27,400	35,100	65
70	64.6	143.6	31,000	38,200	23,700	30,800	70
75	62.5	141.0	27,400	34,000	20,600	27,100	75
80	60.3	138.1	24,300	30,300	18,000	24,000	80
85	58.0	135.0	21,600	27,200	15,700	21,300	85
90	55.7	131.7	19,200	24,500	13,700	19,000	90
95	53.3	128.0	17,100	22,100	12,000	16,900	95
100	50.9	123.9	15,300	19,900	10,400	15,000	100
105	48.3	119.6	13,600	18,000	9,000	13,400	105
110	45.7	114.7	12,100	16,300	7,700	11,900	110
115	42.9	109.5	10,700	14,700	6,600	10,500	115
120	40.0	103.6	9,500	13,300	5,500	9,300	120
125	36.8	97.1	8,300	12,000	4,600	8,200	125
130	33.4	89.7	7,300	10,800	3,700	7,100	130
135	29.7	81.3	6,300	9,700	2,800	6,200	135
140	25.4	71.3	5,400	8,600	2,100	5,300	140
145	20.3	58.9	4,500	7,600		4,400	145
150	13.4	41.4	3,700	6,700		3,500	150

S/N: 7779006

Manitowoc Cranes, Inc.

Manitowoc, Wisconsin 54220 U.S.A.



Liftcrane Boom Capacities

Meets
ANSI B30.5
Requirements

Boom No. 78T With Heavy Lift Top
0 Lb. to 95,400 Lb. Crane Counterweight
With or Without 25,000 Lb. Front Bumper Counterweight
Rating Over Rear or 360 Degrees On Fully Extended Outriggers

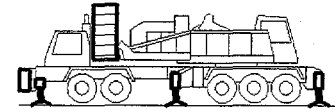

160 Ft. Boom



Oper. Rad. Feet	Boom Ang. Deg.	Boom Point Elev. Feet	95,400 Lb. Crane Cwt. 25,000 Lb. Bumper Cwt.		95,400 Lb. Crane Counterweight		78,400 Lb. Crane Counterweight		61,400 Lb. Crane Counterweight		Oper. Rad. Feet
			Boom Capacity 360 Deg. Pounds	Boom Capacity Rear Pounds	Boom Capacity 360 Deg. Pounds	Boom Capacity Rear Pounds	Boom Capacity 360 Deg. Pounds	Boom Capacity Rear Pounds	Boom Capacity 360 Deg. Pounds	Boom Capacity Rear Pounds	
26	82.8	167.5	155,900 *	155,900 *	155,900 *	155,900 *	155,900 *	155,900 *	155,900 *	155,900 *	26
28	82.1	167.2	150,500 *	150,500 *	150,500 *	150,500 *	150,500 *	150,500 *	150,500 *	150,500 *	28
30	81.3	166.9	145,000 *	145,000 *	145,000 *	145,000 *	145,000 *	145,000 *	145,000 *	145,000 *	30
32	80.6	166.5	136,000 *	136,000 *	136,000 *	136,000 *	136,000 *	136,000 *	135,400 *	135,400 *	32
34	79.9	166.2	128,100 *	128,100 *	128,100 *	128,100 *	128,100 *	128,100 *	123,500	126,200 *	34
36	79.1	165.8	121,100 *	121,100 *	121,100 *	121,100 *	121,100 *	121,100 *	112,200	118,100 *	36
38	78.4	165.3	115,000 *	115,000 *	115,000 *	115,000 *	115,000 *	115,000 *	102,600	110,900 *	38
40	77.7	164.9	109,400 *	109,400 *	109,400 *	109,400 *	109,400 *	109,400 *	94,400	104,400 *	40
45	75.8	163.6	97,800 *	97,800 *	97,800 *	97,800 *	90,800	96,900 *	78,100	90,800	45
50	74.0	162.2	88,500 *	88,500 *	88,200	88,500 *	77,100	85,500 *	65,900	77,000	50
55	72.1	160.6	80,900 *	80,900 *	76,300	80,900 *	66,400	76,200 *	56,600	66,300	55
60	70.2	158.8	71,800	73,000 *	66,800	73,000 *	58,000	66,800	49,200	57,900	60
65	68.3	156.8	63,600	66,100 *	59,200	66,100 *	51,100	59,100	43,100	51,000	65
70	66.3	154.6	56,900	60,200 *	52,800	60,100	45,400	52,700	38,100	45,300	70
75	64.3	152.2	51,200	55,100 *	47,400	54,100	40,600	47,300	33,900	40,500	75
80	62.3	149.6	46,300	50,700 *	42,800	49,000	36,500	42,700	30,300	36,400	80
85	60.2	146.8	42,100	46,800 *	38,800	44,600	33,000	38,700	27,100	32,800	85
90	58.1	143.7	38,400	43,300 *	35,300	40,700	29,800	35,200	24,400	29,700	90
95	56.0	140.4	35,100	40,200 *	32,200	37,300	27,100	32,200	22,000	27,000	95
100	53.8	136.7	32,200	37,400 *	29,500	34,300	24,700	29,400	19,800	24,500	100
105	51.5	132.8	29,700	34,800 *	27,100	31,600	22,500	27,000	17,900	22,400	105
110	49.1	128.5	27,300	32,500 *	24,900	29,200	20,500	24,800	16,200	20,400	110
115	46.7	123.9	25,200	30,400 *	22,900	27,000	18,800	22,800	14,600	18,600	115
120	44.1	118.8	23,300	28,500 *	21,100	25,000	17,100	21,000	13,200	17,000	120
125	41.5	113.2	21,600	26,700 *	19,400	23,200	15,700	19,300	11,900	15,500	125
130	38.6	107.1	19,900	25,100 *	17,900	21,500	14,300	17,800	10,700	14,200	130
135	35.6	100.3	18,500	23,500 *	16,500	19,900	13,000	16,400	9,600	12,900	135
140	32.3	92.6	17,100	22,100 *	15,200	18,500	11,900	15,100	8,500	11,800	140
145	28.7	83.8	15,800	20,800 *	14,000	17,200	10,800	13,900	7,600	10,700	145
150	24.6	73.5	14,600	19,500 *	12,900	15,900	9,800	12,800	6,700	9,700	150
155	19.6	60.6	13,500	18,300 *	11,800	14,700	8,800	11,700	5,800	8,700	155
160	12.9	42.5	12,300	16,000 *	10,700	13,600	7,800	10,600	4,900	7,700	160

Manitowoc Cranes, Inc.

Manitowoc, Wisconsin 54220 U.S.A.



777T

Liftcrane Boom Capacities

Boom No. 78T With Heavy Lift Top
 0 Lb. to 95,400 Lb. Crane Counterweight
 With or Without 25,000 Lb. Front Bumper Counterweight
 Rating Over Rear or 360 Degrees On Fully Extended Outriggers

Meets
ANSI B30.5
Requirements

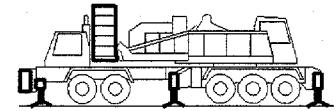

160 Ft. Boom

Oper. Rad. Feet	Boom Ang. Deg.	Boom Point Elev. Feet	44,400 Lb. Crane Counterweight		27,400 Lb. Crane Counterweight		Oper. Rad. Feet
			Boom Capacity 360 Deg. Pounds	Boom Capacity Rear Pounds	Boom Capacity 360 Deg. Pounds	Boom Capacity Rear Pounds	
26	82.8	167.5	155,900 *	155,900 *	140,600	150,100 *	26
28	82.1	167.2	147,700	147,800 *	121,900	137,800 *	28
30	81.3	166.9	130,200	136,500 *	107,200	127,200 *	30
32	80.6	166.5	116,100	126,700 *	95,300	116,000	32
34	79.9	166.2	104,500	118,100 *	85,500	104,400	34
36	79.1	165.8	94,800	110,400 *	77,300	94,600	36
38	78.4	165.3	86,500	102,600	70,400	86,300	38
40	77.7	164.9	79,400	94,300	64,400	79,100	40
45	75.8	163.6	65,300	77,900	52,500	65,000	45
50	74.0	162.2	54,800	65,800	43,700	54,500	50
55	72.1	160.6	46,800	56,400	36,900	46,500	55
60	70.2	158.8	40,300	49,000	31,500	40,100	60
65	68.3	156.8	35,100	42,900	27,100	34,800	65
70	66.3	154.6	30,800	37,900	23,400	30,500	70
75	64.3	152.2	27,100	33,700	20,400	26,900	75
80	62.3	149.6	24,000	30,100	17,700	23,700	80
85	60.2	146.8	21,300	26,900	15,400	21,100	85
90	58.1	143.7	18,900	24,200	13,400	18,700	90
95	56.0	140.4	16,800	21,800	11,700	16,600	95
100	53.8	136.7	15,000	19,700	10,100	14,800	100
105	51.5	132.8	13,300	17,700	8,700	13,100	105
110	49.1	128.5	11,800	16,000	7,500	11,600	110
115	46.7	123.9	10,500	14,500	6,300	10,300	115
120	44.1	118.8	9,200	13,000	5,300	9,000	120
125	41.5	113.2	8,100	11,700	4,300	7,900	125
130	38.6	107.1	7,000	10,500	3,400	6,900	130
135	35.6	100.3	6,100	9,400	2,600	5,900	135
140	32.3	92.6	5,200	8,400		5,000	140
145	28.7	83.8	4,300	7,400		4,200	145
150	24.6	73.5	3,600	6,500		3,400	150
155	19.6	60.6	2,800	5,700		2,700	155
160	12.9	42.5	2,000	4,800			160

S/N: 7779006

Manitowoc Cranes, Inc.

Manitowoc, Wisconsin 54220 U.S.A.



Liftcrane Boom Capacities

Meets
ANSI B30.5
Requirements

Boom No. 78T With Heavy Lift Top
0 Lb. to 95,400 Lb. Crane Counterweight
With or Without 25,000 Lb. Front Bumper Counterweight
Rating Over Rear or 360 Degrees On Fully Extended Outriggers

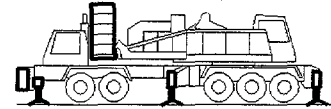

170 Ft. Boom



Oper. Rad. Feet	Boom Ang. Deg.	Boom Point Elev. Feet	95,400 Lb. Crane Cwt. 25,000 Lb. Bumper Cwt.		95,400 Lb. Crane Counterweight		78,400 Lb. Crane Counterweight		61,400 Lb. Crane Counterweight		Oper. Rad. Feet
			Boom Capacity 360 Deg. Pounds	Boom Capacity Rear Pounds	Boom Capacity 360 Deg. Pounds	Boom Capacity Rear Pounds	Boom Capacity 360 Deg. Pounds	Boom Capacity Rear Pounds	Boom Capacity 360 Deg. Pounds	Boom Capacity Rear Pounds	
28	82.5	177.3	147,500 *	147,500 *	147,500 *	147,500 *	147,500 *	147,500 *	147,500 *	147,500 *	28
30	81.8	177.0	142,300 *	142,300 *	142,300 *	142,300 *	142,300 *	142,300 *	142,300 *	142,300 *	30
32	81.2	176.7	133,300 *	133,300 *	133,300 *	133,300 *	133,300 *	133,300 *	133,300 *	133,300 *	32
34	80.5	176.3	125,500 *	125,500 *	125,500 *	125,500 *	125,500 *	125,500 *	123,500 *	125,500 *	34
36	79.8	176.0	118,600 *	118,600 *	118,600 *	118,600 *	118,600 *	118,600 *	112,200 *	118,100 *	36
38	79.1	175.6	112,400 *	112,400 *	112,400 *	112,400 *	112,400 *	112,400 *	102,600 *	110,800 *	38
40	78.4	175.1	106,900 *	106,900 *	106,900 *	106,900 *	106,900 *	106,900 *	94,400 *	104,400 *	40
45	76.7	174.0	95,400 *	95,400 *	95,400 *	95,400 *	90,800 *	95,400 *	78,000 *	90,800 *	45
50	74.9	172.6	86,200 *	86,200 *	86,200 *	86,200 *	77,000 *	85,400 *	65,900 *	77,000 *	50
55	73.2	171.1	78,700 *	78,700 *	76,300 *	78,700 *	66,400 *	76,100 *	56,600 *	66,300 *	55
60	71.4	169.4	71,800 *	72,400 *	66,800 *	72,400 *	58,000 *	66,800 *	49,200 *	57,900 *	60
65	69.6	167.6	63,600 *	66,000 *	59,100 *	66,000 *	51,100 *	59,100 *	43,100 *	51,000 *	65
70	67.8	165.6	56,900 *	60,200 *	52,700 *	60,100 *	45,400 *	52,700 *	38,100 *	45,300 *	70
75	65.9	163.3	51,100 *	55,100 *	47,400 *	54,100 *	40,600 *	47,300 *	33,800 *	40,500 *	75
80	64.1	160.9	46,300 *	50,600 *	42,800 *	49,000 *	36,500 *	42,700 *	30,200 *	36,400 *	80
85	62.2	158.3	42,000 *	46,700 *	38,800 *	44,600 *	32,900 *	38,700 *	27,100 *	32,800 *	85
90	60.2	155.5	38,400 *	43,200 *	35,300 *	40,700 *	29,800 *	35,200 *	24,400 *	29,700 *	90
95	58.3	152.4	35,100 *	40,100 *	32,200 *	37,300 *	27,100 *	32,100 *	21,900 *	27,000 *	95
100	56.2	149.1	32,200 *	37,300 *	29,500 *	34,300 *	24,700 *	29,400 *	19,800 *	24,500 *	100
105	54.2	145.5	29,600 *	34,800 *	27,100 *	31,600 *	22,500 *	27,000 *	17,900 *	22,300 *	105
110	52.0	141.6	27,300 *	32,500 *	24,900 *	29,200 *	20,500 *	24,800 *	16,200 *	20,400 *	110
115	49.8	137.4	25,200 *	30,400 *	22,900 *	27,000 *	18,700 *	22,800 *	14,600 *	18,600 *	115
120	47.6	132.9	23,300 *	28,500 *	21,100 *	25,000 *	17,100 *	21,000 *	13,200 *	17,000 *	120
125	45.2	128.0	21,600 *	26,700 *	19,400 *	23,200 *	15,700 *	19,300 *	11,900 *	15,500 *	125
130	42.7	122.7	20,000 *	25,000 *	17,900 *	21,500 *	14,300 *	17,800 *	10,700 *	14,200 *	130
135	40.1	116.8	18,500 *	23,500 *	16,500 *	19,900 *	13,000 *	16,400 *	9,600 *	12,900 *	135
140	37.4	110.4	17,100 *	22,100 *	15,200 *	18,500 *	11,900 *	15,200 *	8,500 *	11,800 *	140
145	34.5	103.3	15,800 *	20,800 *	14,000 *	17,200 *	10,800 *	14,000 *	7,600 *	10,700 *	145
150	31.3	95.4	14,600 *	19,500 *	12,900 *	16,000 *	9,800 *	12,800 *	6,700 *	9,700 *	150
155	27.8	86.2	13,500 *	18,400 *	11,900 *	14,800 *	8,900 *	11,800 *	5,900 *	8,800 *	155
160	23.8	75.5	12,500 *	17,300 *	10,900 *	13,700 *	8,000 *	10,800 *	5,100 *	7,900 *	160
165	19.0	62.2	11,500 *	16,200 *	9,900 *	12,700 *	7,100 *	9,800 *	4,300 *	7,000 *	165
170	12.5	43.5	10,500 *	13,700 *	9,000 *	11,700 *	6,300 *	8,900 *	3,600 *	6,200 *	170

Manitowoc Cranes, Inc.

Manitowoc, Wisconsin 54220 U.S.A.



777T

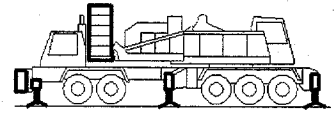

Liftcrane Boom Capacities

Boom No. 78T With Heavy Lift Top
 0 Lb. to 95,400 Lb. Crane Counterweight
 With or Without 25,000 Lb. Front Bumper Counterweight
 Rating Over Rear or 360 Degrees On Fully Extended Outriggers

Meets
 ANSI B30.5
 Requirements

170 Ft. Boom



Oper. Rad. Feet	Boom Ang. Deg.	Boom Point Elev. Feet	44,400 Lb. Crane Counterweight	
			Boom Capacity 360 Deg. Pounds	Boom Capacity Rear Pounds
28	82.5	177.3	147,500 *	147,500 *
30	81.8	177.0	130,200	136,400 *
32	81.2	176.7	116,100	126,600 *
34	80.5	176.3	104,500	118,000 *
36	79.8	176.0	94,800	110,400 *
38	79.1	175.6	86,500	102,600
40	78.4	175.1	79,400	94,300
45	76.7	174.0	65,300	77,900
50	74.9	172.6	54,800	65,700
55	73.2	171.1	46,700	56,400
60	71.4	169.4	40,300	49,000
65	69.6	167.6	35,100	42,900
70	67.8	165.6	30,800	37,900
75	65.9	163.3	27,100	33,700
80	64.1	160.9	24,000	30,000
85	62.2	158.3	21,300	26,900
90	60.2	155.5	18,900	24,200
95	58.3	152.4	16,800	21,800
100	56.2	149.1	15,000	19,600
105	54.2	145.5	13,300	17,700
110	52.0	141.6	11,800	16,000
115	49.8	137.4	10,400	14,400
120	47.6	132.9	9,200	13,000
125	45.2	128.0	8,100	11,700
130	42.7	122.7	7,000	10,500
135	40.1	116.8	6,100	9,400
140	37.4	110.4	5,200	8,400
145	34.5	103.3	4,400	7,500
150	31.3	95.4	3,600	6,600
155	27.8	86.2	2,900	5,800
160	23.8	75.5	2,200	5,000
165	19.0	62.2		4,200
170	12.5	43.5		3,500

Manitowoc Cranes, Inc.

Manitowoc, Wisconsin 54220 U.S.A.



Liftcrane Boom Capacities

Meets
ANSI B30.5
Requirements

Boom No. 78T With Heavy Lift Top
0 Lb. to 95,400 Lb. Crane Counterweight
With or Without 25,000 Lb. Front Bumper Counterweight
Rating Over Rear or 360 Degrees On Fully Extended Outriggers

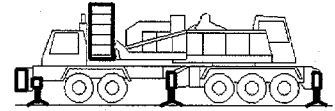

180 Ft. Boom



Oper. Rad. Feet	Boom Ang. Deg.	Boom Point Elev. Feet	95,400 Lb. Crane Cwt. 25,000 Lb. Bumper Cwt.		95,400 Lb. Crane Counterweight		78,400 Lb. Crane Counterweight		61,400 Lb. Crane Counterweight		Oper. Rad. Feet
			Boom Capacity 360 Deg. Pounds	Boom Capacity Rear Pounds	Boom Capacity 360 Deg. Pounds	Boom Capacity Rear Pounds	Boom Capacity 360 Deg. Pounds	Boom Capacity Rear Pounds	Boom Capacity 360 Deg. Pounds	Boom Capacity Rear Pounds	
28	82.9	187.4	133,400 *	133,400 *	133,400 *	133,400 *	133,400 *	133,400 *	133,400 *	133,400 *	28
30	82.3	187.1	129,000 *	129,000 *	129,000 *	129,000 *	129,000 *	129,000 *	129,000 *	129,000 *	30
32	81.7	186.8	124,900 *	124,900 *	124,900 *	124,900 *	124,900 *	124,900 *	124,900 *	124,900 *	32
34	81.0	186.5	120,900 *	120,900 *	120,900 *	120,900 *	120,900 *	120,900 *	120,900 *	120,900 *	34
36	80.4	186.1	115,700 *	115,700 *	115,700 *	115,700 *	115,700 *	115,700 *	112,200	115,700 *	36
38	79.7	185.8	109,700 *	109,700 *	109,700 *	109,700 *	109,700 *	109,700 *	102,500	109,700 *	38
40	79.1	185.4	104,300 *	104,300 *	104,300 *	104,300 *	104,300 *	104,300 *	94,300	104,000 *	40
45	77.4	184.3	92,900 *	92,900 *	92,900 *	92,900 *	90,600	92,900 *	77,900	90,300 *	45
50	75.8	183.0	83,800 *	83,800 *	83,800 *	83,800 *	76,800	83,800 *	65,700	76,800	50
55	74.1	181.6	76,500 *	76,500 *	76,000	76,500 *	66,200	75,700 *	56,300	66,100	55
60	72.5	180.0	70,300 *	70,300 *	66,600	70,300 *	57,700	66,500	48,900	57,600	60
65	70.8	178.3	63,300	65,000 *	58,800	65,000 *	50,800	58,800	42,800	50,700	65
70	69.1	176.4	56,500	59,700 *	52,400	59,700 *	45,100	52,400	37,800	45,000	70
75	67.4	174.3	50,800	54,600 *	47,000	53,800	40,300	47,000	33,500	40,100	75
80	65.6	172.0	45,900	50,200 *	42,400	48,700	36,200	42,300	29,900	36,000	80
85	63.8	169.6	41,700	46,300 *	38,400	44,200	32,600	38,300	26,800	32,500	85
90	62.1	167.0	38,000	42,800 *	34,900	40,400	29,500	34,900	24,000	29,300	90
95	60.2	164.1	34,700	39,700 *	31,900	37,000	26,700	31,800	21,600	26,600	95
100	58.4	161.0	31,900	36,900 *	29,100	33,900	24,300	29,000	19,400	24,200	100
105	56.4	157.8	29,300	34,400 *	26,700	31,200	22,100	26,600	17,500	22,000	105
110	54.5	154.2	26,900	32,100 *	24,500	28,800	20,100	24,400	15,800	20,000	110
115	52.5	150.4	24,800	30,000 *	22,500	26,600	18,400	22,400	14,200	18,300	115
120	50.4	146.3	22,900	28,000 *	20,700	24,600	16,800	20,600	12,800	16,600	120
125	48.3	141.9	21,200	26,300 *	19,100	22,800	15,300	19,000	11,500	15,200	125
130	46.1	137.2	19,600	24,600 *	17,500	21,100	13,900	17,500	10,300	13,800	130
135	43.8	132.0	18,100	23,100 *	16,200	19,600	12,700	16,100	9,200	12,600	135
140	41.5	126.4	16,700	21,700 *	14,900	18,100	11,500	14,800	8,200	11,400	140
145	39.0	120.4	15,500	20,400 *	13,700	16,800	10,400	13,600	7,200	10,300	145
150	36.3	113.7	14,300	19,100 *	12,500	15,600	9,400	12,500	6,300	9,300	150
155	33.5	106.3	13,200	18,000 *	11,500	14,400	8,500	11,400	5,500	8,400	155
160	30.4	98.0	12,100	16,900 *	10,500	13,400	7,600	10,500	4,700	7,500	160
165	27.0	88.6	11,200	15,900 *	9,600	12,300	6,800	9,500	4,000	6,700	165
170	23.1	77.5	10,200	14,800 *	8,700	11,400	6,000	8,700	3,300	5,900	170
175	18.5	63.8	9,400	13,600 *	7,900	10,500	5,300	7,800	2,600	5,200	175
180	12.1	44.5	8,500	11,300 *	7,100	9,600	4,500	7,000	2,000	4,400	180

Manitowoc Cranes, Inc.

Manitowoc, Wisconsin 54220 U.S.A.



777T

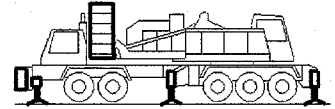

Liftcrane Boom Capacities

Boom No. 78T With Heavy Lift Top
 0 Lb. to 95,400 Lb. Crane Counterweight
 With or Without 25,000 Lb. Front Bumper Counterweight
 Rating Over Rear or 360 Degrees On Fully Extended Outriggers

Meets
 ANSI B30.5
 Requirements

180 Ft. Boom



Oper. Rad. Feet	Boom Ang. Deg.	Boom Point Elev. Feet	44,400 Lb. Crane Counterweight	
			Boom Capacity 360 Deg. Pounds	Boom Capacity Rear Pounds
28	82.9	187.4	133,400 *	133,400 *
30	82.3	187.1	129,000 *	129,000 *
32	81.7	186.8	116,200	124,900 *
34	81.0	186.5	104,500	117,600 *
36	80.4	186.1	94,700	110,000 *
38	79.7	185.8	86,400	102,500
40	79.1	185.4	79,300	94,200
45	77.4	184.3	65,100	77,700
50	75.8	183.0	54,600	65,500
55	74.1	181.6	46,500	56,100
60	72.5	180.0	40,000	48,700
65	70.8	178.3	34,800	42,600
70	69.1	176.4	30,400	37,600
75	67.4	174.3	26,800	33,300
80	65.6	172.0	23,600	29,700
85	63.8	169.6	20,900	26,600
90	62.1	167.0	18,500	23,800
95	60.2	164.1	16,400	21,400
100	58.4	161.0	14,600	19,300
105	56.4	157.8	12,900	17,400
110	54.5	154.2	11,400	15,600
115	52.5	150.4	10,100	14,100
120	50.4	146.3	8,800	12,700
125	48.3	141.9	7,700	11,400
130	46.1	137.2	6,700	10,200
135	43.8	132.0	5,700	9,100
140	41.5	126.4	4,800	8,100
145	39.0	120.4	4,000	7,100
150	36.3	113.7	3,200	6,200
155	33.5	106.3	2,500	5,400
160	30.4	98.0		4,600
165	27.0	88.6		3,900
170	23.1	77.5		3,200
175	18.5	63.8		2,500

S/N: 7779006

Manitowoc Cranes, Inc.

Manitowoc, Wisconsin 54220 U.S.A.



Liftcrane Boom Capacities

Meets
ANSI B30.5
Requirements

Boom No. 78T With Heavy Lift Top
0 Lb. to 95,400 Lb. Crane Counterweight
With or Without 25,000 Lb. Front Bumper Counterweight
Rating Over Rear or 360 Degrees On Fully Extended Outriggers

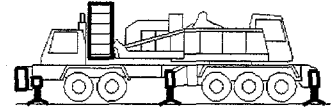

190 Ft. Boom



Oper. Rad. Feet	Boom Ang. Deg.	Boom Point Elev. Feet	95,400 Lb. Crane Cwt. 25,000 Lb. Bumper Cwt.		95,400 Lb. Crane Counterweight		78,400 Lb. Crane Counterweight		61,400 Lb. Crane Counterweight		Oper. Rad. Feet
			Boom Capacity 360 Deg. Pounds	Boom Capacity Rear Pounds	Boom Capacity 360 Deg. Pounds	Boom Capacity Rear Pounds	Boom Capacity 360 Deg. Pounds	Boom Capacity Rear Pounds	Boom Capacity 360 Deg. Pounds	Boom Capacity Rear Pounds	
30	82.7	197.2	121,100 *	121,100 *	121,100 *	121,100 *	121,100 *	121,100 *	121,100 *	121,100 *	30
32	82.1	196.9	116,900 *	116,900 *	116,900 *	116,900 *	116,900 *	116,900 *	116,900 *	116,900 *	32
34	81.5	196.6	112,900 *	112,900 *	112,900 *	112,900 *	112,900 *	112,900 *	112,900 *	112,900 *	34
36	80.9	196.3	109,100 *	109,100 *	109,100 *	109,100 *	109,100 *	109,100 *	109,100 *	109,100 *	36
38	80.3	195.9	105,500 *	105,500 *	105,500 *	105,500 *	105,500 *	105,500 *	102,400	105,500 *	38
40	79.7	195.6	101,500 *	101,500 *	101,500 *	101,500 *	101,500 *	101,500 *	94,100	101,500 *	40
45	78.1	194.5	90,400 *	90,400 *	90,400 *	90,400 *	90,400 *	90,400 *	77,700	90,000 *	45
50	76.6	193.3	81,500 *	81,500 *	81,500 *	81,500 *	76,600	81,500 *	65,500	76,500	50
55	75.0	192.0	74,200 *	74,200 *	74,200 *	74,200 *	65,900	74,200 *	56,100	65,800	55
60	73.4	190.5	68,100 *	68,100 *	66,300	68,100 *	57,400	66,300	48,600	57,300	60
65	71.8	188.9	62,900 *	62,900 *	58,600	62,900 *	50,500	58,500	42,500	50,400	65
70	70.2	187.1	56,200	58,400 *	52,100	58,400 *	44,800	52,100	37,500	44,700	70
75	68.6	185.1	50,500	54,200 *	46,700	53,500	40,000	46,700	33,200	39,800	75
80	67.0	183.0	45,600	49,800 *	42,100	48,300	35,800	42,000	29,600	35,700	80
85	65.3	180.7	41,400	45,900 *	38,100	43,900	32,300	38,000	26,400	32,100	85
90	63.6	178.3	37,700	42,400 *	34,600	40,000	29,100	34,500	23,700	29,000	90
95	61.9	175.6	34,400	39,300 *	31,500	36,600	26,400	31,400	21,300	26,300	95
100	60.2	172.8	31,500	36,500 *	28,800	33,600	23,900	28,700	19,100	23,800	100
105	58.4	169.7	28,900	34,000 *	26,400	30,900	21,800	26,300	17,200	21,600	105
110	56.6	166.4	26,600	31,700 *	24,200	28,500	19,800	24,100	15,400	19,700	110
115	54.8	162.9	24,500	29,600 *	22,200	26,300	18,000	22,100	13,900	17,900	115
120	52.9	159.2	22,600	27,600 *	20,400	24,300	16,400	20,300	12,400	16,300	120
125	51.0	155.2	20,800	25,900 *	18,700	22,400	14,900	18,600	11,100	14,800	125
130	49.0	150.9	19,200	24,200 *	17,200	20,800	13,600	17,100	9,900	13,500	130
135	46.9	146.2	17,800	22,700 *	15,800	19,200	12,300	15,700	8,800	12,200	135
140	44.8	141.3	16,400	21,300 *	14,500	17,800	11,200	14,400	7,800	11,100	140
145	42.6	135.9	15,100	20,000 *	13,300	16,500	10,100	13,200	6,900	10,000	145
150	40.3	130.1	13,900	18,800 *	12,200	15,300	9,100	12,100	6,000	9,000	150
155	37.9	123.8	12,800	17,600 *	11,200	14,100	8,200	11,100	5,200	8,100	155
160	35.3	116.8	11,800	16,500 *	10,200	13,000	7,300	10,100	4,400	7,200	160
165	32.5	109.2	10,800	15,500 *	9,300	12,000	6,500	9,200	3,700	6,400	165
170	29.5	100.6	9,900	14,400 *	8,400	11,100	5,700	8,300	3,000	5,600	170
175	26.2	90.9	9,100	13,200 *	7,600	10,200	5,000	7,500	2,300	4,900	175
180	22.5	79.5	8,300	12,000 *	6,800	9,300	4,300	6,800		4,200	180
185	17.9	65.3	7,500	10,900 *	6,100	8,500	3,600	6,000		3,500	185
190	11.8	45.5	6,700	9,100 *	5,300	7,700	2,900	5,300		2,800	190



777T

Liftcrane Boom Capacities

Meets
ANSI B30.5
Requirements

Boom No. 78T With Heavy Lift Top
0 Lb. to 95,400 Lb. Crane Counterweight
With or Without 25,000 Lb. Front Bumper Counterweight
Rating Over Rear or 360 Degrees On Fully Extended Outriggers

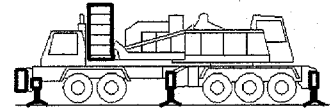

200 Ft. Boom



Oper. Rad. Feet	Boom Ang. Deg.	Boom Point Elev. Feet	95,400 Lb. Crane Cwt. 25,000 Lb. Bumper Cwt.		95,400 Lb. Crane Counterweight		78,400 Lb. Crane Counterweight		61,400 Lb. Crane Counterweight		Oper. Rad. Feet
			Boom Capacity 360 Deg. Pounds	Boom Capacity Rear Pounds	Boom Capacity 360 Deg. Pounds	Boom Capacity Rear Pounds	Boom Capacity 360 Deg. Pounds	Boom Capacity Rear Pounds	Boom Capacity 360 Deg. Pounds	Boom Capacity Rear Pounds	
32	82.5	207.1	105,900 *	105,900 *	105,900 *	105,900 *	105,900 *	105,900 *	105,900 *	105,900 *	32
34	81.9	206.8	102,400 *	102,400 *	102,400 *	102,400 *	102,400 *	102,400 *	102,400 *	102,400 *	34
36	81.3	206.4	99,000 *	99,000 *	99,000 *	99,000 *	99,000 *	99,000 *	99,000 *	99,000 *	36
38	80.8	206.1	95,800 *	95,800 *	95,800 *	95,800 *	95,800 *	95,800 *	95,800 *	95,800 *	38
40	80.2	205.7	92,700 *	92,700 *	92,700 *	92,700 *	92,700 *	92,700 *	92,700 *	92,700 *	40
45	78.7	204.7	85,400 *	85,400 *	85,400 *	85,400 *	85,400 *	85,400 *	77,500	85,400 *	45
50	77.2	203.6	78,600 *	78,600 *	78,600 *	78,600 *	76,400	78,600 *	65,200	76,300	50
55	75.8	202.4	72,200 *	72,200 *	72,200 *	72,200 *	65,700	72,200 *	55,800	65,600	55
60	74.3	201.0	66,300 *	66,300 *	66,000	66,300 *	57,100	66,000	48,300	57,000	60
65	72.8	199.4	61,100 *	61,100 *	58,200	61,100 *	50,200	58,200	42,200	50,100	65
70	71.3	197.7	55,900	56,300 *	51,800	56,300 *	44,500	51,700	37,100	44,300	70
75	69.7	195.9	50,200	52,100 *	46,400	52,100 *	39,600	46,300	32,900	39,500	75
80	68.2	193.9	45,200	48,200 *	41,700	48,000	35,500	41,700	29,200	35,300	80
85	66.6	191.7	41,000	44,600 *	37,700	43,500	31,900	37,600	26,100	31,800	85
90	65.1	189.4	37,300	41,300 *	34,200	39,700	28,800	34,100	23,300	28,600	90
95	63.5	186.9	34,000	38,200 *	31,100	36,200	26,000	31,100	20,900	25,900	95
100	61.8	184.3	31,100	35,400 *	28,400	33,200	23,600	28,300	18,700	23,400	100
105	60.2	181.4	28,500	32,800 *	26,000	30,500	21,400	25,900	16,800	21,200	105
110	58.5	178.4	26,200	30,400 *	23,800	28,100	19,400	23,700	15,000	19,300	110
115	56.8	175.1	24,100	28,100 *	21,800	25,900	17,600	21,700	13,500	17,500	115
120	55.1	171.7	22,200	26,000 *	20,000	23,900	16,000	19,900	12,000	15,900	120
125	53.3	168.0	20,400	24,000 *	18,300	22,000	14,500	18,200	10,700	14,400	125
130	51.5	164.0	18,800	22,100 *	16,800	20,400	13,200	16,700	9,500	13,100	130
135	49.6	159.8	17,300	20,300 *	15,400	18,800	11,900	15,300	8,400	11,800	135
140	47.7	155.3	16,000	18,700 *	14,100	17,400	10,800	14,000	7,400	10,700	140
145	45.7	150.4	14,700	17,100 *	12,900	16,100	9,700	12,800	6,500	9,600	145
150	43.6	145.3	13,500	15,600 *	11,800	14,800	8,700	11,700	5,600	8,600	150
155	41.5	139.7	12,400	14,200 *	10,800	13,700	7,800	10,700	4,800	7,700	155
160	39.2	133.6	11,400	12,900 *	9,800	12,600	6,900	9,700	4,000	6,800	160
165	36.8	127.1	10,400	11,600 *	8,900	11,600	6,100	8,800	3,300	6,000	165
170	34.3	119.9	9,500	10,400 *	8,000	10,400 *	5,300	7,900	2,600	5,200	170
175	31.7	112.0	8,700	9,300 *	7,200	9,300 *	4,600	7,100	2,000	4,500	175
180	28.8	103.2	7,900	8,200 *	6,400	8,200 *	3,900	6,400		3,800	180
185	25.5	93.1	7,100	7,200 *	5,700	7,200 *	3,200	5,600		3,200	185
190	21.9	81.4	6,200 *	6,200 *	5,000	6,200 *	2,600	4,900		2,500	190
195	17.5	66.8	5,300 *	5,300 *	4,300	5,300 *	2,000	4,300			195
200	11.4	46.4	4,400 *	4,400 *	3,700	4,400 *		3,600			200

Manitowoc Cranes, Inc.

Manitowoc, Wisconsin 54220 U.S.A.



Liftcrane Boom Capacities

Meets
ANSI B30.5
Requirements

Boom No. 78T With Heavy Lift Top
0 Lb. to 95,400 Lb. Crane Counterweight
With or Without 25,000 Lb. Front Bumper Counterweight
Rating Over Rear or 360 Degrees On Fully Extended Outriggers

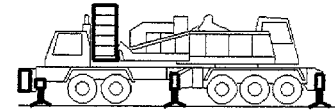

210 Ft. Boom

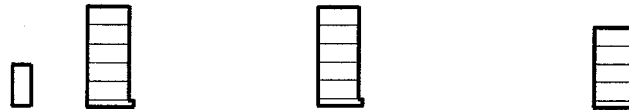

Oper. Rad. Feet	Boom Ang. Deg.	Boom Point Elev. Feet	95,400 Lb. Crane Cwt. 25,000 Lb. Bumper Cwt.		95,400 Lb. Crane Counterweight		78,400 Lb. Crane Counterweight		Oper. Rad. Feet
			Boom Capacity 360 Deg. Pounds	Boom Capacity Rear Pounds	Boom Capacity 360 Deg. Pounds	Boom Capacity Rear Pounds	Boom Capacity 360 Deg. Pounds	Boom Capacity Rear Pounds	
32	82.9	217.2	109,100 *	109,100 *	109,100 *	109,100 *	109,100 *	109,100 *	32
34	82.3	216.9	106,100 *	106,100 *	106,100 *	106,100 *	106,100 *	106,100 *	34
36	81.8	216.6	103,200 *	103,200 *	103,200 *	103,200 *	103,200 *	103,200 *	36
38	81.2	216.2	100,400 *	100,400 *	100,400 *	100,400 *	100,400 *	100,400 *	38
40	80.7	215.9	97,700 *	97,700 *	97,700 *	97,700 *	97,700 *	97,700 *	40
45	79.3	215.0	87,500 *	87,500 *	87,500 *	87,500 *	87,500 *	87,500 *	45
50	77.9	213.9	78,700 *	78,700 *	78,700 *	78,700 *	76,100	78,700 *	50
55	76.5	212.7	71,500 *	71,500 *	71,500 *	71,500 *	65,400	71,500 *	55
60	75.1	211.4	65,500 *	65,500 *	65,500 *	65,500 *	56,900	65,500 *	60
65	73.6	209.9	60,400 *	60,400 *	58,000	60,400 *	50,000	57,900	65
70	72.2	208.3	55,700	56,000 *	51,600	56,000 *	44,200	51,500	70
75	70.8	206.6	49,900	52,000 *	46,100	52,000 *	39,400	46,100	75
80	69.3	204.7	45,000	48,500 *	41,500	47,700	35,200	41,400	80
85	67.8	202.6	40,700	45,100 *	37,500	43,300	31,600	37,400	85
90	66.3	200.5	37,000	41,600 *	34,000	39,400	28,500	33,900	90
95	64.8	198.1	33,800	38,500 *	30,900	36,000	25,700	30,800	95
100	63.3	195.6	30,900	35,700 *	28,200	33,000	23,300	28,100	100
105	61.8	192.9	28,300	33,200 *	25,700	30,200	21,100	25,600	105
110	60.2	190.1	25,900	30,900 *	23,500	27,800	19,100	23,400	110
115	58.6	187.1	23,800	28,800 *	21,500	25,600	17,400	21,400	115
120	57.0	183.8	21,900	26,900 *	19,700	23,600	15,700	19,600	120
125	55.3	180.4	20,200	25,100 *	18,000	21,800	14,300	18,000	125
130	53.6	176.7	18,600	23,500 *	16,500	20,100	12,900	16,500	130
135	51.9	172.8	17,100	22,000 *	15,100	18,600	11,700	15,100	135
140	50.1	168.7	15,700	20,600 *	13,900	17,100	10,500	13,800	140
145	48.3	164.3	14,500	19,300 *	12,700	15,800	9,400	12,600	145
150	46.4	159.6	13,300	18,100 *	11,600	14,600	8,400	11,500	150
155	44.5	154.5	12,200	16,900 *	10,500	13,500	7,500	10,400	155
160	42.5	149.1	11,200	15,700 *	9,600	12,400	6,700	9,500	160
165	40.4	143.3	10,200	14,600 *	8,600	11,400	5,800	8,600	165
170	38.2	137.1	9,300	13,500 *	7,800	10,500	5,100	7,700	170
175	35.9	130.3	8,500	12,500 *	7,000	9,600	4,400	6,900	175
180	33.5	122.9	7,700	11,600 *	6,200	8,700	3,700	6,200	180
185	30.9	114.7	6,900	10,600 *	5,500	7,900	3,000	5,400	185
190	28.0	105.6	6,200	9,800 *	4,800	7,200	2,400	4,800	190
195	24.9	95.3	5,500	8,900 *	4,200	6,500		4,100	195
200	21.3	83.2	4,800	8,100 *	3,600	5,800		3,500	200
205	17.0	68.3	4,200	7,000 *	2,900	5,100		2,900	205
210	11.2	47.3	3,600	5,200 *	2,300	4,500		2,300	210

Manitowoc Cranes, Inc.

Manitowoc, Wisconsin 54220 U.S.A.



777T

Liftcrane Boom Capacities

Boom No. 78T With Heavy Lift Top
 0 Lb. to 95,400 Lb. Crane Counterweight
 With or Without 25,000 Lb. Front Bumper Counterweight
 Rating Over Rear or 360 Degrees On Fully Extended Outriggers

Meets
 ANSI B30.5
 Requirements

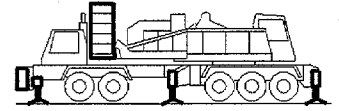

220 Ft. Boom

Oper. Rad. Feet	Boom Ang. Deg.	Boom Point Elev. Feet	95,400 Lb. Crane Cwt. 25,000 Lb. Bumper Cwt.		95,400 Lb. Crane Counterweight		78,400 Lb. Crane Counterweight		Oper. Rad. Feet
			Boom Capacity 360 Deg. Pounds	Boom Capacity Rear Pounds	Boom Capacity 360 Deg. Pounds	Boom Capacity Rear Pounds	Boom Capacity 360 Deg. Pounds	Boom Capacity Rear Pounds	
34	82.7	227.0	111,100 *	111,100 *	111,100 *	111,100 *	111,100 *	111,100 *	34
36	82.1	226.7	107,600 *	107,600 *	107,600 *	107,600 *	107,600 *	107,600 *	36
38	81.6	226.4	101,700 *	101,700 *	101,700 *	101,700 *	101,700 *	101,700 *	38
40	81.1	226.0	96,400 *	96,400 *	96,400 *	96,400 *	96,400 *	96,400 *	40
45	79.8	225.1	85,300 *	85,300 *	85,300 *	85,300 *	85,300 *	85,300 *	45
50	78.4	224.1	76,600 *	76,600 *	76,600 *	76,600 *	76,000	76,600 *	50
55	77.1	223.0	69,400 *	69,400 *	69,400 *	69,400 *	65,300	69,400 *	55
60	75.7	221.7	63,500 *	63,500 *	63,500 *	63,500 *	56,800	63,500 *	60
65	74.4	220.3	58,500 *	58,500 *	57,800	58,500 *	49,800	57,800	65
70	73.0	218.8	54,200 *	54,200 *	51,400	54,200 *	44,100	51,300	70
75	71.7	217.2	49,800	50,400 *	46,000	50,400 *	39,200	45,900	75
80	70.3	215.4	44,800	47,000 *	41,300	47,000 *	35,100	41,300	80
85	68.9	213.4	40,600	44,100 *	37,300	43,100	31,500	37,200	85
90	67.5	211.4	36,900	41,400 *	33,800	39,200	28,400	33,700	90
95	66.1	209.2	33,600	38,400 *	30,700	35,800	25,600	30,600	95
100	64.6	206.8	30,700	35,600 *	28,000	32,800	23,100	27,900	100
105	63.2	204.3	28,100	33,000 *	25,500	30,100	21,000	25,500	105
110	61.7	201.6	25,800	30,700 *	23,300	27,600	19,000	23,300	110
115	60.2	198.8	23,700	28,700 *	21,400	25,400	17,200	21,300	115
120	58.7	195.7	21,800	26,700 *	19,500	23,400	15,600	19,500	120
125	57.1	192.5	20,000	25,000 *	17,900	21,600	14,100	17,800	125
130	55.5	189.1	18,400	23,300 *	16,400	19,900	12,800	16,300	130
135	53.9	185.5	16,900	21,800 *	15,000	18,400	11,500	14,900	135
140	52.3	181.6	15,600	20,400 *	13,700	17,000	10,400	13,600	140
145	50.6	177.6	14,300	19,100 *	12,500	15,700	9,300	12,400	145
150	48.9	173.2	13,100	17,900 *	11,400	14,400	8,300	11,300	150
155	47.1	168.6	12,000	16,700 *	10,400	13,300	7,400	10,300	155
160	45.3	163.7	11,000	15,500 *	9,400	12,200	6,500	9,300	160
165	43.4	158.5	10,100	14,400 *	8,500	11,200	5,700	8,400	165
170	41.4	152.9	9,200	13,300 *	7,600	10,300	4,900	7,600	170
175	39.4	146.9	8,300	12,300 *	6,900	9,400	4,200	6,800	175
180	37.3	140.4	7,500	11,400 *	6,100	8,600	3,500	6,000	180
185	35.0	133.4	6,800	10,500 *	5,400	7,800	2,900	5,300	185
190	32.7	125.8	6,100	9,600 *	4,700	7,100	2,300	4,600	190
195	30.1	117.4	5,400	8,800 *	4,100	6,400		4,000	195
200	27.4	108.0	4,700	8,000 *	3,400	5,700		3,400	200
205	24.3	97.4	4,100	7,300 *	2,900	5,000		2,800	205
210	20.8	85.0	3,500	6,500 *	2,300	4,400		2,200	210
215	16.6	69.7	2,900	5,400 *		3,800			215
220	10.9	48.2	2,300	3,700 *		3,200			220

Manitowoc Cranes, Inc.

Manitowoc, Wisconsin 54220 U.S.A.



777T

Liftcrane Boom Capacities

Meets
ANSI B30.5
Requirements

Boom No. 78T With Heavy Lift Top
0 Lb. to 95,400 Lb. Crane Counterweight
With or Without 25,000 Lb. Front Bumper Counterweight
Rating Over Rear or 360 Degrees On Fully Extended Outriggers

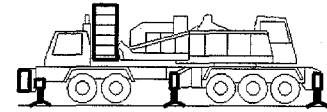

230 Ft. Boom

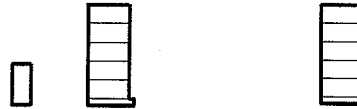

Oper. Rad. Feet	Boom Ang. Deg.	Boom Point Elev. Feet	95,400 Lb. Crane Cwt. 25,000 Lb. Bumper Cwt.		95,400 Lb. Crane Counterweight		Oper. Rad. Feet
			Boom Capacity 360 Deg. Pounds	Boom Capacity Rear Pounds	Boom Capacity 360 Deg. Pounds	Boom Capacity Rear Pounds	
34	83.0	237.1	99,500 *	99,500 *	99,500 *	99,500 *	34
36	82.5	236.8	97,200 *	97,200 *	97,200 *	97,200 *	36
38	82.0	236.5	94,800 *	94,800 *	94,800 *	94,800 *	38
40	81.5	236.2	92,600 *	92,600 *	92,600 *	92,600 *	40
45	80.2	235.3	83,300 *	83,300 *	83,300 *	83,300 *	45
50	78.9	234.3	74,700 *	74,700 *	74,700 *	74,700 *	50
55	77.7	233.3	67,600 *	67,600 *	67,600 *	67,600 *	55
60	76.4	232.0	61,800 *	61,800 *	61,800 *	61,800 *	60
65	75.1	230.7	56,800 *	56,800 *	56,800 *	56,800 *	65
70	73.8	229.3	52,500 *	52,500 *	51,100	52,500 *	70
75	72.5	227.7	48,800 *	48,800 *	45,600	48,800 *	75
80	71.2	226.0	44,500	45,500 *	41,000	45,500 *	80
85	69.8	224.2	40,200	42,600 *	37,000	42,600 *	85
90	68.5	222.2	36,500	40,000 *	33,400	38,900	90
95	67.2	220.1	33,200	37,500 *	30,300	35,400	95
100	65.8	217.9	30,300	35,100 *	27,600	32,400	100
105	64.4	215.5	27,700	32,600 *	25,100	29,700	105
110	63.0	213.0	25,400	30,300 *	22,900	27,200	110
115	61.6	210.3	23,300	28,200 *	20,900	25,000	115
120	60.2	207.4	21,300	26,300 *	19,100	23,000	120
125	58.7	204.4	19,600	24,500 *	17,500	21,200	125
130	57.2	201.2	18,000	22,900 *	16,000	19,500	130
135	55.7	197.8	16,500	21,400 *	14,600	18,000	135
140	54.2	194.2	15,100	20,000 *	13,300	16,600	140
145	52.6	190.4	13,900	18,600 *	12,100	15,200	145
150	51.0	186.4	12,700	17,300 *	11,000	14,000	150
155	49.4	182.2	11,600	16,000 *	9,900	12,900	155
160	47.7	177.6	10,600	14,800 *	9,000	11,800	160
165	46.0	172.9	9,600	13,700 *	8,100	10,800	165
170	44.2	167.8	8,700	12,600 *	7,200	9,900	170
175	42.4	162.4	7,900	11,400 *	6,400	9,000	175
180	40.5	156.6	7,100	10,300 *	5,700	8,200	180
185	38.5	150.4	6,300	9,200 *	5,000	7,400	185
190	36.4	143.7	5,600	8,300 *	4,300	6,600	190
195	34.2	136.5	4,900	7,300 *	3,600	5,900	195
200	31.9	128.6	4,300	6,400 *	3,000	5,300	200
205	29.4	120.0	3,700	5,500 *	2,400	4,600	205
210	26.7	110.4	3,100	4,700 *		4,000	210
215	23.7	99.5	2,500	3,800 *		3,400	215
220	20.3	86.8	2,000	3,100 *		2,900	220
225	16.2	71.1		2,300 *		2,300	225

S/N: 7779006



Liftcrane Boom Capacities

Meets
ANSI B30.5
Requirements

Boom No. 78T With Heavy Lift Top
0 Lb. to 95,400 Lb. Crane Counterweight
With or Without 25,000 Lb. Front Bumper Counterweight
Rating Over Rear or 360 Degrees On Fully Extended Outriggers

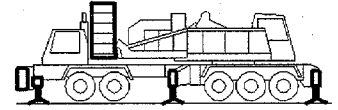

240 Ft. Boom



Oper. Rad. Feet	Boom Ang. Deg.	Boom Point Elev. Feet	95,400 Lb. Crane Cwt. 25,000 Lb. Bumper Cwt.		95,400 Lb. Crane Counterweight		Oper. Rad. Feet
			Boom Capacity 360 Deg. Pounds	Boom Capacity Rear Pounds	Boom Capacity 360 Deg. Pounds	Boom Capacity Rear Pounds	
36	82.8	246.9	88,300 *	88,300 *	88,300 *	88,300 *	36
38	82.3	246.6	86,100 *	86,100 *	86,100 *	86,100 *	38
40	81.8	246.3	83,800 *	83,800 *	83,800 *	83,800 *	40
45	80.6	245.5	78,600 *	78,600 *	78,600 *	78,600 *	45
50	79.4	244.5	73,000 *	73,000 *	73,000 *	73,000 *	50
55	78.2	243.5	66,000 *	66,000 *	66,000 *	66,000 *	55
60	77.0	242.4	60,200 *	60,200 *	60,200 *	60,200 *	60
65	75.7	241.1	55,200 *	55,200 *	55,200 *	55,200 *	65
70	74.5	239.7	51,000 *	51,000 *	50,700	51,000 *	70
75	73.2	238.2	47,300 *	47,300 *	45,300	47,300 *	75
80	72.0	236.6	44,000 *	44,000 *	40,600	44,000 *	80
85	70.7	234.8	39,900	41,200 *	36,600	41,200 *	85
90	69.5	233.0	36,100	38,600 *	33,100	38,500	90
95	68.2	231.0	32,800	36,200 *	30,000	35,100	95
100	66.9	228.8	29,900	34,000 *	27,200	32,000	100
105	65.6	226.6	27,300	31,600 *	24,800	29,300	105
110	64.2	224.2	25,000	29,100 *	22,500	26,900	110
115	62.9	221.6	22,900	26,800 *	20,500	24,600	115
120	61.5	218.9	20,900	24,700 *	18,700	22,600	120
125	60.2	216.1	19,200	22,700 *	17,100	20,800	125
130	58.8	213.1	17,600	20,900 *	15,600	19,100	130
135	57.4	209.9	16,100	19,100 *	14,200	17,600	135
140	55.9	206.5	14,700	17,500 *	12,900	16,200	140
145	54.5	202.9	13,500	16,000 *	11,700	14,800	145
150	53.0	199.2	12,300	14,500 *	10,600	13,600	150
155	51.4	195.2	11,200	13,200 *	9,500	12,500	155
160	49.9	191.1	10,200	11,900 *	8,600	11,400	160
165	48.3	186.6	9,200	10,600 *	7,700	10,400	165
170	46.7	182.0	8,300	9,500 *	6,800	9,500 *	170
175	45.0	177.0	7,500	8,300 *	6,000	8,300 *	175
180	43.2	171.7	6,700	7,300 *	5,300	7,300 *	180
185	41.4	166.1	5,900	6,300 *	4,500	6,300 *	185
190	39.6	160.2	5,200	5,300 *	3,900	5,300 *	190
195	37.6	153.8	4,400 *	4,400 *	3,200	4,400 *	195
200	35.6	146.9	3,500 *	3,500 *	2,600	3,500 *	200
205	33.5	139.5	2,600 *	2,600 *	2,000	2,600 *	205

Manitowoc Cranes, Inc.

Manitowoc, Wisconsin 54220 U.S.A.



777T

Liftcrane Boom Capacities

Meets
ANSI B30.5
Requirements

Boom No. 78T With Heavy Lift Top
0 Lb. to 95,400 Lb. Crane Counterweight
With or Without 25,000 Lb. Front Bumper Counterweight
Rating Over Rear or 360 Degrees On Fully Extended Outriggers

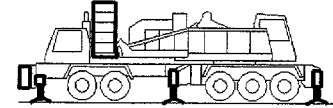

250 Ft. Boom



Oper. Rad. Feet	Boom Ang. Deg.	Boom Point Elev. Feet	95,400 Lb. Crane Cwt. 25,000 Lb. Bumper Cwt.	
			Boom Capacity 360 Deg. Pounds	Boom Capacity Rear Pounds
38	82.6	256.7	88,500 *	88,500 *
40	82.2	256.4	86,900 *	86,900 *
45	81.0	255.6	80,600 *	80,600 *
50	79.8	254.7	71,900 *	71,900 *
55	78.7	253.7	64,900 *	64,900 *
60	77.5	252.6	59,000 *	59,000 *
65	76.3	251.4	54,100 *	54,100 *
70	75.1	250.1	49,800 *	49,800 *
75	73.9	248.7	46,200 *	46,200 *
80	72.7	247.1	42,900 *	42,900 *
85	71.5	245.4	39,400	40,000 *
90	70.3	243.7	35,700	37,500 *
95	69.1	241.7	32,400	35,100 *
100	67.8	239.7	29,500	32,900 *
105	66.6	237.6	26,800	30,900 *
110	65.3	235.3	24,500	29,000 *
115	64.1	232.9	22,400	27,200 *
120	62.8	230.3	20,500	25,300 *
125	61.5	227.6	18,700	23,600 *
130	60.2	224.7	17,100	21,900 *
135	58.8	221.7	15,600	20,400 *
140	57.5	218.5	14,200	18,900 *
145	56.1	215.2	13,000	17,500 *
150	54.7	211.7	11,800	16,100 *
155	53.3	208.0	10,700	14,900 *
160	51.8	204.1	9,700	13,700 *
165	50.3	199.9	8,700	12,600 *
170	48.8	195.6	7,800	11,600 *
175	47.2	191.0	7,000	10,600 *
180	45.6	186.2	6,200	9,700 *
185	44.0	181.0	5,400	8,800 *
190	42.3	175.6	4,700	7,900 *
195	40.6	169.8	4,100	7,100 *
200	38.7	163.7	3,400	6,300 *
205	36.9	157.1	2,800	5,600 *
210	34.9	150.0	2,200	4,900 *
215	32.8	142.4		4,200 *
220	30.6	134.1		3,600 *
225	28.2	125.0		3,000 *
230	25.6	114.9		2,400 *

Manitowoc Cranes, Inc.

Manitowoc, Wisconsin 54220 U.S.A.



777T

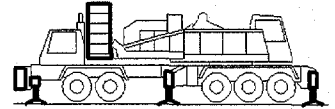

Liftcrane Boom Capacities

Meets
ANSI B30.5
Requirements

Boom No. 78T With Heavy Lift Top
0 Lb. to 95,400 Lb. Crane Counterweight
With or Without 25,000 Lb. Front Bumper Counterweight
Rating Over Rear or 360 Degrees On Fully Extended Outriggers

260 Ft. Boom



Oper. Rad. Feet	Boom Ang. Deg.	Boom Point Elev. Feet	95,400 Lb. Crane Cwt. 25,000 Lb. Bumper Cwt.	
			Boom Capacity 360 Deg. Pounds	Boom Capacity Rear Pounds
38	82.9	266.8	81,400 *	81,400 *
40	82.5	266.5	79,700 *	79,700 *
45	81.3	265.8	75,600 *	75,600 *
50	80.2	264.9	70,300 *	70,300 *
55	79.1	263.9	63,400 *	63,400 *
60	78.0	262.9	57,600 *	57,600 *
65	76.9	261.7	52,700 *	52,700 *
70	75.7	260.4	48,500 *	48,500 *
75	74.6	259.1	44,900 *	44,900 *
80	73.4	257.6	41,700 *	41,700 *
85	72.3	256.0	38,900 *	38,900 *
90	71.1	254.3	35,300	36,300 *
95	69.9	252.5	32,000	33,900 *
100	68.7	250.5	29,100	31,700 *
105	67.6	248.5	26,500	29,700 *
110	66.4	246.3	24,100	27,900 *
115	65.1	244.0	22,000	26,200 *
120	63.9	241.5	20,100	24,600 *
125	62.7	239.0	18,300	23,100 *
130	61.4	236.2	16,700	21,300 *
135	60.2	233.4	15,200	19,600 *
140	58.9	230.4	13,800	18,100 *
145	57.6	227.2	12,600	16,600 *
150	56.2	223.9	11,400	15,300 *
155	54.9	220.4	10,300	14,100 *
160	53.5	216.7	9,300	12,900 *
165	52.1	212.9	8,300	11,800 *
170	50.7	208.8	7,400	10,800 *
175	49.3	204.5	6,600	9,800 *
180	47.8	200.0	5,800	8,900 *
185	46.3	195.3	5,000	8,000 *
190	44.7	190.3	4,300	7,200 *
195	43.1	185.0	3,700	6,400 *
200	41.4	179.4	3,000	5,700 *
205	39.7	173.4	2,400	5,000 *
210	38.0	167.1		4,300 *
215	36.1	160.3		3,500 *
220	34.2	153.1		2,600 *

S/N: 7779006

Manitowoc Cranes, Inc.

Manitowoc, Wisconsin 54220 U.S.A.



Liftcrane Boom Capacities

Meets
ANSI B30.5
Requirements

Boom No. 78T With Heavy Lift Top
0 Lb. to 95,400 Lb. Crane Counterweight
With or Without 25,000 Lb. Front Bumper Counterweight
Rating Over Rear or 360 Degrees On Fully Extended Outriggers

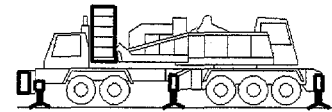

270 Ft. Boom



Oper. Rad. Feet	Boom Ang. Deg.	Boom Point Elev. Feet	95,400 Lb. Crane Cwt. 25,000 Lb. Bumper Cwt.	
			Boom Capacity 360 Deg. Pounds	Boom Capacity Rear Pounds
40	82.7	276.6	77,500 *	77,500 *
45	81.7	275.9	73,900 *	73,900 *
50	80.6	275.1	68,700 *	68,700 *
55	79.5	274.1	61,800 *	61,800 *
60	78.4	273.1	56,000 *	56,000 *
65	77.3	272.0	51,100 *	51,100 *
70	76.3	270.8	47,000 *	47,000 *
75	75.2	269.5	43,400 *	43,400 *
80	74.1	268.0	40,200 *	40,200 *
85	72.9	266.5	37,400 *	37,400 *
90	71.8	264.9	34,900 *	34,900 *
95	70.7	263.1	31,600	32,600 *
100	69.6	261.3	28,700	30,500 *
105	68.4	259.3	26,100	28,600 *
110	67.3	257.2	23,700	26,900 *
115	66.1	255.0	21,600	25,200 *
120	65.0	252.7	19,700	23,700 *
125	63.8	250.2	17,900	22,200 *
130	62.6	247.6	16,300	20,800 *
135	61.4	244.9	14,800	19,100 *
140	60.1	242.1	13,500	17,600 *
145	58.9	239.0	12,200	16,200 *
150	57.7	235.9	11,000	14,800 *
155	56.4	232.6	9,900	13,600 *
160	55.1	229.1	8,900	12,400 *
165	53.8	225.5	8,000	11,300 *
170	52.4	221.6	7,100	10,300 *
175	51.1	217.6	6,200	9,300 *
180	49.7	213.4	5,400	8,400 *
185	48.3	209.0	4,700	7,500 *
190	46.8	204.3	4,000	6,700 *
195	45.3	199.4	3,300	5,900 *
200	43.8	194.3	2,700	4,900 *
205	42.2	188.8	2,100	4,000 *
210	40.6	183.0		3,100 *
215	38.9	176.9		2,300 *



Liftcrane Jib Capacities

**Jib No. 134 With 12 Ft. 6 in. Strut On
Boom No. 78T With Heavy Lift Top
95,400 Lb. Crane Counterweight
25,000 Lb. Front Bumper Counterweight
360 Degree Rating On Fully Extended Outriggers**

Meets
ANSI B30.5
Requirements

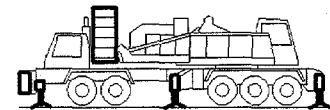

LIFTING CAPACITIES: Chart supplements boom capacity chart No. 8063-A. Lifting capacities for various boom lengths, jib lengths and jib operating radii are for freely suspended loads and do not exceed 85% of a static tipping load. Capacities based on structural competence are denoted by an asterisk (*).

Weight of all load blocks, hooks, weight ball, slings, hoist lines, etc., beneath boom and jib point sheaves, is considered part of the jib load. Boom and jib are not to be lowered beyond radii where combined weights are greater than rated capacity. Where no capacity is shown, operation is not intended or approved.

OPERATING CONDITIONS: Machine to operate in a level position on a firm uniformly supporting surface with outriggers fully extended (22 Ft. 8 in.) and set. Refer to operators manual for outrigger positioning. Radii less than 32 Ft. not recommended when lifting over front of truck. Minimum boom angle over truck cab is 24 degrees.

Note: Set four main jacks first, then lower center front jack until it just contacts ground to prevent preloading of center front jack. Center front jack must be used when operating on outriggers.

Refer to boom rigging No. 192043, jib assembly No. 179331, Wire Rope Specification chart No. 7973-A and Operating

Range Diagram chart No. 7974-A. Crane operator judgment must be used to allow for dynamic load effects of swinging, hoisting or lowering, wind conditions, as well as adverse operating conditions and physical machine depreciation. Refer to operators manual for operating guidelines.

OPERATING RADIUS: Operating radius is horizontal distance from axis of rotation to center of vertical hoist line or load block. Boom angle is angle between horizontal and centerline of boom butt and inserts, and is an indication of operating radius. In all cases, operating radius shall govern capacity.

JIB POINT ELEVATION: Jib point elevation is vertical distance from ground level to centerline of jib point shaft.

MACHINE EQUIPMENT: Machine equipped with Manitowoc 10 x 6 carrier, 277 in. wheel base, 117 in. front axle track, 100 in. rear axle track, 14.00 x 24 tires, 96 in. front outriggers, 70 in. rear outriggers, two 12 in. boom hoist cylinders, 26 Ft. mast, two boom support straps, 95,400 Lb. crane counterweight and 25,000 Lb. front bumper counterweight.

Maximum capacity on 26 mm or 1 in. wire rope is 29,500 Lbs. per line (20,000 Lbs. when auxiliary drum is used).

Deduct
Deduct 1,050 Lbs. from Jib Capacities when Boom Butt is Equipped with Auxiliary Drum.



777T

Liftcrane Jib Capacities

Meets
ANSI B30.5
Requirements

Jib No. 134 With 12 Ft. 6 in. Strut On
Boom No. 78T With Heavy Lift Top
95,400 Lb. Crane Counterweight
25,000 Lb. Front Bumper Counterweight
360 Degree Rating On Fully Extended Outriggers

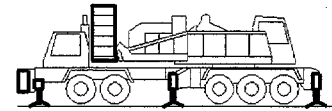

Maximum Boom and Jib Lengths Lifted Unassisted On Outriggers						
Over Rear of Outriggers		Over Side of Fully Extended Outriggers		Over Side of Partially Extended Outriggers		Over Side of Fully Retracted Outriggers
Boom Length	Jib No. 134	Boom Length	Jib No. 134	Boom Length	Jib No. 134	Boom Length
95,400 Lb. Crane Counterweight + 25,000 Lb. Front Bumper Cwt.						
(a) 270 Ft.	---	220 Ft.	---			
(b) 260 Ft.	---	210 Ft.	---			
250 Ft.	---	200 Ft.	30 Ft.	Not Allowed		Not Allowed
240 Ft.	30 Ft.	190 Ft.	60 Ft.			
230 Ft.	50 Ft.	180 Ft.	80 Ft.			
220 Ft.	80 Ft.					
95,400 Lb. Crane Counterweight						
(c) 240 Ft.	---	220 Ft.	---			
230 Ft.	---	210 Ft.	---			
210 Ft.	40 Ft.	200 Ft.	30 Ft.	Not Allowed		Not Allowed
200 Ft.	70 Ft.	190 Ft.	60 Ft.			
190 Ft.	80 Ft.	180 Ft.	80 Ft.			
78,400 Lb. Crane Counterweight						
220 Ft.	---	200 Ft.	---	180 Ft.	---	
210 Ft.	---	190 Ft.	---	170 Ft.	---	
200 Ft.	30 Ft.	180 Ft.	50 Ft.	160 Ft.	40 Ft.	Not Allowed
190 Ft.	60 Ft.	170 Ft.	70 Ft.	150 Ft.	70 Ft.	
180 Ft.	80 Ft.	160 Ft.	80 Ft.	140 Ft.	80 Ft.	
61,400 Lb. Crane Counterweight						
200 Ft.	---	180 Ft.	---	160 Ft.	---	
190 Ft.	---	170 Ft.	30 Ft.	150 Ft.	---	
180 Ft.	40 Ft.	160 Ft.	50 Ft.	140 Ft.	50 Ft.	Not Allowed
170 Ft.	70 Ft.	150 Ft.	70 Ft.	130 Ft.	80 Ft.	
160 Ft.	80 Ft.	140 Ft.	80 Ft.			
44,400 Lb. Crane Counterweight						
180 Ft.	---	160 Ft.	---	140 Ft.	---	
170 Ft.	---	150 Ft.	30 Ft.	130 Ft.	30 Ft.	
160 Ft.	40 Ft.	140 Ft.	60 Ft.	120 Ft.	60 Ft.	Not Allowed
150 Ft.	70 Ft.	130 Ft.	80 Ft.	110 Ft.	80 Ft.	
140 Ft.	80 Ft.					
Load block, hook and weight ball on ground at start. (a) Upper boom point and auxiliary drum cannot be used on 270 Ft. boom. (b) Upper boom point cannot be used on 260 Ft. boom over rear. (c) Upper boom point cannot be used on 240 Ft. boom over rear.						

Maximum Boom and Jib Lengths Lifted Unassisted On Rubber		
Over Rear		Over Side
Boom Length	Jib No. 134	Boom Length
95,400 Lb. Crane Counterweight + 25,000 Lb. Front Bumper Cwt.		
Not Allowed		
95,400 Lb. Crane Counterweight		
150 Ft.	---	
140 Ft.	---	
130 Ft.	40 Ft.	Not Allowed
120 Ft.	70 Ft.	
110 Ft.	80 Ft.	
78,400 Lb. Crane Counterweight		
130 Ft.	---	
120 Ft.	30 Ft.	
110 Ft.	50 Ft.	Not Allowed
100 Ft.	80 Ft.	
61,400 Lb. Crane Counterweight		
120 Ft.	---	
110 Ft.	---	
100 Ft.	40 Ft.	Not Allowed
44,400 Lb. Crane Counterweight		
100 Ft.	---	
Not Allowed		
Load block, hook and weight ball on ground at start.		

Liftcrane Jib Capacities

Jib No. 134 With 12 Ft. 6 in. Strut On
 Boom No. 78T With Heavy Lift Top
 95,400 Lb. Crane Counterweight
 25,000 Lb. Front Bumper Counterweight
 360 Degree Rating On Fully Extended Outriggers

Meets
ANSI B30.5
Requirements

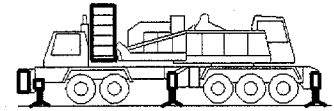

Maximum Boom and Jib Lengths Lifted Unassisted On Outriggers						
Over Rear of Outriggers		Over Side of Fully Extended Outriggers		Over Side of Partially Extended Outriggers		Over Side of Fully Retracted Outriggers
Boom Length	Jib No. 134	Boom Length	Jib No. 134	Boom Length	Jib No. 134	Boom Length
27,400 Lb. Crane Counterweight						
160 Ft.	---	140 Ft.	---	120 Ft.	---	70 Ft.
150 Ft.	---	130 Ft.	30 Ft.	110 Ft.	---	
140 Ft.	50 Ft.	120 Ft.	60 Ft.	100 Ft.	50 Ft.	
130 Ft.	80 Ft.	110 Ft.	80 Ft.			
10,400 Lb. Crane Counterweight						
140 Ft.	---	120 Ft.	---	100 Ft.	---	42.5 Ft.
130 Ft.	---	110 Ft.	---			
120 Ft.	50 Ft.	100 Ft.	50 Ft.			
110 Ft.	70 Ft.					
100 Ft.	80 Ft.					
0 Lb. Crane Counterweight						
130 Ft.	---	100 Ft.	---	80 Ft.	---	
120 Ft.	---					Not Allowed
110 Ft.	40 Ft.					
100 Ft.	60 Ft.					
Load block, hook and weight ball on ground at start.						

Maximum Boom and Jib Lengths Lifted Unassisted On Rubber		
Over Rear		Over Side
Boom Length	Jib No. 134	Boom Length
27,400 Lb. Crane Counterweight		
80 Ft.	---	Not Allowed
10,400 Lb. Crane Counterweight		
60 Ft.	---	42.5 Ft.
0 Lb. Crane Counterweight		
42.5 Ft.	---	Not Allowed
Load block, hook and weight ball on ground at start.		



777T

Liftcrane Jib Capacities

Meets
ANSI B30.5
Requirements

Jib No. 134 With 12 Ft. 6 in. Strut On
Boom No. 78T With Heavy Lift Top
95,400 Lb. Crane Counterweight
25,000 Lb. Front Bumper Counterweight
360 Degree Rating On Fully Extended Outriggers

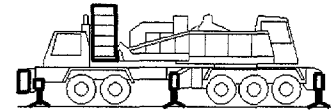

30 Ft. JIB

Jib Oper. Rad. Feet	5 Degree Offset			15 Degree Offset			25 Degree Offset			Jib Oper. Rad. Feet
	Boom Ang. Deg.	Jib Point Elev. Feet	Jib Capacity Pounds	Boom Ang. Deg.	Jib Point Elev. Feet	Jib Capacity Pounds	Boom Ang. Deg.	Jib Point Elev. Feet	Jib Capacity Pounds	
100 Ft. BOOM										
30	79.6	138.6	59,000*							30
35	77.4	137.5	59,000*	79.6	136.7	59,000*				35
40	75.1	136.2	59,000*	77.4	135.4	58,600*	79.7	133.6	46,600*	40
45	72.8	134.6	59,000*	75.1	133.8	57,500*	77.4	132.0	44,300*	45
50	70.5	132.9	59,000*	72.8	132.1	56,600*	75.0	130.2	42,200*	50
55	68.2	130.9	58,600*	70.4	130.1	55,700*	72.7	128.2	40,400*	55
60	65.8	128.7	57,500*	68.0	127.8	54,800*	70.2	125.9	38,700*	60
65	63.4	126.2	56,400*	65.6	125.3	54,100*	67.8	123.3	37,200*	65
70	60.9	123.4	55,400*	63.1	122.5	53,400*	65.2	120.5	35,900*	70
75	58.4	120.3	53,600	60.6	119.4	52,100*	62.6	117.4	34,700*	75
80	55.8	117.0	48,800	57.9	116.0	49,500	59.9	113.9	33,600*	80
85	53.1	113.2	44,500	55.2	112.3	45,200	57.1	110.1	32,500*	85
90	50.3	109.1	40,900	52.4	108.1	41,400	54.2	105.8	31,600*	90
100	44.3	99.5	34,700	46.3	98.4	35,200	48.0	95.8	30,100*	100
110	37.5	87.5	29,800	39.4	86.2	30,100	40.9	83.2	28,900*	110
120	29.4	71.7	25,700	31.1	70.0	26,000	32.2	66.2	26,100	120
130	18.1	47.6	22,300	19.3	45.0	22,400				130



Liftcrane Jib Capacities

Meets
 ANSI B30.5
 Requirements

Jib No. 134 With 12 Ft. 6 in. Strut On
 Boom No. 78T With Heavy Lift Top
 95,400 Lb. Crane Counterweight
 25,000 Lb. Front Bumper Counterweight
 360 Degree Rating On Fully Extended Outriggers

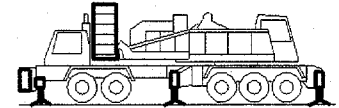

30 Ft. JIB

Jib Oper. Rad. Feet	5 Degree Offset			15 Degree Offset			25 Degree Offset			Jib Oper. Rad. Feet
	Boom Ang. Deg.	Jib Point Elev. Feet	Jib Capacity Pounds	Boom Ang. Deg.	Jib Point Elev. Feet	Jib Capacity Pounds	Boom Ang. Deg.	Jib Point Elev. Feet	Jib Capacity Pounds	
110 Ft. BOOM										
30	80.3	148.8	59,000*							30
35	78.3	147.8	59,000*	80.4	147.0	59,000*				35
40	76.2	146.6	59,000*	78.3	145.8	58,800*	80.5	143.9	47,300*	40
45	74.1	145.1	59,000*	76.2	144.3	57,900*	78.3	142.5	45,100*	45
50	72.0	143.5	59,000*	74.1	142.7	56,900*	76.2	140.8	43,100*	50
55	69.8	141.7	59,000*	71.9	140.8	56,100*	74.0	139.0	41,300*	55
60	67.6	139.6	58,300*	69.7	138.8	55,300*	71.8	136.9	39,700*	60
65	65.4	137.3	57,200*	67.5	136.5	54,500*	69.5	134.5	38,200*	65
70	63.2	134.8	56,200*	65.2	133.9	53,800*	67.2	132.0	36,900*	70
75	60.9	132.1	53,400	62.9	131.2	52,200*	64.8	129.1	35,700*	75
80	58.5	129.0	48,500	60.5	128.1	48,700*	62.4	126.0	34,500*	80
85	56.1	125.7	44,300	58.1	124.7	44,900	59.9	122.6	33,500*	85
90	53.6	122.0	40,600	55.6	121.0	41,200	57.4	118.8	32,600*	90
100	48.3	113.6	34,500	50.2	112.5	34,900	51.9	110.1	31,000*	100
110	42.6	103.4	29,500	44.4	102.2	29,900	45.9	99.5	29,600*	110
120	36.1	90.7	25,500	37.8	89.3	25,800	39.1	86.2	26,000	120
130	28.3	74.1	22,100	29.8	72.4	22,300	30.7	68.4	22,400	130
140	17.4	49.1	19,200	18.5	46.3	19,200				140



777T

Liftcrane Jib Capacities

Jib No. 134 With 12 Ft. 6 in. Strut On
Boom No. 78T With Heavy Lift Top
95,400 Lb. Crane Counterweight
25,000 Lb. Front Bumper Counterweight
360 Degree Rating On Fully Extended Outriggers

Meets
ANSI B30.5
Requirements

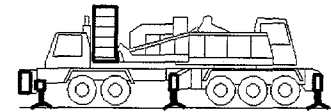

30 Ft. JIB

Jib Oper. Rad. Feet	5 Degree Offset			15 Degree Offset			25 Degree Offset			Jib Oper. Rad. Feet
	Boom Ang. Deg.	Jib Point Elev. Feet	Jib Capacity Pounds	Boom Ang. Deg.	Jib Point Elev. Feet	Jib Capacity Pounds	Boom Ang. Deg.	Jib Point Elev. Feet	Jib Capacity Pounds	
120 Ft. BOOM										
30	81.0	159.0	59,000 *							30
35	79.0	158.0	59,000 *	81.0	157.2	59,000*				35
40	77.1	156.9	59,000 *	79.1	156.1	59,000*				40
45	75.2	155.6	59,000 *	77.1	154.7	58,100*	79.1	152.9	45,800*	45
50	73.2	154.0	59,000 *	75.2	153.2	57,200*	77.1	151.3	43,900*	50
55	71.2	152.3	59,000 *	73.2	151.5	56,300*	75.1	149.6	42,200*	55
60	69.2	150.5	58,800 *	71.1	149.6	55,600*	73.1	147.7	40,600*	60
65	67.2	148.4	57,800 *	69.1	147.5	54,800*	71.0	145.5	39,100*	65
70	65.1	146.0	56,800 *	67.0	145.2	54,200*	68.9	143.2	37,800*	70
75	63.0	143.5	53,100 *	64.9	142.6	51,600*	66.7	140.6	36,600*	75
80	60.8	140.7	48,500	62.7	139.8	48,100*	64.5	137.7	35,500*	80
85	58.6	137.7	44,200	60.5	136.7	44,900	62.2	134.6	34,400*	85
90	56.4	134.4	40,600	58.2	133.4	41,200	59.9	131.2	33,500*	90
100	51.6	126.8	34,400	53.5	125.8	35,000	55.1	123.5	31,800*	100
110	46.6	117.9	29,500	48.4	116.8	30,000	49.9	114.2	30,300	110
120	41.1	107.1	25,500	42.8	105.9	25,800	44.1	103.0	26,100	120
130	34.8	93.8	22,100	36.4	92.4	22,400	37.5	89.1	22,600	130
140	27.3	76.5	19,300	28.7	74.7	19,400	29.5	70.5	19,500	140
150	16.8	50.5	16,700	17.7	47.5	16,800				150



Liftcrane Jib Capacities

Jib No. 134 With 12 Ft. 6 in. Strut On
 Boom No. 78T With Heavy Lift Top
 95,400 Lb. Crane Counterweight
 25,000 Lb. Front Bumper Counterweight
 360 Degree Rating On Fully Extended Outriggers

Meets
 ANSI B30.5
 Requirements

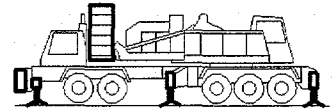

30 Ft. JIB

Jib Oper. Rad. Feet	5 Degree Offset			15 Degree Offset			25 Degree Offset			Jib Oper. Rad. Feet
	Boom Ang. Deg.	Jib Point Elev. Feet	Jib Capacity Pounds	Boom Ang. Deg.	Jib Point Elev. Feet	Jib Capacity Pounds	Boom Ang. Deg.	Jib Point Elev. Feet	Jib Capacity Pounds	
130 Ft. BOOM										
35	79.7	168.2	59,000*							35
40	77.9	167.2	59,000*	79.8	166.3	59,000*				40
45	76.1	165.9	59,000*	78.0	165.1	58,200*	79.8	163.2	46,500*	45
50	74.3	164.5	59,000*	76.1	163.7	57,300*	78.0	161.8	44,600*	50
55	72.4	162.9	59,000*	74.2	162.1	56,500*	76.1	160.2	42,900*	55
60	70.5	161.2	59,000*	72.4	160.3	55,800*	74.2	158.4	41,400*	60
65	68.6	159.2	58,200*	70.5	158.4	55,100*	72.3	156.4	39,900*	65
70	66.7	157.1	55,900*	68.5	156.2	54,400*	70.3	154.2	38,600*	70
75	64.8	154.7	51,800*	66.6	153.8	50,500*	68.3	151.8	37,400*	75
80	62.8	152.2	48,100	64.6	151.2	47,000*	66.3	149.2	36,300*	80
85	60.8	149.4	43,900	62.5	148.4	43,900*	64.2	146.3	35,300*	85
90	58.7	146.3	40,200	60.4	145.4	40,900	62.1	143.2	34,300*	90
100	54.4	139.5	34,000	56.1	138.5	34,600	57.7	136.2	32,600*	100
110	49.9	131.5	29,100	51.6	130.4	29,600	53.1	128.0	30,000	110
120	45.0	122.0	25,100	46.7	120.8	25,500	48.0	118.2	25,800	120
130	39.7	110.7	21,700	41.3	109.4	22,100	42.5	106.4	22,300	130
140	33.6	96.8	18,900	35.1	95.3	19,100	36.1	91.8	19,300	140
150	26.4	78.8	16,400	27.7	76.9	16,600	28.3	72.5	16,600	150
160	16.2	51.9	14,200	17.1	48.7	14,300				160



Liftcrane Jib Capacities

Jib No. 134 With 12 Ft. 6 in. Strut On
 Boom No. 78T With Heavy Lift Top
 95,400 Lb. Crane Counterweight
 25,000 Lb. Front Bumper Counterweight
 360 Degree Rating On Fully Extended Outriggers

Meets
 ANSI B30.5
 Requirements

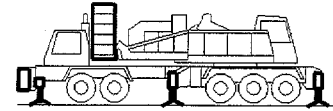

30 Ft. JIB

Jib Oper. Rad. Feet	5 Degree Offset			15 Degree Offset			25 Degree Offset			Jib Oper. Rad. Feet
	Boom Ang. Deg.	Jib Point Elev. Feet	Jib Capacity Pounds	Boom Ang. Deg.	Jib Point Elev. Feet	Jib Capacity Pounds	Boom Ang. Deg.	Jib Point Elev. Feet	Jib Capacity Pounds	
140 Ft. BOOM										
35	80.3	178.4	59,000*							35
40	78.6	177.4	59,000*	80.4	176.6	59,000*				40
45	76.9	176.2	59,000*	78.7	175.4	58,200*	80.5	173.5	47,100*	45
50	75.2	174.9	59,000*	76.9	174.1	57,400*	78.7	172.2	45,300*	50
55	73.5	173.4	59,000*	75.2	172.6	56,600*	76.9	170.7	43,600*	55
60	71.7	171.8	59,000*	73.4	170.9	55,900*	75.2	169.0	42,100*	60
65	69.9	170.0	58,500*	71.7	169.1	55,300*	73.4	167.1	40,700*	65
70	68.2	168.0	54,600*	69.9	167.1	53,400*	71.5	165.1	39,400*	70
75	66.3	165.8	50,600*	68.0	164.9	49,500*	69.7	162.9	38,200*	75
80	64.5	163.4	47,000*	66.2	162.5	46,000*	67.8	160.4	37,100*	80
85	62.6	160.8	43,500	64.3	159.9	42,800*	65.9	157.8	36,100*	85
90	60.7	158.0	39,800	62.4	157.1	39,900*	64.0	155.0	35,100*	90
100	56.8	151.8	33,700	58.4	150.8	34,300	59.9	148.5	33,400*	100
110	52.7	144.4	28,800	54.3	143.4	29,300	55.7	141.1	29,600*	110
120	48.3	135.9	24,700	49.9	134.8	25,200	51.2	132.3	25,600	120
130	43.6	126.0	21,400	45.1	124.8	21,700	46.4	122.0	22,000	130
140	38.4	114.1	18,500	39.9	112.8	18,800	41.0	109.7	19,000	140
150	32.6	99.7	16,100	34.0	98.1	16,300	34.9	94.5	16,400	150
160	25.6	81.0	13,900	26.8	79.1	14,100	27.3	74.4	14,100	160
170	15.7	53.2	12,000	16.5	49.9	12,000				170



Liftcrane Jib Capacities

Meets
ANSI B30.5
Requirements

Jib No. 134 With 12 Ft. 6 in. Strut On
Boom No. 78T With Heavy Lift Top
95,400 Lb. Crane Counterweight
25,000 Lb. Front Bumper Counterweight
360 Degree Rating On Fully Extended Outriggers

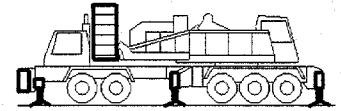

30 Ft. JIB

Jib Oper. Rad. Feet	5 Degree Offset			15 Degree Offset			25 Degree Offset			Jib Oper. Rad. Feet
	Boom Ang. Deg.	Jib Point Elev. Feet	Jib Capacity Pounds	Boom Ang. Deg.	Jib Point Elev. Feet	Jib Capacity Pounds	Boom Ang. Deg.	Jib Point Elev. Feet	Jib Capacity Pounds	
150 Ft. BOOM										
35	80.9	188.6	59,000 *							35
40	79.3	187.6	59,000 *	80.9	186.8	58,700*				40
45	77.7	186.5	59,000 *	79.3	185.7	58,000*	81.0	183.8	47,700*	45
50	76.0	185.3	59,000 *	77.7	184.4	57,200*	79.4	182.5	45,900*	50
55	74.4	183.9	59,000 *	76.0	183.0	56,500*	77.7	181.1	44,300*	55
60	72.8	182.3	59,000 *	74.4	181.5	55,800*	76.0	179.5	42,800*	60
65	71.1	180.6	58,500 *	72.7	179.8	55,100*	74.3	177.8	41,400*	65
70	69.4	178.8	56,900 *	71.0	177.9	54,400*	72.6	175.9	40,200*	70
75	67.7	176.7	52,100	69.3	175.8	51,300*	70.9	173.8	39,000*	75
80	66.0	174.5	47,200	67.6	173.6	47,700*	69.1	171.5	37,900*	80
85	64.3	172.1	42,900	65.8	171.2	43,800	67.4	169.1	36,800*	85
90	62.5	169.5	39,200	64.1	168.6	40,000	65.6	166.4	35,900*	90
100	58.8	163.7	33,000	60.4	162.7	33,700	61.9	160.5	34,200*	100
110	55.1	157.0	28,100	56.6	156.0	28,700	58.0	153.7	29,200	110
120	51.1	149.2	24,100	52.6	148.2	24,600	53.9	145.7	25,000	120
130	46.9	140.3	20,700	48.3	139.1	21,100	49.6	136.5	21,500	130
140	42.3	129.8	17,900	43.7	128.6	18,200	44.9	125.7	18,500	140
150	37.3	117.5	15,400	38.7	116.1	15,700	39.7	112.9	15,900	150
160	31.6	102.5	13,300	32.9	100.8	13,500	33.7	97.1	13,600	160
170	24.8	83.2	11,400	25.9	81.1	11,500				170
180	15.2	54.5	9,600	15.9	51.0	9,700				180



777T

Liftcrane Jib Capacities

Meets
ANSI B30.5
Requirements

Jib No. 134 With 12 Ft. 6 in. Strut On
Boom No. 78T With Heavy Lift Top
95,400 Lb. Crane Counterweight
25,000 Lb. Front Bumper Counterweight
360 Degree Rating On Fully Extended Outriggers

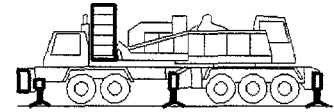

30 Ft. JIB

Jib Oper. Rad. Feet	5 Degree Offset			15 Degree Offset			25 Degree Offset			Jib Oper. Rad. Feet
	Boom Ang. Deg.	Jib Point Elev. Feet	Jib Capacity Pounds	Boom Ang. Deg.	Jib Point Elev. Feet	Jib Capacity Pounds	Boom Ang. Deg.	Jib Point Elev. Feet	Jib Capacity Pounds	
160 Ft. BOOM										
40	79.8	197.8	59,000*							40
45	78.3	196.8	59,000*	79.9	195.9	57,800*				45
50	76.8	195.6	59,000*	78.3	194.8	57,100*	79.9	192.8	46,500*	50
55	75.2	194.3	59,000*	76.8	193.4	56,400*	78.4	191.5	44,900*	55
60	73.7	192.8	59,000*	75.2	192.0	55,700*	76.8	190.0	43,400*	60
65	72.1	191.2	58,500*	73.7	190.3	55,000*	75.2	188.4	42,100*	65
70	70.5	189.5	57,000*	72.1	188.6	52,600*	73.6	186.6	40,800*	70
75	68.9	187.5	51,700	70.5	186.6	48,500*	72.0	184.6	39,700*	75
80	67.3	185.4	46,800	68.8	184.5	44,600*	70.3	182.5	38,600*	80
85	65.7	183.2	42,500	67.2	182.3	41,400*	68.7	180.2	37,600*	85
90	64.0	180.8	38,800	65.5	179.8	38,400*	67.0	177.7	36,600*	90
100	60.6	175.3	32,600	62.1	174.4	33,400	63.5	172.2	32,100*	100
110	57.1	169.1	27,700	58.6	168.1	28,300	59.9	165.9	28,300*	110
120	53.5	162.0	23,700	54.9	161.0	24,200	56.2	158.6	24,700	120
130	49.6	153.8	20,300	51.0	152.7	20,800	52.3	150.2	21,200	130
140	45.5	144.4	17,500	46.9	143.3	17,900	48.1	140.6	18,200	140
150	41.1	133.6	15,000	42.5	132.3	15,300	43.5	129.3	15,600	150
160	36.3	120.7	12,900	37.6	119.3	13,200	38.5	116.0	13,300	160
170	30.8	105.2	11,000	32.0	103.5	11,200	32.7	99.6	11,300	170
180	24.1	85.3	9,300	25.2	83.1	9,500				180
190	14.8	55.7	7,800							190



Liftcrane Jib Capacities

Jib No. 134 With 12 Ft. 6 in. Strut On
Boom No. 78T With Heavy Lift Top
95,400 Lb. Crane Counterweight
25,000 Lb. Front Bumper Counterweight
360 Degree Rating On Fully Extended Outriggers

Meets
ANSI B30.5
Requirements

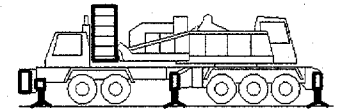

30 Ft. JIB

Jib Oper. Rad. Feet	5 Degree Offset			15 Degree Offset			25 Degree Offset			Jib Oper. Rad. Feet
	Boom Ang. Deg.	Jib Point Elev. Feet	Jib Capacity Pounds	Boom Ang. Deg.	Jib Point Elev. Feet	Jib Capacity Pounds	Boom Ang. Deg.	Jib Point Elev. Feet	Jib Capacity Pounds	
170 Ft. BOOM										
40	80.3	208.0	59,000*							40
45	78.9	207.0	59,000*	80.4	206.2	57,600*				45
50	77.4	205.9	59,000*	78.9	205.0	56,900*	80.4	203.1	47,000*	50
55	76.0	204.7	59,000*	77.5	203.8	56,200*	79.0	201.8	45,500*	55
60	74.5	203.3	59,000*	76.0	202.4	55,600*	77.5	200.4	44,000*	60
65	73.0	201.7	58,500*	74.5	200.9	53,900*	76.0	198.9	42,700*	65
70	71.5	200.1	54,000*	73.0	199.2	50,100*	74.5	197.2	41,500*	70
75	70.0	198.3	49,300*	71.5	197.4	45,700*	72.9	195.3	40,300*	75
80	68.5	196.3	45,200*	70.0	195.4	42,200*	71.4	193.3	39,200*	80
85	67.0	194.2	41,600*	68.4	193.3	39,000*	69.8	191.2	37,100*	85
90	65.4	191.9	38,500*	66.8	191.0	36,200*	68.2	188.9	34,400*	90
100	62.2	186.8	32,500	63.7	185.9	31,400*	65.0	183.7	30,100*	100
110	59.0	181.0	27,500	60.4	180.0	27,500*	61.7	177.8	26,500*	110
120	55.6	174.4	23,500	56.9	173.4	24,100	58.2	171.0	23,400*	120
130	52.0	166.9	20,200	53.4	165.8	20,600	54.6	163.4	20,800*	130
140	48.3	158.3	17,300	49.6	157.2	17,700	50.8	154.6	18,100	140
150	44.3	148.5	14,900	45.6	147.3	15,200	46.7	144.5	15,500	150
160	40.0	137.2	12,800	41.3	135.9	13,000	42.3	132.8	13,300	160
170	35.3	123.9	10,900	36.5	122.4	11,100	37.4	119.0	11,300	170
180	30.0	107.8	9,200	31.1	106.1	9,400	31.7	102.1	9,500	180
190	23.5	87.3	7,700	24.5	85.1	7,800				190
200	14.4	56.9	6,300							200



777T

Liftcrane Jib Capacities

Jib No. 134 With 12 Ft. 6 in. Strut On
Boom No. 78T With Heavy Lift Top
95,400 Lb. Crane Counterweight
25,000 Lb. Front Bumper Counterweight
360 Degree Rating On Fully Extended Outriggers

Meets
ANSI B30.5
Requirements

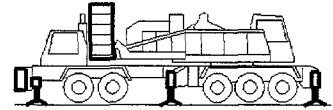

30 Ft. JIB

Jib Oper. Rad. Feet	5 Degree Offset			15 Degree Offset			25 Degree Offset			Jib Oper. Rad. Feet
	Boom Ang. Deg.	Jib Point Elev. Feet	Jib Capacity Pounds	Boom Ang. Deg.	Jib Point Elev. Feet	Jib Capacity Pounds	Boom Ang. Deg.	Jib Point Elev. Feet	Jib Capacity Pounds	
180 Ft. BOOM										
40	80.8	218.2	59,000*							40
45	79.4	217.2	59,000*	80.9	216.4	57,300*				45
50	78.0	216.2	59,000*	79.5	215.3	56,700*	80.9	213.3	47,500*	50
55	76.7	215.0	59,000*	78.1	214.1	55,800*	79.5	212.1	46,000*	55
60	75.3	213.7	59,000*	76.7	212.8	55,400*	78.1	210.8	44,600*	60
65	73.9	212.2	58,400*	75.3	211.3	54,900*	76.7	209.3	43,300*	65
70	72.4	210.6	54,700*	73.8	209.7	50,800*	75.2	207.7	42,100*	70
75	71.0	208.9	50,500*	72.4	208.0	46,900*	73.8	206.0	40,900*	75
80	69.6	207.1	46,200	71.0	206.2	43,100*	72.3	204.1	39,900*	80
85	68.1	205.0	41,900	69.5	204.1	39,900*	70.8	202.1	37,800*	85
90	66.7	202.9	38,200	68.0	202.0	37,000*	69.4	199.9	35,000*	90
100	63.7	198.1	32,000	65.0	197.2	32,100*	66.3	195.0	30,600*	100
110	60.6	192.7	27,100	61.9	191.7	27,800	63.2	189.5	26,900*	110
120	57.4	186.5	23,100	58.7	185.5	23,600	60.0	183.2	23,800*	120
130	54.1	179.5	19,700	55.4	178.5	20,200	56.6	176.1	20,700	130
140	50.7	171.6	16,900	52.0	170.5	17,300	53.1	168.0	17,700	140
150	47.1	162.6	14,400	48.3	161.5	14,800	49.4	158.8	15,100	150
160	43.2	152.4	12,300	44.4	151.2	12,600	45.4	148.3	12,900	160
170	39.0	140.7	10,400	40.2	139.3	10,700	41.1	136.2	10,900	170
180	34.4	126.9	8,800	35.6	125.4	9,000	36.3	121.9	9,100	180
190	29.2	110.4	7,300	30.3	108.6	7,500	30.8	104.5	7,600	190
200	22.9	89.3	5,900	23.8	87.0	6,100				200
210	14.1	58.1	4,700							210

Liftcrane Jib Capacities

Meets
ANSI B30.5
Requirements

Jib No. 134 With 12 Ft. 6 in. Strut On
Boom No. 78T With Heavy Lift Top
95,400 Lb. Crane Counterweight
25,000 Lb. Front Bumper Counterweight
360 Degree Rating On Fully Extended Outriggers

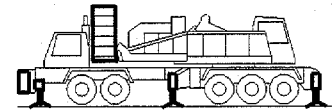

30 Ft. JIB

Jib Oper. Rad. Feet	5 Degree Offset			15 Degree Offset			25 Degree Offset			Jib Oper. Rad. Feet
	Boom Ang. Deg.	Jib Point Elev. Feet	Jib Capacity Pounds	Boom Ang. Deg.	Jib Point Elev. Feet	Jib Capacity Pounds	Boom Ang. Deg.	Jib Point Elev. Feet	Jib Capacity Pounds	
190 Ft. BOOM										
45	79.9	227.4	59,000*							45
50	78.6	226.4	59,000*	80.0	225.5	56,400*				50
55	77.3	225.3	59,000*	78.6	224.4	55,800*	80.0	222.4	46,500*	55
60	75.9	224.0	59,000*	77.3	223.1	55,200*	78.7	221.2	45,100*	60
65	74.6	222.6	56,700*	75.9	221.8	54,700*	77.3	219.8	43,800*	65
70	73.3	221.1	52,400*	74.6	220.2	51,400*	75.9	218.2	42,600*	70
75	71.9	219.5	48,300*	73.2	218.6	47,400*	74.6	216.6	41,500*	75
80	70.5	217.7	44,600*	71.9	216.8	43,700*	73.2	214.8	40,500*	80
85	69.2	215.8	41,300*	70.5	214.9	40,300*	71.8	212.9	38,300*	85
90	67.8	213.8	37,800	69.1	212.9	37,400*	70.4	210.8	35,700*	90
100	64.9	209.3	31,600	66.2	208.3	32,400	67.5	206.2	31,200*	100
110	62.0	204.1	26,700	63.3	203.2	27,400	64.5	201.0	27,200*	110
120	59.1	198.3	22,600	60.3	197.3	23,300	61.5	195.1	23,700*	120
130	56.0	191.8	19,300	57.2	190.8	19,800	58.4	188.4	20,300	130
140	52.8	184.5	16,400	54.0	183.4	16,900	55.1	180.9	17,300	140
150	49.4	176.2	14,000	50.6	175.1	14,400	51.7	172.5	14,800	150
160	45.9	166.9	11,900	47.1	165.7	12,200	48.1	162.9	12,500	160
170	42.2	156.3	10,000	43.3	155.0	10,300	44.2	152.1	10,600	170
180	38.1	144.1	8,400	39.2	142.7	8,600	40.0	139.5	8,800	180
190	33.6	129.9	6,900	34.7	128.4	7,100	35.4	124.8	7,200	190
200	28.5	112.9	5,500	29.5	111.1	5,700	30.0	106.8	5,800	200
210	22.4	91.2	4,300	23.2	88.9	4,400				210
220	13.7	59.2	3,200							220



777T

Liftcrane Jib Capacities

Jib No. 134 With 12 Ft. 6 in. Strut On
Boom No. 78T With Heavy Lift Top
95,400 Lb. Crane Counterweight
25,000 Lb. Front Bumper Counterweight
360 Degree Rating On Fully Extended Outriggers

Meets
ANSI B30.5
Requirements

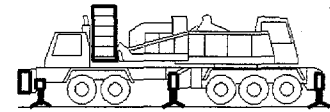

30 Ft. JIB

Jib Oper. Rad. Feet	5 Degree Offset			15 Degree Offset			25 Degree Offset			Jib Oper. Rad. Feet
	Boom Ang. Deg.	Jib Point Elev. Feet	Jib Capacity Pounds	Boom Ang. Deg.	Jib Point Elev. Feet	Jib Capacity Pounds	Boom Ang. Deg.	Jib Point Elev. Feet	Jib Capacity Pounds	
200 Ft. BOOM										
45	80.4	237.6	59,000*							45
50	79.1	236.6	59,000*	80.4	235.7	56,100*				50
55	77.8	235.5	59,000*	79.1	234.7	55,500*	80.4	232.7	46,900*	55
60	76.6	234.3	58,700*	77.9	233.5	55,000*	79.2	231.5	45,600*	60
65	75.3	233.0	54,700*	76.6	232.1	54,000*	77.9	230.1	44,300*	65
70	74.0	231.6	50,400*	75.3	230.7	49,500*	76.6	228.7	43,200*	70
75	72.7	230.0	46,300*	74.0	229.1	45,500*	75.3	227.1	42,100*	75
80	71.4	228.4	42,400*	72.7	227.5	42,000*	73.9	225.4	40,300*	80
85	70.1	226.5	39,200*	71.4	225.6	38,600*	72.6	223.6	37,200*	85
90	68.8	224.6	36,300*	70.0	223.7	35,800*	71.3	221.6	34,500*	90
100	66.1	220.3	31,200	67.3	219.4	30,800*	68.5	217.3	29,700*	100
110	63.3	215.5	26,200	64.6	214.5	26,600*	65.8	212.3	25,800*	110
120	60.5	210.0	22,200	61.8	209.0	22,800	62.9	206.8	22,300*	120
130	57.6	203.8	18,800	58.8	202.8	19,400	60.0	200.5	19,500*	130
140	54.6	197.0	15,900	55.8	195.9	16,500	56.9	193.5	16,800*	140
150	51.5	189.3	13,500	52.7	188.2	13,900	53.7	185.7	14,300	150
160	48.3	180.7	11,400	49.4	179.5	11,800	50.4	176.9	12,100	160
170	44.8	171.0	9,500	46.0	169.8	9,900	46.9	167.0	10,100	170
180	41.2	160.0	7,900	42.3	158.7	8,200	43.1	155.7	8,400	180
190	37.2	147.5	6,400	38.3	146.0	6,600	39.0	142.7	6,800	190
200	32.9	132.9	5,100	33.9	131.3	5,300	34.5	127.5	5,400	200
210	27.9	115.3	3,900	28.8	113.5	4,000	29.3	109.1	4,100	210
220	21.9	93.1	2,800	22.6	90.7	2,900				220

Liftcrane Jib Capacities

Meets
ANSI B30.5
Requirements

Jib No. 134 With 12 Ft. 6 in. Strut On
Boom No. 78T With Heavy Lift Top
95,400 Lb. Crane Counterweight
25,000 Lb. Front Bumper Counterweight
360 Degree Rating On Fully Extended Outriggers

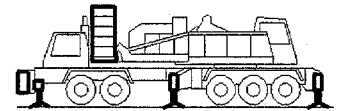

30 Ft. JIB

Jib Oper. Rad. Feet	5 Degree Offset			15 Degree Offset			25 Degree Offset			Jib Oper. Rad. Feet
	Boom Ang. Deg.	Jib Point Elev. Feet	Jib Capacity Pounds	Boom Ang. Deg.	Jib Point Elev. Feet	Jib Capacity Pounds	Boom Ang. Deg.	Jib Point Elev. Feet	Jib Capacity Pounds	
210 Ft. BOOM										
45	80.8	247.7	59,000*							45
50	79.6	246.8	59,000*	80.8	245.9	55,400*				50
55	78.3	245.8	58,700*	79.6	244.9	54,800*	80.9	242.9	46,100*	55
60	77.1	244.6	57,400*	78.4	243.8	52,300*	79.6	241.8	44,300*	60
65	75.9	243.4	54,200*	77.1	242.5	49,400*	78.4	240.5	42,500*	65
70	74.7	242.0	51,100*	75.9	241.1	46,900*	77.1	239.1	40,800*	70
75	73.5	240.5	47,300*	74.7	239.6	43,100*	75.9	237.6	39,300*	75
80	72.2	238.9	43,300*	73.4	238.0	39,500*	74.6	236.0	36,700*	80
85	71.0	237.2	39,700*	72.2	236.3	36,500*	73.4	234.2	34,100*	85
90	69.7	235.3	36,500*	70.9	234.4	33,800*	72.1	232.3	31,600*	90
100	67.1	231.3	30,800	68.3	230.3	29,100*	69.5	228.2	27,500*	100
110	64.5	226.6	25,900	65.7	225.7	25,300*	66.9	223.5	24,000*	110
120	61.9	221.5	21,800	63.0	220.5	22,200*	64.2	218.3	21,000*	120
130	59.1	215.7	18,500	60.3	214.7	19,100	61.4	212.4	18,600*	130
140	56.3	209.2	15,600	57.5	208.2	16,100	58.5	205.8	16,400*	140
150	53.4	202.0	13,200	54.5	200.9	13,600	55.5	198.5	14,100	150
160	50.4	194.0	11,100	51.5	192.8	11,500	52.5	190.3	11,800	160
170	47.2	185.0	9,200	48.3	183.8	9,600	49.2	181.1	9,900	170
180	43.8	175.0	7,600	44.9	173.7	7,900	45.8	170.9	8,100	180
190	40.3	163.7	6,100	41.3	162.3	6,400	42.1	159.2	6,600	190
200	36.4	150.7	4,800	37.4	149.3	5,000	38.1	145.9	5,200	200
210	32.1	135.7	3,600	33.1	134.1	3,800	33.7	130.3	3,900	210
220	27.3	117.7	2,500	28.1	115.8	2,600				220



Liftcrane Jib Capacities

Meets
ANSI B30.5
Requirements

Jib No. 134 With 12 Ft. 6 in. Strut On
Boom No. 78T With Heavy Lift Top
95,400 Lb. Crane Counterweight
25,000 Lb. Front Bumper Counterweight
360 Degree Rating On Fully Extended Outriggers

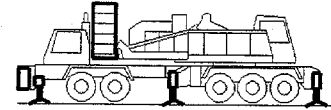

30 Ft. JIB

Jib Oper. Rad. Feet	5 Degree Offset			15 Degree Offset			25 Degree Offset			Jib Oper. Rad. Feet
	Boom Ang. Deg.	Jib Point Elev. Feet	Jib Capacity Pounds	Boom Ang. Deg.	Jib Point Elev. Feet	Jib Capacity Pounds	Boom Ang. Deg.	Jib Point Elev. Feet	Jib Capacity Pounds	
220 Ft. BOOM										
50	80.0	257.0	59,000*							50
55	78.8	256.0	58,200*	80.0	255.1	54,400*				55
60	77.6	254.9	57,600*	78.8	254.0	53,900*	80.0	252.0	45,800*	60
65	76.5	253.7	56,400*	77.7	252.8	52,500*	78.9	250.8	44,200*	65
70	75.3	252.4	51,500*	76.5	251.5	48,000*	77.7	249.5	42,700*	70
75	74.1	251.0	47,400*	75.3	250.1	44,000*	76.5	248.0	40,300*	75
80	72.9	249.4	44,000*	74.1	248.5	40,500*	75.3	246.5	37,300*	80
85	71.7	247.8	40,500	72.9	246.9	37,300*	74.1	244.8	34,600*	85
90	70.5	246.0	36,800	71.7	245.1	34,600*	72.8	243.0	32,200*	90
100	68.1	242.1	30,600	69.3	241.2	29,900*	70.4	239.1	28,000*	100
110	65.6	237.7	25,600	66.8	236.8	26,000*	67.9	234.6	24,500*	110
120	63.1	232.8	21,600	64.2	231.8	22,300	65.3	229.6	21,600*	120
130	60.5	227.3	18,200	61.6	226.3	18,800	62.7	224.0	18,900*	130
140	57.8	221.2	15,400	58.9	220.2	15,900	60.0	217.8	16,400	140
150	55.1	214.4	12,900	56.2	213.3	13,400	57.2	210.9	13,900	150
160	52.2	206.9	10,800	53.3	205.8	11,200	54.3	203.3	11,600	160
170	49.3	198.6	9,000	50.3	197.4	9,300	51.3	194.8	9,700	170
180	46.2	189.3	7,300	47.2	188.1	7,700	48.1	185.3	7,900	180
190	42.9	178.9	5,900	43.9	177.6	6,100	44.7	174.7	6,400	190
200	39.4	167.2	4,500	40.4	165.8	4,800	41.2	162.7	5,000	200
210	35.6	153.9	3,400	36.6	152.4	3,600	37.3	149.0	3,700	210
220	31.5	138.5	2,300	32.4	136.8	2,400	32.9	132.9	2,500	220

Liftcrane Jib Capacities

Meets
ANSI B30.5
Requirements

Jib No. 134 With 12 Ft. 6 in. Strut On
Boom No. 78T With Heavy Lift Top
95,400 Lb. Crane Counterweight
25,000 Lb. Front Bumper Counterweight
360 Degree Rating On Fully Extended Outriggers

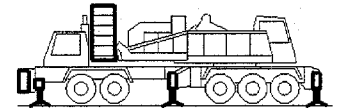

30 Ft. JIB

Jib Oper. Rad. Feet	5 Degree Offset			15 Degree Offset			25 Degree Offset			Jib Oper. Rad. Feet
	Boom Ang. Deg.	Jib Point Elev. Feet	Jib Capacity Pounds	Boom Ang. Deg.	Jib Point Elev. Feet	Jib Capacity Pounds	Boom Ang. Deg.	Jib Point Elev. Feet	Jib Capacity Pounds	
230 Ft. BOOM										
50	80.4	267.2	58,200*							50
55	79.2	266.2	57,600*	80.4	265.3	53,900*				55
60	78.1	265.2	57,000*	79.3	264.3	53,400*	80.4	262.3	46,900*	60
65	77.0	264.0	54,100*	78.1	263.1	53,000*	79.3	261.1	45,700*	65
70	75.9	262.7	49,700*	77.0	261.8	48,600*	78.2	259.8	43,800*	70
75	74.7	261.4	45,400*	75.9	260.5	44,600*	77.0	258.4	40,800*	75
80	73.6	259.9	41,800*	74.7	259.0	41,100*	75.9	256.9	37,700*	80
85	72.5	258.3	38,600*	73.6	257.4	38,000*	74.7	255.3	35,000*	85
90	71.3	256.6	35,800*	72.4	255.7	35,100*	73.5	253.6	32,600*	90
100	69.0	252.9	30,200	70.1	252.0	30,200*	71.2	249.9	28,300*	100
110	66.6	248.7	25,200	67.7	247.8	25,900*	68.8	245.6	24,700*	110
120	64.2	244.0	21,100	65.3	243.0	21,900	66.3	240.9	21,600*	120
130	61.7	238.8	17,800	62.8	237.8	18,400	63.8	235.5	18,500*	130
140	59.2	233.0	14,900	60.3	232.0	15,500	61.3	229.7	15,900*	140
150	56.6	226.6	12,500	57.7	225.5	13,000	58.6	223.2	13,400	150
160	53.9	219.5	10,300	55.0	218.4	10,800	55.9	216.0	11,200	160
170	51.2	211.7	8,500	52.2	210.6	8,900	53.1	208.0	9,200	170
180	48.3	203.0	6,800	49.3	201.9	7,200	50.1	199.2	7,500	180
190	45.2	193.4	5,400	46.2	192.2	5,700	47.1	189.4	6,000	190
200	42.0	182.7	4,100	43.0	181.4	4,300	43.8	178.4	4,600	200
210	38.6	170.7	2,900	39.6	169.3	3,100	40.3	166.1	3,300	210
220				35.8	155.5	2,000	36.4	152.0	2,100	220



777T

Liftcrane Jib Capacities

Jib No. 134 With 12 Ft. 6 in. Strut On
Boom No. 78T With Heavy Lift Top
95,400 Lb. Crane Counterweight
25,000 Lb. Front Bumper Counterweight
360 Degree Rating On Fully Extended Outriggers

Meets
ANSI B30.5
Requirements

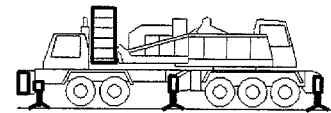

30 Ft. JIB

Jib Oper. Rad. Feet	5 Degree Offset			15 Degree Offset			25 Degree Offset			Jib Oper. Rad. Feet
	Boom Ang. Deg.	Jib Point Elev. Feet	Jib Capacity Pounds	Boom Ang. Deg.	Jib Point Elev. Feet	Jib Capacity Pounds	Boom Ang. Deg.	Jib Point Elev. Feet	Jib Capacity Pounds	
240 Ft. BOOM										
50	80.7	277.3	57,500*							50
55	79.6	276.4	55,800*	80.8	275.5	53,300*				55
60	78.6	275.4	53,300*	79.7	274.5	52,900*	80.8	272.5	47,300*	60
65	77.5	274.3	50,900*	78.6	273.4	51,500*	79.7	271.4	46,100*	65
70	76.4	273.1	47,700*	77.5	272.2	47,100*	78.6	270.1	44,400*	70
75	75.3	271.8	43,900*	76.4	270.9	43,500*	77.5	268.8	41,000*	75
80	74.2	270.3	40,100*	75.3	269.4	39,700*	76.4	267.4	38,000*	80
85	73.1	268.8	36,900*	74.2	267.9	36,700*	75.3	265.8	35,400*	85
90	72.0	267.2	34,000*	73.1	266.3	33,800*	74.2	264.2	32,700*	90
100	69.8	263.6	29,000*	70.9	262.7	28,700*	71.9	260.6	27,800*	100
110	67.5	259.6	24,700*	68.6	258.7	24,500*	69.6	256.5	23,800*	110
120	65.2	255.1	20,700	66.3	254.2	20,900*	67.3	252.0	20,300*	120
130	62.9	250.1	17,300	63.9	249.2	17,800*	64.9	246.9	17,300*	130
140	60.5	244.6	14,500	61.5	243.6	15,000*	62.5	241.3	14,800*	140
150	58.0	238.5	12,000	59.0	237.5	12,600	60.0	235.2	12,400*	150
160	55.5	231.8	9,900	56.5	230.8	10,400	57.4	228.3	10,300*	160
170	52.8	224.5	8,000	53.8	223.4	8,500	54.7	220.9	8,800	170
180	50.1	216.3	6,400	51.1	215.2	6,800	52.0	212.6	7,100	180
190	47.3	207.4	4,900	48.3	206.2	5,300	49.1	203.5	5,600	190
200	44.3	197.5	3,600	45.3	196.2	3,900	46.1	193.4	4,200	200
210	41.2	186.5	2,400	42.1	185.1	2,700	42.9	182.1	2,900	210



Liftcrane Jib Capacities

Meets
ANSI B30.5
Requirements

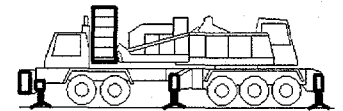

Jib No. 134 With 12 Ft. 6 in. Strut On
Boom No. 78T With Heavy Lift Top
95,400 Lb. Crane Counterweight
25,000 Lb. Front Bumper Counterweight
360 Degree Rating On Fully Extended Outriggers

40 Ft. JIB

Jib Oper. Rad. Feet	5 Degree Offset			15 Degree Offset			25 Degree Offset			Jib Oper. Rad. Feet
	Boom Ang. Deg.	Jib Point Elev. Feet	Jib Capacity Pounds	Boom Ang. Deg.	Jib Point Elev. Feet	Jib Capacity Pounds	Boom Ang. Deg.	Jib Point Elev. Feet	Jib Capacity Pounds	
100 Ft. BOOM										
30	80.9	148.8	53,500*							30
35	78.9	147.7	52,000*							35
40	76.8	146.5	50,600*	79.6	145.4	45,900*				40
45	74.7	145.1	49,300*	77.5	144.0	44,900*	80.4	141.6	37,500*	45
50	72.6	143.4	48,100*	75.4	142.3	43,900*	78.2	140.0	35,800*	50
55	70.4	141.6	46,900*	73.2	140.5	43,000*	76.0	138.1	34,200*	55
60	68.3	139.6	45,800*	71.0	138.4	42,200*	73.8	136.0	32,800*	60
65	66.1	137.3	44,800*	68.8	136.1	41,500*	71.5	133.6	31,500*	65
70	63.8	134.7	43,800*	66.5	133.6	40,800*	69.2	131.0	30,300*	70
75	61.5	132.0	43,000*	64.2	130.8	40,100*	66.8	128.2	29,200*	75
80	59.1	128.9	42,100*	61.8	127.7	39,500*	64.4	125.0	28,300*	80
85	56.7	125.6	41,400*	59.3	124.3	37,800*	61.9	121.6	27,400*	85
90	54.2	121.9	40,700*	56.8	120.6	36,100*	59.3	117.8	26,600*	90
100	48.9	113.5	35,500	51.5	112.1	33,300*	53.8	109.0	25,200*	100
110	43.2	103.3	30,500	45.6	101.7	31,000*	47.7	98.3	24,000*	110
120	36.7	90.6	26,500	39.0	88.8	26,800	40.8	84.7	23,100*	120
130	28.8	74.0	23,000	30.9	71.7	23,300	32.2	66.5	22,600*	130
140	17.9	48.9	20,100	19.4	45.0	20,200				140



777T

Liftcrane Jib Capacities

Jib No. 134 With 12 Ft. 6 in. Strut On
Boom No. 78T With Heavy Lift Top
95,400 Lb. Crane Counterweight
25,000 Lb. Front Bumper Counterweight
360 Degree Rating On Fully Extended Outriggers

Meets
ANSI B30.5
Requirements

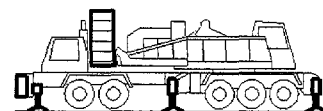

40 Ft. JIB

Jib Oper. Rad. Feet	5 Degree Offset			15 Degree Offset			25 Degree Offset			Jib Oper. Rad. Feet
	Boom Ang. Deg.	Jib Point Elev. Feet	Jib Capacity Pounds	Boom Ang. Deg.	Jib Point Elev. Feet	Jib Capacity Pounds	Boom Ang. Deg.	Jib Point Elev. Feet	Jib Capacity Pounds	
110 Ft. BOOM										
35	79.6	158.0	52,600*							35
40	77.7	156.8	51,200*	80.3	155.7	46,200*				40
45	75.7	155.5	49,900*	78.4	154.4	45,300*				45
50	73.8	154.0	48,700*	76.4	152.9	44,400*	79.1	150.4	36,300*	50
55	71.8	152.3	47,600*	74.4	151.2	43,500*	77.0	148.7	34,800*	55
60	69.8	150.4	46,600*	72.4	149.2	42,700*	75.0	146.8	33,400*	60
65	67.7	148.3	45,600*	70.3	147.1	42,000*	72.9	144.6	32,200*	65
70	65.7	146.0	44,600*	68.2	144.8	41,300*	70.7	142.2	31,000*	70
75	63.5	143.4	43,700*	66.1	142.2	40,600*	68.6	139.6	30,000*	75
80	61.4	140.6	42,900*	63.9	139.4	40,000*	66.3	136.7	29,000*	80
85	59.2	137.6	42,200*	61.7	136.3	39,500*	64.1	133.6	28,100*	85
90	56.9	134.3	41,300	59.4	133.0	37,800*	61.7	130.2	27,300*	90
100	52.2	126.7	35,100	54.6	125.4	34,900*	56.8	122.4	25,900*	100
110	47.2	117.8	30,200	49.5	116.3	30,800	51.6	113.0	24,700*	110
120	41.6	107.0	26,200	43.9	105.3	26,600	45.8	101.7	23,700*	120
130	35.3	93.7	22,800	37.5	91.7	23,100	39.1	87.5	22,900*	130
140	27.8	76.3	19,900	29.7	73.9	20,100	30.7	68.4	20,200	140
150	17.3	50.2	17,300	18.5	46.1	17,400				150



Liftcrane Jib Capacities

Meets
 ANSI B30.5
 Requirements

Jib No. 134 With 12 Ft. 6 in. Strut On
 Boom No. 78T With Heavy Lift Top
 95,400 Lb. Crane Counterweight
 25,000 Lb. Front Bumper Counterweight
 360 Degree Rating On Fully Extended Outriggers

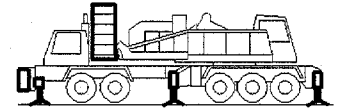

40 Ft. JIB

Jib Oper. Rad. Feet	5 Degree Offset			15 Degree Offset			25 Degree Offset			Jib Oper. Rad. Feet
	Boom Ang. Deg.	Jib Point Elev. Feet	Jib Capacity Pounds	Boom Ang. Deg.	Jib Point Elev. Feet	Jib Capacity Pounds	Boom Ang. Deg.	Jib Point Elev. Feet	Jib Capacity Pounds	
120 Ft. BOOM										
35	80.3	168.2	53,100*							35
40	78.5	167.1	51,800*	80.9	166.0	46,500*				40
45	76.7	165.9	50,500*	79.1	164.7	45,600*				45
50	74.8	164.4	49,400*	77.3	163.3	44,700*	79.8	160.9	36,900*	50
55	73.0	162.9	48,300*	75.4	161.7	43,900*	77.9	159.2	35,400*	55
60	71.1	161.1	47,200*	73.5	159.9	43,200*	76.0	157.4	34,100*	60
65	69.2	159.1	46,300*	71.6	158.0	42,400*	74.0	155.4	32,800*	65
70	67.3	157.0	45,300*	69.7	155.8	41,700*	72.0	153.2	31,700*	70
75	65.3	154.6	44,500*	67.7	153.4	41,100*	70.0	150.8	30,600*	75
80	63.3	152.1	43,700*	65.7	150.8	40,500*	68.0	148.2	29,700*	80
85	61.3	149.3	42,900*	63.7	148.0	39,900*	65.9	145.3	28,800*	85
90	59.2	146.3	41,200	61.6	145.0	39,400*	63.8	142.2	28,000*	90
100	55.0	139.4	35,100	57.2	138.1	35,800	59.4	135.1	26,500*	100
110	50.4	131.4	30,100	52.7	129.9	30,700	54.7	126.8	25,300*	110
120	45.6	121.9	26,100	47.7	120.3	26,600	49.6	116.9	24,300*	120
130	40.2	110.6	22,700	42.3	108.8	23,100	44.0	105.0	23,400*	130
140	34.2	96.6	19,900	36.1	94.6	20,200	37.5	90.1	20,400	140
150	26.9	78.6	17,400	28.6	76.1	17,600	29.5	70.2	17,700	150
160	16.7	51.6	15,100	17.8	47.3	15,200				160



777T

Liftcrane Jib Capacities

Meets
ANSI B30.5
Requirements

Jib No. 134 With 12 Ft. 6 in. Strut On
Boom No. 78T With Heavy Lift Top
95,400 Lb. Crane Counterweight
25,000 Lb. Front Bumper Counterweight
360 Degree Rating On Fully Extended Outriggers

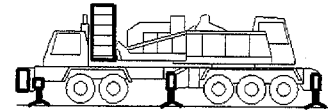

40 Ft. JIB

Jib Oper. Rad. Feet	5 Degree Offset			15 Degree Offset			25 Degree Offset			Jib Oper. Rad. Feet
	Boom Ang. Deg.	Jib Point Elev. Feet	Jib Capacity Pounds	Boom Ang. Deg.	Jib Point Elev. Feet	Jib Capacity Pounds	Boom Ang. Deg.	Jib Point Elev. Feet	Jib Capacity Pounds	
130 Ft. BOOM										
35	80.8	178.3	53,500*							35
40	79.2	177.3	52,200*							40
45	77.4	176.2	51,100*	79.8	175.0	45,900*				45
50	75.7	174.8	49,900*	78.0	173.7	45,100*	80.4	171.2	37,400*	50
55	74.0	173.4	48,900*	76.3	172.2	44,300*	78.6	169.7	35,900*	55
60	72.2	171.7	47,900*	74.5	170.5	43,600*	76.8	168.0	34,600*	60
65	70.5	169.9	46,900*	72.7	168.7	42,800*	75.0	166.1	33,400*	65
70	68.7	167.9	46,000*	70.9	166.7	42,200*	73.2	164.1	32,300*	70
75	66.9	165.7	45,200*	69.1	164.5	41,600*	71.3	161.9	31,300*	75
80	65.0	163.3	44,300*	67.2	162.1	41,000*	69.4	159.4	30,300*	80
85	63.1	160.7	43,600*	65.4	159.5	40,400*	67.5	156.8	29,500*	85
90	61.2	157.9	40,800	63.4	156.7	39,900*	65.6	153.9	28,600*	90
100	57.3	151.7	34,700	59.5	150.3	35,400	61.5	147.4	27,200*	100
110	53.2	144.4	29,700	55.3	143.0	30,400	57.3	139.9	25,900*	110
120	48.8	135.8	25,700	50.9	134.3	26,200	52.7	131.1	24,900*	120
130	44.1	125.9	22,300	46.1	124.2	22,800	47.8	120.7	23,200	130
140	38.9	114.0	19,500	40.9	112.2	19,800	42.4	108.2	20,100	140
150	33.1	99.5	17,000	34.9	97.4	17,300	36.1	92.7	17,400	150
160	26.0	80.8	14,800	27.6	78.2	15,000	28.3	72.0	15,100	160
170	16.1	52.9	12,800	17.1	48.3	12,900				170



Liftcrane Jib Capacities

Meets
ANSI B30.5
Requirements

Jib No. 134 With 12 Ft. 6 in. Strut On
Boom No. 78T With Heavy Lift Top
95,400 Lb. Crane Counterweight
25,000 Lb. Front Bumper Counterweight
360 Degree Rating On Fully Extended Outriggers

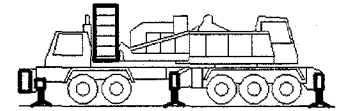

40 Ft. JIB

Jib Oper. Rad. Feet	5 Degree Offset			15 Degree Offset			25 Degree Offset			Jib Oper. Rad. Feet
	Boom Ang. Deg.	Jib Point Elev. Feet	Jib Capacity Pounds	Boom Ang. Deg.	Jib Point Elev. Feet	Jib Capacity Pounds	Boom Ang. Deg.	Jib Point Elev. Feet	Jib Capacity Pounds	
140 Ft. BOOM										
40	79.8	187.6	52,700*							40
45	78.1	186.5	51,500*	80.3	185.3	46,200*				45
50	76.5	185.2	50,500*	78.7	184.1	45,400*	81.0	181.5	37,800*	50
55	74.9	183.8	49,400*	77.1	182.6	44,600*	79.3	180.1	36,400*	55
60	73.2	182.3	48,500*	75.4	181.1	43,900*	77.6	178.5	35,100*	60
65	71.6	180.6	47,500*	73.7	179.4	43,200*	75.9	176.8	34,000*	65
70	69.9	178.7	46,600*	72.0	177.5	42,600*	74.2	174.9	32,900*	70
75	68.2	176.6	45,800*	70.3	175.4	42,000*	72.5	172.8	31,900*	75
80	66.5	174.4	45,000*	68.6	173.2	41,400*	70.7	170.5	30,900*	80
85	64.7	172.0	43,400*	66.8	170.7	40,800*	68.9	168.0	30,100*	85
90	63.0	169.4	40,500	65.1	168.1	39,500*	67.1	165.4	29,300*	90
100	59.3	163.6	34,300	61.4	162.3	34,700*	63.4	159.4	27,800*	100
110	55.5	156.9	29,300	57.6	155.5	30,000	59.5	152.5	26,500*	110
120	51.6	149.1	25,300	53.5	147.7	25,900	55.3	144.5	25,400*	120
130	47.3	140.2	21,900	49.3	138.6	22,400	51.0	135.2	22,900	130
140	42.8	129.7	19,100	44.7	128.0	19,500	46.2	124.3	19,800	140
150	37.8	117.3	16,600	39.6	115.5	16,900	41.0	111.3	17,200	150
160	32.1	102.3	14,500	33.8	100.1	14,700	34.9	95.2	14,900	160
170	25.2	83.0	12,600	26.7	80.2	12,700				170
180	15.6	54.1	10,800							180



777T

Liftcrane Jib Capacities

Meets
ANSI B30.5
Requirements

Jib No. 134 With 12 Ft. 6 in. Strut On
Boom No. 78T With Heavy Lift Top
95,400 Lb. Crane Counterweight
25,000 Lb. Front Bumper Counterweight
360 Degree Rating On Fully Extended Outriggers

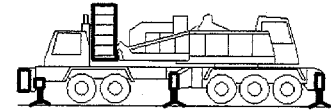

40 Ft. JIB

Jib Oper. Rad. Feet	5 Degree Offset			15 Degree Offset			25 Degree Offset			Jib Oper. Rad. Feet
	Boom Ang. Deg.	Jib Point Elev. Feet	Jib Capacity Pounds	Boom Ang. Deg.	Jib Point Elev. Feet	Jib Capacity Pounds	Boom Ang. Deg.	Jib Point Elev. Feet	Jib Capacity Pounds	
150 Ft. BOOM										
40	80.3	197.7	52,800*							40
45	78.8	196.7	51,900*	80.9	195.5	46,500*				45
50	77.2	195.5	50,900*	79.3	194.4	45,700*				50
55	75.7	194.2	49,900*	77.8	193.0	45,000*	79.9	190.5	36,900*	55
60	74.1	192.7	48,900*	76.2	191.6	44,200*	78.3	189.0	35,600*	60
65	72.6	191.1	48,000*	74.6	189.9	43,600*	76.7	187.3	34,500*	65
70	71.0	189.4	47,200*	73.0	188.2	42,900*	75.1	185.5	33,400*	70
75	69.4	187.4	46,300*	71.4	186.2	42,300*	73.5	183.6	32,400*	75
80	67.8	185.4	45,600*	69.8	184.1	41,800*	71.8	181.4	31,500*	80
85	66.2	183.1	43,600	68.2	181.8	41,200*	70.1	179.1	30,600*	85
90	64.5	180.7	39,900	66.5	179.4	38,600*	68.4	176.6	29,800*	90
100	61.1	175.3	33,700	63.1	173.9	34,000*	65.0	171.1	28,400*	100
110	57.6	169.0	28,700	59.5	167.7	29,500	61.3	164.7	27,100*	110
120	53.9	161.9	24,700	55.8	160.5	25,300	57.6	157.4	25,800*	120
130	50.1	153.7	21,300	51.9	152.2	21,800	53.6	148.9	22,300	130
140	46.0	144.3	18,400	47.8	142.7	18,900	49.4	139.2	19,300	140
150	41.6	133.4	16,000	43.3	131.7	16,400	44.8	127.8	16,700	150
160	36.7	120.6	13,800	38.4	118.6	14,100	39.6	114.3	14,400	160
170	31.2	105.0	11,900	32.8	102.7	12,200	33.7	97.6	12,300	170
180	24.5	85.1	10,200	25.9	82.1	10,400				180
190	15.2	55.4	8,700							190



Liftcrane Jib Capacities

Meets
 ANSI B30.5
 Requirements

Jib No. 134 With 12 Ft. 6 in. Strut On
 Boom No. 78T With Heavy Lift Top
 95,400 Lb. Crane Counterweight
 25,000 Lb. Front Bumper Counterweight
 360 Degree Rating On Fully Extended Outriggers

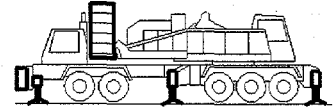

40 Ft. JIB

Jib Oper. Rad. Feet	5 Degree Offset			15 Degree Offset			25 Degree Offset			Jib Oper. Rad. Feet
	Boom Ang. Deg.	Jib Point Elev. Feet	Jib Capacity Pounds	Boom Ang. Deg.	Jib Point Elev. Feet	Jib Capacity Pounds	Boom Ang. Deg.	Jib Point Elev. Feet	Jib Capacity Pounds	
160 Ft. BOOM										
40	80.8	207.9	52,600*							40
45	79.3	206.9	51,800*							45
50	77.9	205.8	51,000*	79.9	204.6	46,000*				50
55	76.4	204.6	50,200*	78.4	203.4	45,200*	80.4	200.8	37,300*	55
60	75.0	203.2	49,400*	76.9	202.0	44,500*	78.9	199.4	36,100*	60
65	73.5	201.7	48,500*	75.4	200.5	43,900*	77.4	197.8	34,900*	65
70	72.0	200.0	47,700*	73.9	198.8	43,300*	75.9	196.1	33,900*	70
75	70.5	198.2	46,900*	72.4	196.9	42,700*	74.3	194.3	32,900*	75
80	68.9	196.2	45,200*	70.9	195.0	41,500*	72.8	192.3	32,000*	80
85	67.4	194.1	41,700*	69.3	192.8	38,700*	71.2	190.1	31,200*	85
90	65.9	191.8	38,700*	67.8	190.5	36,200*	69.6	187.8	30,400*	90
100	62.7	186.7	33,300	64.5	185.4	31,600*	66.4	182.6	28,900*	100
110	59.4	180.9	28,300	61.2	179.6	27,800*	63.0	176.6	26,600*	110
120	56.0	174.3	24,200	57.8	172.9	24,600*	59.5	169.8	23,800*	120
130	52.4	166.8	20,900	54.2	165.3	21,500	55.9	162.1	21,300*	130
140	48.7	158.2	18,000	50.5	156.6	18,500	52.0	153.2	19,000	140
150	44.7	148.4	15,500	46.5	146.7	16,000	47.9	143.0	16,400	150
160	40.5	137.0	13,400	42.1	135.2	13,800	43.4	131.2	14,100	160
170	35.7	123.7	11,500	37.3	121.7	11,800	38.4	117.2	12,000	170
180	30.4	107.6	9,800	31.8	105.3	10,100	32.7	99.9	10,200	180
190	23.9	87.1	8,300	25.1	84.1	8,500				190
200	14.8	56.6	6,900							200



777T

Liftcrane Jib Capacities

Jib No. 134 With 12 Ft. 6 in. Strut On
Boom No. 78T With Heavy Lift Top
95,400 Lb. Crane Counterweight
25,000 Lb. Front Bumper Counterweight
360 Degree Rating On Fully Extended Outriggers

Meets
ANSI B30.5
Requirements

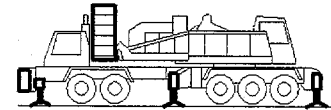

40 Ft. JIB

Jib Oper. Rad. Feet	5 Degree Offset			15 Degree Offset			25 Degree Offset			Jib Oper. Rad. Feet
	Boom Ang. Deg.	Jib Point Elev. Feet	Jib Capacity Pounds	Boom Ang. Deg.	Jib Point Elev. Feet	Jib Capacity Pounds	Boom Ang. Deg.	Jib Point Elev. Feet	Jib Capacity Pounds	
170 Ft. BOOM										
45	79.8	217.1	51,500*							45
50	78.5	216.1	50,800*	80.4	214.9	46,200*				50
55	77.1	214.9	50,100*	79.0	213.7	45,500*	80.9	211.1	37,700*	55
60	75.7	213.6	49,400*	77.6	212.4	44,800*	79.5	209.8	36,500*	60
65	74.3	212.1	48,700*	76.1	210.9	44,200*	78.0	208.3	35,400*	65
70	72.9	210.5	48,000*	74.7	209.3	42,600*	76.6	206.7	34,400*	70
75	71.4	208.8	46,800*	73.3	207.6	40,400*	75.1	204.9	33,400*	75
80	70.0	207.0	42,800*	71.8	205.7	38,500*	73.7	203.0	32,500*	80
85	68.5	205.0	39,600*	70.4	203.7	36,600*	72.2	201.0	31,700*	85
90	67.1	202.8	36,500*	68.9	201.5	34,100*	70.7	198.8	30,900*	90
100	64.1	198.0	31,500*	65.9	196.7	29,700*	67.6	193.9	28,300*	100
110	61.0	192.6	27,500*	62.8	191.2	26,100*	64.5	188.3	25,000*	110
120	57.8	186.4	24,000	59.6	185.0	23,000*	61.2	182.0	22,200*	120
130	54.5	179.4	20,700	56.2	177.9	20,400*	57.8	174.8	19,800*	130
140	51.1	171.5	17,800	52.8	170.0	18,300*	54.3	166.7	17,800*	140
150	47.5	162.5	15,400	49.1	160.9	15,800	50.5	157.4	15,900*	150
160	43.6	152.3	13,200	45.2	150.6	13,600	46.5	146.8	14,000	160
170	39.4	140.6	11,400	41.0	138.7	11,700	42.2	134.5	12,000	170
180	34.8	126.8	9,700	36.3	124.7	10,000	37.3	120.0	10,200	180
190	29.6	110.2	8,200	31.0	107.8	8,400	31.7	102.2	8,500	190
200	23.3	89.1	6,800	24.4	85.9	7,000				200
210	14.4	57.7	5,600							210



Liftcrane Jib Capacities

Jib No. 134 With 12 Ft. 6 in. Strut On
 Boom No. 78T With Heavy Lift Top
 95,400 Lb. Crane Counterweight
 25,000 Lb. Front Bumper Counterweight
 360 Degree Rating On Fully Extended Outriggers

Meets
ANSI B30.5
Requirements

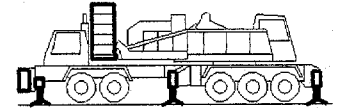

40 Ft. JIB

Jib Oper. Rad. Feet	5 Degree Offset			15 Degree Offset			25 Degree Offset			Jib Oper. Rad. Feet
	Boom Ang. Deg.	Jib Point Elev. Feet	Jib Capacity Pounds	Boom Ang. Deg.	Jib Point Elev. Feet	Jib Capacity Pounds	Boom Ang. Deg.	Jib Point Elev. Feet	Jib Capacity Pounds	
180 Ft. BOOM										
45	80.3	227.3	51,300*							45
50	79.0	226.3	50,600*	80.8	225.1	46,400*				50
55	77.7	225.2	49,900*	79.5	224.0	45,700*				55
60	76.3	223.9	49,200*	78.1	222.7	45,100*	80.0	220.1	36,900*	60
65	75.0	222.6	48,600*	76.8	221.3	44,500*	78.6	218.7	35,800*	65
70	73.7	221.1	48,000*	75.4	219.8	43,900*	77.2	217.1	34,800*	70
75	72.3	219.4	47,400*	74.1	218.2	43,300*	75.8	215.5	33,900*	75
80	70.9	217.6	43,800*	72.7	216.4	40,400*	74.4	213.7	33,000*	80
85	69.6	215.7	40,500*	71.3	214.5	37,300*	73.0	211.7	32,100*	85
90	68.2	213.7	37,400*	69.9	212.4	34,700*	71.6	209.7	31,400*	90
100	65.3	209.2	32,300*	67.1	207.9	30,200*	68.7	205.0	28,600*	100
110	62.4	204.0	27,700	64.1	202.7	26,500*	65.8	199.8	25,200*	110
120	59.4	198.2	23,600	61.1	196.9	23,400*	62.7	193.9	22,400*	120
130	56.4	191.7	20,200	58.0	190.3	20,700*	59.6	187.2	20,000*	130
140	53.2	184.4	17,400	54.8	182.9	17,900	56.3	179.6	17,900*	140
150	49.8	176.1	14,900	51.4	174.5	15,400	52.8	171.1	15,900	150
160	46.3	166.8	12,800	47.9	165.1	13,200	49.2	161.5	13,600	160
170	42.5	156.2	10,900	44.1	154.4	11,300	45.3	150.5	11,600	170
180	38.5	144.0	9,200	39.9	142.0	9,600	41.0	137.8	9,800	180
190	34.0	129.8	7,700	35.4	127.6	8,000	36.3	122.8	8,200	190
200	28.9	112.7	6,400	30.2	110.2	6,600	30.8	104.5	6,700	200
210	22.7	91.0	5,200	23.8	87.8	5,300				210
220	14.0	58.9	4,000							220



777T

Liftcrane Jib Capacities

Meets
ANSI B30.5
Requirements

Jib No. 134 With 12 Ft. 6 in. Strut On
Boom No. 78T With Heavy Lift Top
95,400 Lb. Crane Counterweight
25,000 Lb. Front Bumper Counterweight
360 Degree Rating On Fully Extended Outriggers

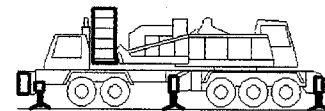

40 Ft. JIB

Jib Oper. Rad. Feet	5 Degree Offset			15 Degree Offset			25 Degree Offset			Jib Oper. Rad. Feet
	Boom Ang. Deg.	Jib Point Elev. Feet	Jib Capacity Pounds	Boom Ang. Deg.	Jib Point Elev. Feet	Jib Capacity Pounds	Boom Ang. Deg.	Jib Point Elev. Feet	Jib Capacity Pounds	
190 Ft. BOOM										
45	80.7	237.5	51,000*							45
50	79.5	236.5	50,300*							50
55	78.2	235.5	49,700*	79.9	234.2	46,000*				55
60	76.9	234.3	49,000*	78.7	233.0	45,400*	80.4	230.4	37,200*	60
65	75.7	232.9	48,400*	77.4	231.7	44,800*	79.1	229.0	36,200*	65
70	74.4	231.5	47,800*	76.1	230.3	44,200*	77.8	227.6	35,200*	70
75	73.1	230.0	47,300*	74.8	228.7	43,600*	76.5	226.0	34,300*	75
80	71.8	228.3	44,100*	73.5	227.0	40,800*	75.2	224.3	33,400*	80
85	70.5	226.5	40,900*	72.2	225.2	37,900*	73.8	222.4	32,600*	85
90	69.2	224.5	37,900*	70.8	223.2	35,500*	72.5	220.5	31,800*	90
100	66.5	220.2	32,200	68.1	218.9	30,900*	69.7	216.1	29,100*	100
110	63.7	215.4	27,200	65.4	214.0	27,000*	66.9	211.1	25,700*	110
120	60.9	209.9	23,200	62.5	208.5	23,900*	64.1	205.5	22,800*	120
130	58.0	203.7	19,800	59.6	202.3	20,500	61.1	199.2	20,300*	130
140	55.0	196.9	16,900	56.6	195.4	17,600	58.0	192.2	18,100	140
150	51.9	189.2	14,500	53.5	187.6	15,000	54.8	184.3	15,500	150
160	48.6	180.6	12,300	50.2	178.9	12,800	51.5	175.4	13,200	160
170	45.2	170.9	10,500	46.7	169.2	10,900	47.9	165.4	11,200	170
180	41.5	159.9	8,800	43.0	158.1	9,200	44.1	154.0	9,400	180
190	37.6	147.3	7,300	39.0	145.3	7,600	40.0	140.9	7,800	190
200	33.2	132.7	6,000	34.5	130.5	6,200	35.4	125.5	6,400	200
210	28.2	115.2	4,800	29.4	112.5	5,000	30.0	106.7	5,000	210
220	22.2	92.9	3,700	23.2	89.5	3,800				220
230	13.7	60.0	2,600							230



Liftcrane Jib Capacities

Meets
ANSI B30.5
Requirements

Jib No. 134 With 12 Ft. 6 in. Strut On
Boom No. 78T With Heavy Lift Top
95,400 Lb. Crane Counterweight
25,000 Lb. Front Bumper Counterweight
360 Degree Rating On Fully Extended Outriggers

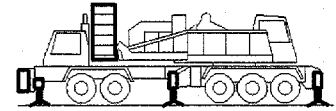

40 Ft. JIB

Jib Oper. Rad. Feet	5 Degree Offset			15 Degree Offset			25 Degree Offset			Jib Oper. Rad. Feet
	Boom Ang. Deg.	Jib Point Elev. Feet	Jib Capacity Pounds	Boom Ang. Deg.	Jib Point Elev. Feet	Jib Capacity Pounds	Boom Ang. Deg.	Jib Point Elev. Feet	Jib Capacity Pounds	
200 Ft. BOOM										
50	79.9	246.7	49,900*							50
55	78.7	245.7	49,300*	80.4	244.5	46,200*				55
60	77.5	244.5	48,700*	79.1	243.3	45,600*	80.8	240.7	37,600*	60
65	76.3	243.3	48,200*	77.9	242.1	45,000*	79.6	239.4	36,500*	65
70	75.0	241.9	47,600*	76.7	240.7	44,500*	78.3	238.0	35,600*	70
75	73.8	240.4	45,800*	75.4	239.2	43,900*	77.1	236.5	34,700*	75
80	72.6	238.8	42,500*	74.2	237.6	41,800*	75.8	234.8	33,800*	80
85	71.3	237.1	39,100*	72.9	235.8	38,600*	74.5	233.1	33,000*	85
90	70.1	235.3	36,300*	71.7	234.0	35,600*	73.3	231.2	32,200*	90
100	67.5	231.2	31,300*	69.1	229.9	30,800*	70.7	227.0	29,300*	100
110	64.9	226.6	26,800	66.5	225.2	26,700*	68.0	222.3	25,600*	110
120	62.2	221.4	22,700	63.8	220.0	23,200*	65.3	217.0	22,300*	120
130	59.5	215.6	19,300	61.0	214.2	20,100	62.5	211.1	19,500*	130
140	56.7	209.1	16,400	58.2	207.6	17,100	59.6	204.5	16,900*	140
150	53.8	201.9	14,000	55.3	200.4	14,600	56.6	197.1	14,700*	150
160	50.7	193.9	11,800	52.2	192.3	12,400	53.5	188.9	12,700*	160
170	47.5	184.9	10,000	49.0	183.3	10,400	50.2	179.7	10,800	170
180	44.2	174.9	8,300	45.6	173.1	8,700	46.8	169.3	9,000	180
190	40.6	163.5	6,800	42.0	161.7	7,200	43.1	157.5	7,400	190
200	36.7	150.6	5,500	38.1	148.5	5,800	39.0	144.0	6,000	200
210	32.5	135.6	4,300	33.7	133.2	4,500	34.5	128.1	4,700	210
220	27.6	117.5	3,200	28.7	114.9	3,400	29.3	108.8	3,400	220
230	21.7	94.7	2,200	22.6	91.3	2,300				230



777T

Liftcrane Jib Capacities

Meets
 ANSI B30.5
 Requirements

Jib No. 134 With 12 Ft. 6 in. Strut On
 Boom No. 78T With Heavy Lift Top
 95,400 Lb. Crane Counterweight
 25,000 Lb. Front Bumper Counterweight
 360 Degree Rating On Fully Extended Outriggers

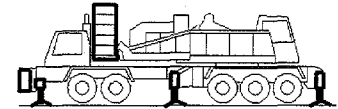

40 Ft. JIB

Jib Oper. Rad. Feet	5 Degree Offset			15 Degree Offset			25 Degree Offset			Jib Oper. Rad. Feet
	Boom Ang. Deg.	Jib Point Elev. Feet	Jib Capacity Pounds	Boom Ang. Deg.	Jib Point Elev. Feet	Jib Capacity Pounds	Boom Ang. Deg.	Jib Point Elev. Feet	Jib Capacity Pounds	
210 Ft. BOOM										
50	80.3	256.9	49,400*							50
55	79.2	255.9	48,800*	80.8	254.7	45,800*				55
60	78.0	254.8	48,200*	79.6	253.6	44,200*				60
65	76.8	253.6	47,600*	78.4	252.4	42,100*	80.0	249.7	34,500*	65
70	75.7	252.3	47,100*	77.2	251.1	40,200*	78.8	248.3	33,300*	70
75	74.5	250.9	44,500*	76.0	249.6	38,400*	77.6	246.9	32,100*	75
80	73.3	249.3	40,600*	74.8	248.1	36,700*	76.4	245.3	31,100*	80
85	72.1	247.7	37,300*	73.6	246.4	34,000*	75.2	243.7	30,000*	85
90	70.9	245.9	34,400*	72.4	244.6	31,600*	74.0	241.9	29,000*	90
100	68.4	242.0	29,500*	70.0	240.7	27,300*	71.5	237.9	25,500*	100
110	66.0	237.6	25,500*	67.5	236.3	23,800*	69.0	233.4	22,400*	110
120	63.4	232.7	22,200*	64.9	231.3	20,800*	66.4	228.4	19,700*	120
130	60.8	227.2	19,000	62.3	225.8	18,400*	63.7	222.8	17,400*	130
140	58.2	221.1	16,100	59.6	219.7	16,200*	61.0	216.5	15,500*	140
150	55.4	214.3	13,600	56.9	212.8	14,200*	58.2	209.6	13,700*	150
160	52.6	206.8	11,500	54.0	205.2	12,100	55.3	201.9	12,000*	160
170	49.6	198.4	9,600	51.0	196.8	10,100	52.2	193.3	10,600	170
180	46.5	189.2	8,000	47.9	187.5	8,400	49.1	183.8	8,800	180
190	43.2	178.8	6,500	44.6	177.0	6,900	45.7	173.1	7,200	190
200	39.8	167.1	5,200	41.1	165.2	5,500	42.0	160.9	5,800	200
210	36.0	153.8	4,000	37.2	151.7	4,300	38.1	147.0	4,400	210
220	31.8	138.3	2,900	33.0	136.0	3,100	33.7	130.7	3,200	220
230				28.1	117.1	2,000	28.6	110.9	2,100	230

Liftcrane Jib Capacities

Meets
ANSI B30.5
Requirements

Jib No. 134 With 12 Ft. 6 in. Strut On
Boom No. 78T With Heavy Lift Top
95,400 Lb. Crane Counterweight
25,000 Lb. Front Bumper Counterweight
360 Degree Rating On Fully Extended Outriggers

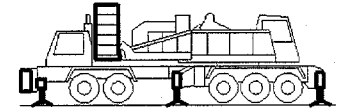

40 Ft. JIB

Jib Oper. Rad. Feet	5 Degree Offset			15 Degree Offset			25 Degree Offset			Jib Oper. Rad. Feet
	Boom Ang. Deg.	Jib Point Elev. Feet	Jib Capacity Pounds	Boom Ang. Deg.	Jib Point Elev. Feet	Jib Capacity Pounds	Boom Ang. Deg.	Jib Point Elev. Feet	Jib Capacity Pounds	
220 Ft. BOOM										
50	80.7	267.1	48,900*							50
55	79.6	266.1	48,300*							55
60	78.5	265.1	47,800*	80.0	263.8	45,000*				60
65	77.3	263.9	47,300*	78.9	262.7	44,000*	80.4	260.0	35,500*	65
70	76.2	262.7	46,700*	77.7	261.4	42,100*	79.3	258.7	34,500*	70
75	75.1	261.3	45,700*	76.6	260.0	40,300*	78.1	257.3	33,400*	75
80	73.9	259.8	41,700*	75.4	258.6	37,400*	77.0	255.8	32,400*	80
85	72.8	258.2	38,300*	74.3	257.0	34,600*	75.8	254.2	31,500*	85
90	71.6	256.5	35,400*	73.1	255.3	32,200*	74.6	252.5	29,600*	90
100	69.3	252.8	30,300*	70.8	251.5	27,900*	72.2	248.7	25,900*	100
110	66.9	248.6	26,200	68.4	247.3	24,300*	69.8	244.4	22,700*	110
120	64.5	243.9	22,100	66.0	242.6	21,300*	67.4	239.6	20,100*	120
130	62.1	238.7	18,700	63.5	237.3	18,800*	64.9	234.3	17,800*	130
140	59.5	232.9	15,800	61.0	231.5	16,400*	62.3	228.4	15,800*	140
150	56.9	226.5	13,400	58.3	225.0	14,000	59.6	221.8	14,000*	150
160	54.3	219.4	11,200	55.6	217.9	11,800	56.9	214.6	12,400	160
170	51.5	211.6	9,400	52.8	210.0	9,900	54.0	206.6	10,400	170
180	48.6	202.9	7,700	49.9	201.3	8,200	51.1	197.7	8,600	180
190	45.6	193.3	6,300	46.9	191.6	6,700	48.0	187.8	7,000	190
200	42.4	182.6	4,900	43.6	180.8	5,300	44.7	176.7	5,600	200
210	38.9	170.6	3,700	40.2	168.6	4,000	41.1	164.3	4,300	210
220	35.2	156.9	2,600	36.4	154.7	2,900	37.2	150.0	3,100	220
230							32.9	133.3	2,000	230



777T

Liftcrane Jib Capacities

Jib No. 134 With 12 Ft. 6 in. Strut On
Boom No. 78T With Heavy Lift Top
95,400 Lb. Crane Counterweight
25,000 Lb. Front Bumper Counterweight
360 Degree Rating On Fully Extended Outriggers

Meets
ANSI B30.5
Requirements

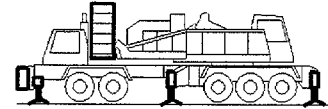

40 Ft. JIB

Jib Oper. Rad. Feet	5 Degree Offset			15 Degree Offset			25 Degree Offset			Jib Oper. Rad. Feet
	Boom Ang. Deg.	Jib Point Elev. Feet	Jib Capacity Pounds	Boom Ang. Deg.	Jib Point Elev. Feet	Jib Capacity Pounds	Boom Ang. Deg.	Jib Point Elev. Feet	Jib Capacity Pounds	
230 Ft. BOOM										
50	81.0	277.2	48,300*							50
55	80.0	276.3	47,800*							55
60	78.9	275.3	47,300*	80.4	274.1	44,600*				60
65	77.8	274.2	46,800*	79.3	272.9	44,200*	80.8	270.2	36,500*	65
70	76.7	273.0	46,300*	78.2	271.7	43,900*	79.7	269.0	35,500*	70
75	75.6	271.7	45,600*	77.1	270.4	40,900*	78.6	267.7	34,600*	75
80	74.6	270.3	42,000*	76.0	269.0	37,800*	77.5	266.2	33,600*	80
85	73.5	268.7	38,800*	74.9	267.5	35,000*	76.3	264.7	31,800*	85
90	72.3	267.1	35,800*	73.8	265.8	32,500*	75.2	263.0	29,700*	90
100	70.1	263.5	30,700*	71.5	262.2	28,200*	72.9	259.4	26,000*	100
110	67.8	259.5	25,700	69.3	258.2	24,600*	70.6	255.3	22,900*	110
120	65.5	255.0	21,700	66.9	253.7	21,600*	68.3	250.7	20,300*	120
130	63.2	250.0	18,300	64.6	248.7	18,900*	65.9	245.7	17,900*	130
140	60.8	244.5	15,400	62.1	243.1	16,100	63.4	240.0	15,900*	140
150	58.3	238.4	12,900	59.7	237.0	13,600	60.9	233.8	13,800*	150
160	55.8	231.7	10,800	57.1	230.2	11,400	58.3	227.0	11,700*	160
170	53.2	224.4	8,900	54.5	222.8	9,400	55.7	219.4	9,900	170
180	50.4	216.2	7,200	51.8	214.6	7,700	52.9	211.1	8,200	180
190	47.6	207.3	5,800	48.9	205.6	6,200	50.0	201.9	6,600	190
200	44.7	197.4	4,400	45.9	195.6	4,800	46.9	191.7	5,200	200
210	41.5	186.3	3,300	42.7	184.5	3,600	43.7	180.4	3,900	210
220	38.2	174.0	2,200	39.4	172.0	2,500	40.2	167.5	2,700	220



Liftcrane Jib Capacities

Meets
ANSI B30.5
Requirements

Jib No. 134 With 12 Ft. 6 in. Strut On
Boom No. 78T With Heavy Lift Top
95,400 Lb. Crane Counterweight
25,000 Lb. Front Bumper Counterweight
360 Degree Rating On Fully Extended Outriggers

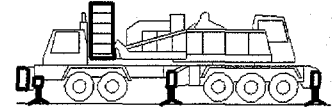

50 Ft. JIB

Jib Oper. Rad. Feet	5 Degree Offset			15 Degree Offset			25 Degree Offset			Jib Oper. Rad. Feet
	Boom Ang. Deg.	Jib Point Elev. Feet	Jib Capacity Pounds	Boom Ang. Deg.	Jib Point Elev. Feet	Jib Capacity Pounds	Boom Ang. Deg.	Jib Point Elev. Feet	Jib Capacity Pounds	
100 Ft. BOOM										
35	80.0	157.9	42,900*							35
40	78.0	156.8	41,800*							40
45	76.1	155.5	40,700*	79.4	154.2	37,100*				45
50	74.1	154.0	39,600*	77.4	152.7	36,200*	80.8	150.0	32,100*	50
55	72.1	152.3	38,700*	75.4	151.0	35,500*	78.8	148.2	30,500*	55
60	70.1	150.4	37,800*	73.4	149.1	34,800*	76.7	146.3	29,000*	60
65	68.1	148.3	36,900*	71.3	147.0	34,100*	74.6	144.1	27,700*	65
70	66.0	145.9	36,100*	69.2	144.6	33,500*	72.4	141.7	26,500*	70
75	63.9	143.4	35,400*	67.1	142.1	32,900*	70.3	139.1	25,500*	75
80	61.7	140.6	34,600*	64.9	139.2	32,300*	68.0	136.2	24,500*	80
85	59.5	137.6	34,000*	62.7	136.2	31,200*	65.8	133.1	23,600*	85
90	57.3	134.3	33,300*	60.4	132.8	29,800*	63.4	129.6	22,800*	90
100	52.5	126.7	32,200*	55.6	125.2	27,400*	58.5	121.8	21,400*	100
110	47.5	117.8	30,900*	50.5	116.1	25,400*	53.2	112.4	20,200*	110
120	41.9	107.0	27,000	44.8	105.1	23,700*	47.3	101.0	19,200*	120
130	35.7	93.6	23,600	38.4	91.5	22,300*	40.6	86.6	18,400*	130
140	28.1	76.3	20,700	30.6	73.6	21,000	32.2	67.3	17,900*	140
150	17.6	50.2	18,100	19.3	45.6	18,300				150



Liftcrane Jib Capacities

Meets
ANSI B30.5
Requirements

Jib No. 134 With 12 Ft. 6 in. Strut On
Boom No. 78T With Heavy Lift Top
95,400 Lb. Crane Counterweight
25,000 Lb. Front Bumper Counterweight
360 Degree Rating On Fully Extended Outriggers

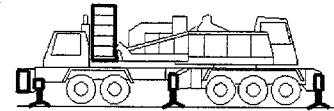

50 Ft. JIB

Jib Oper. Rad. Feet	5 Degree Offset			15 Degree Offset			25 Degree Offset			Jib Oper. Rad. Feet
	Boom Ang. Deg.	Jib Point Elev. Feet	Jib Capacity Pounds	Boom Ang. Deg.	Jib Point Elev. Feet	Jib Capacity Pounds	Boom Ang. Deg.	Jib Point Elev. Feet	Jib Capacity Pounds	
110 Ft. BOOM										
35	80.6	168.2	43,300*							35
40	78.8	167.1	42,200*							40
45	77.0	165.8	41,200*	80.1	164.6	37,400*				45
50	75.1	164.4	40,200*	78.2	163.2	36,600*				50
55	73.3	162.8	39,200*	76.3	161.6	35,800*	79.5	158.7	31,100*	55
60	71.4	161.1	38,400*	74.4	159.8	35,100*	77.6	156.9	29,600*	60
65	69.5	159.1	37,500*	72.5	157.8	34,500*	75.6	154.9	28,400*	65
70	67.6	157.0	36,700*	70.6	155.6	33,900*	73.7	152.7	27,200*	70
75	65.6	154.6	36,000*	68.6	153.3	33,300*	71.6	150.3	26,100*	75
80	63.6	152.1	35,300*	66.6	150.7	32,800*	69.6	147.6	25,200*	80
85	61.6	149.3	34,600*	64.6	147.9	32,200*	67.5	144.7	24,300*	85
90	59.5	146.2	34,000*	62.5	144.8	31,100*	65.4	141.6	23,500*	90
100	55.3	139.4	32,800*	58.2	137.9	28,600*	60.9	134.5	22,000*	100
110	50.7	131.4	30,700	53.6	129.7	26,500*	56.2	126.1	20,800*	110
120	45.9	121.9	26,700	48.6	120.1	24,800*	51.1	116.2	19,800*	120
130	40.5	110.5	23,300	43.2	108.6	23,300*	45.4	104.2	18,900*	130
140	34.5	96.6	20,400	37.0	94.3	20,800	38.9	89.2	18,300*	140
150	27.2	78.6	17,900	29.5	75.7	18,200	30.7	69.0	17,900*	150
160	17.0	51.5	15,700	18.5	46.6	15,800				160



Liftcrane Jib Capacities

Meets
ANSI B30.5
Requirements

Jib No. 134 With 12 Ft. 6 in. Strut On
Boom No. 78T With Heavy Lift Top
95,400 Lb. Crane Counterweight
25,000 Lb. Front Bumper Counterweight
360 Degree Rating On Fully Extended Outriggers

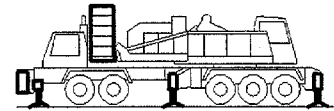

50 Ft. JIB

Jib Oper. Rad. Feet	5 Degree Offset			15 Degree Offset			25 Degree Offset			Jib Oper. Rad. Feet
	Boom Ang. Deg.	Jib Point Elev. Feet	Jib Capacity Pounds	Boom Ang. Deg.	Jib Point Elev. Feet	Jib Capacity Pounds	Boom Ang. Deg.	Jib Point Elev. Feet	Jib Capacity Pounds	
120 Ft. BOOM										
40	79.4	177.3	42,600*							40
45	77.7	176.2	41,600*	80.7	174.9	37,600*				45
50	76.0	174.8	40,600*	78.9	173.5	36,800*				50
55	74.3	173.4	39,700*	77.2	172.0	36,100*	80.2	169.2	31,600*	55
60	72.5	171.7	38,900*	75.4	170.4	35,500*	78.4	167.5	30,200*	60
65	70.8	169.9	38,100*	73.6	168.5	34,800*	76.5	165.6	28,900*	65
70	69.0	167.9	37,300*	71.8	166.5	34,300*	74.7	163.5	27,800*	70
75	67.1	165.7	36,600*	70.0	164.3	33,700*	72.8	161.3	26,700*	75
80	65.3	163.3	35,900*	68.1	161.9	33,200*	70.9	158.8	25,800*	80
85	63.4	160.7	35,200*	66.2	159.3	32,600*	69.0	156.2	24,900*	85
90	61.5	157.9	34,600*	64.3	156.5	32,200*	67.0	153.3	24,100*	90
100	57.6	151.6	33,400*	60.3	150.1	29,800*	63.0	146.8	22,600*	100
110	53.5	144.3	30,600	56.2	142.7	27,700*	58.7	139.2	21,400*	110
120	49.1	135.8	26,600	51.7	134.1	25,800*	54.1	130.3	20,400*	120
130	44.4	125.8	23,200	47.0	124.0	23,700	49.2	119.9	19,500*	130
140	39.2	114.0	20,300	41.7	111.9	20,800	43.7	107.3	18,700*	140
150	33.4	99.5	17,900	35.7	97.1	18,200	37.4	91.6	18,200*	150
160	26.3	80.8	15,700	28.4	77.7	15,900	29.5	70.6	16,000	160
170	16.4	52.8	13,700	17.7	47.6	13,800				170



777T

Liftcrane Jib Capacities

Meets
ANSI B30.5
Requirements

Jib No. 134 With 12 Ft. 6 in. Strut On
Boom No. 78T With Heavy Lift Top
95,400 Lb. Crane Counterweight
25,000 Lb. Front Bumper Counterweight
360 Degree Rating On Fully Extended Outriggers

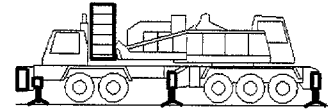

50 Ft. JIB

Jib Oper. Rad. Feet	5 Degree Offset			15 Degree Offset			25 Degree Offset			Jib Oper. Rad. Feet
	Boom Ang. Deg.	Jib Point Elev. Feet	Jib Capacity Pounds	Boom Ang. Deg.	Jib Point Elev. Feet	Jib Capacity Pounds	Boom Ang. Deg.	Jib Point Elev. Feet	Jib Capacity Pounds	
130 Ft. BOOM										
40	80.0	187.5	43,000*							40
45	78.4	186.4	42,000*							45
50	76.8	185.2	41,100*	79.6	183.9	37,100*				50
55	75.2	183.8	40,200*	77.9	182.5	36,400*	80.7	179.5	32,000*	55
60	73.5	182.2	39,400*	76.2	180.9	35,800*	79.1	177.9	30,700*	60
65	71.9	180.5	38,600*	74.6	179.2	35,200*	77.3	176.2	29,500*	65
70	70.2	178.7	37,800*	72.9	177.3	34,600*	75.6	174.3	28,300*	70
75	68.5	176.6	37,100*	71.2	175.2	34,000*	73.9	172.2	27,300*	75
80	66.8	174.4	36,400*	69.4	173.0	33,500*	72.1	169.9	26,400*	80
85	65.0	172.0	35,800*	67.7	170.5	33,000*	70.3	167.4	25,500*	85
90	63.2	169.4	35,100*	65.9	167.9	32,600*	68.5	164.7	24,700*	90
100	59.6	163.6	34,000*	62.2	162.1	30,900*	64.7	158.7	23,200*	100
110	55.8	156.9	30,200	58.4	155.3	28,700*	60.8	151.8	22,000*	110
120	51.8	149.1	26,100	54.4	147.4	26,800	56.7	143.7	20,900*	120
130	47.6	140.1	22,800	50.1	138.4	23,400	52.3	134.4	20,000*	130
140	43.1	129.7	19,900	45.5	127.7	20,400	47.5	123.4	19,200*	140
150	38.0	117.3	17,400	40.4	115.2	17,800	42.2	110.3	18,200	150
160	32.4	102.3	15,300	34.5	99.8	15,600	36.0	94.0	15,800	160
170	25.5	82.9	13,400	27.4	79.7	13,600	28.3	72.2	13,700	170
180	15.9	54.1	11,600	17.1	48.6	11,700				180



777T

Liftcrane Jib Capacities

Jib No. 134 With 12 Ft. 6 in. Strut On
Boom No. 78T With Heavy Lift Top
95,400 Lb. Crane Counterweight
25,000 Lb. Front Bumper Counterweight
360 Degree Rating On Fully Extended Outriggers

Meets
ANSI B30.5
Requirements

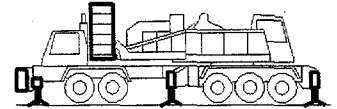

50 Ft. JIB

Jib Oper. Rad. Feet	5 Degree Offset			15 Degree Offset			25 Degree Offset			Jib Oper. Rad. Feet
	Boom Ang. Deg.	Jib Point Elev. Feet	Jib Capacity Pounds	Boom Ang. Deg.	Jib Point Elev. Feet	Jib Capacity Pounds	Boom Ang. Deg.	Jib Point Elev. Feet	Jib Capacity Pounds	
140 Ft. BOOM										
40	80.6	197.7	43,300*							40
45	79.0	196.7	42,400*							45
50	77.5	195.5	41,500*	80.1	194.2	37,300*				50
55	76.0	194.2	40,600*	78.6	192.8	36,700*				55
60	74.4	192.7	39,800*	77.0	191.4	36,100*	79.7	188.4	31,200*	60
65	72.8	191.1	39,000*	75.4	189.7	35,500*	78.1	186.7	30,000*	65
70	71.3	189.4	38,300*	73.8	188.0	34,900*	76.4	184.9	28,900*	70
75	69.7	187.4	37,600*	72.2	186.0	34,400*	74.8	182.9	27,800*	75
80	68.0	185.3	36,900*	70.6	183.9	33,900*	73.1	180.8	26,900*	80
85	66.4	183.1	36,300*	68.9	181.6	33,400*	71.5	178.5	26,000*	85
90	64.8	180.7	35,700*	67.3	179.2	32,900*	69.8	176.0	25,200*	90
100	61.4	175.2	34,500*	63.8	173.7	32,000*	66.3	170.4	23,800*	100
110	57.8	169.0	29,800	60.3	167.4	29,800*	62.6	164.0	22,500*	110
120	54.2	161.9	25,700	56.6	160.2	26,500	58.9	156.6	21,400*	120
130	50.3	153.7	22,400	52.7	152.0	23,000	54.9	148.1	20,500*	130
140	46.2	144.3	19,500	48.6	142.5	20,000	50.6	138.3	19,700*	140
150	41.8	133.4	17,000	44.1	131.4	17,500	46.0	126.9	17,900	150
160	37.0	120.6	14,900	39.1	118.3	15,300	40.8	113.2	15,600	160
170	31.4	105.0	13,000	33.5	102.3	13,300	34.8	96.3	13,500	170
180	24.8	85.0	11,300	26.6	81.7	11,500				180
190	15.4	55.3	9,700	16.5	49.6	9,800				190



777T

Liftcrane Jib Capacities

Jib No. 134 With 12 Ft. 6 in. Strut On
Boom No. 78T With Heavy Lift Top
95,400 Lb. Crane Counterweight
25,000 Lb. Front Bumper Counterweight
360 Degree Rating On Fully Extended Outriggers

Meets
ANSI B30.5
Requirements

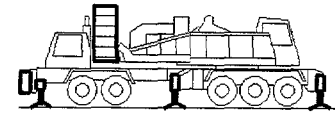

50 Ft. JIB

Jib Oper. Rad. Feet	5 Degree Offset			15 Degree Offset			25 Degree Offset			Jib Oper. Rad. Feet
	Boom Ang. Deg.	Jib Point Elev. Feet	Jib Capacity Pounds	Boom Ang. Deg.	Jib Point Elev. Feet	Jib Capacity Pounds	Boom Ang. Deg.	Jib Point Elev. Feet	Jib Capacity Pounds	
150 Ft. BOOM										
40	81.0	207.9	43,600*							40
45	79.6	206.9	42,700*							45
50	78.1	205.8	41,800*	80.6	204.4	37,600*				50
55	76.7	204.6	41,000*	79.1	203.2	36,900*				55
60	75.2	203.2	40,200*	77.7	201.8	36,300*	80.2	198.8	31,600*	60
65	73.7	201.6	39,500*	76.2	200.2	35,700*	78.7	197.2	30,400*	65
70	72.2	200.0	38,700*	74.7	198.6	35,200*	77.2	195.5	29,300*	70
75	70.7	198.2	38,000*	73.1	196.7	34,700*	75.6	193.6	28,300*	75
80	69.2	196.2	37,400*	71.6	194.8	34,200*	74.0	191.6	27,400*	80
85	67.7	194.1	36,800*	70.1	192.6	33,700*	72.5	189.4	26,500*	85
90	66.1	191.8	36,200*	68.5	190.3	33,200*	70.9	187.1	25,700*	90
100	62.9	186.7	34,100	65.3	185.2	32,400*	67.6	181.9	24,300*	100
110	59.6	180.9	29,200	62.0	179.3	28,600*	64.2	175.9	23,000*	110
120	56.2	174.3	25,100	58.5	172.7	25,500*	60.7	169.1	22,000*	120
130	52.7	166.7	21,700	55.0	165.0	22,400	57.1	161.3	21,000*	130
140	49.0	158.2	18,800	51.2	156.4	19,500	53.2	152.4	20,000	140
150	45.0	148.4	16,400	47.2	146.4	16,900	49.0	142.1	17,400	150
160	40.7	137.0	14,200	42.8	134.9	14,700	44.5	130.2	15,100	160
170	36.0	123.7	12,400	38.0	121.4	12,700	39.5	116.1	13,000	170
180	30.6	107.6	10,700	32.5	104.9	10,900	33.7	98.6	11,100	180
190	24.1	87.0	9,100	25.8	83.5	9,300				190
200	15.0	56.5	7,700							200



Liftcrane Jib Capacities

Meets
ANSI B30.5
Requirements

Jib No. 134 With 12 Ft. 6 in. Strut On
Boom No. 78T With Heavy Lift Top
95,400 Lb. Crane Counterweight
25,000 Lb. Front Bumper Counterweight
360 Degree Rating On Fully Extended Outriggers

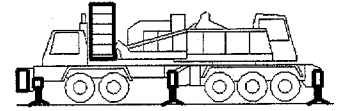

50 Ft. JIB

Jib Oper. Rad. Feet	5 Degree Offset			15 Degree Offset			25 Degree Offset			Jib Oper. Rad. Feet
	Boom Ang. Deg.	Jib Point Elev. Feet	Jib Capacity Pounds	Boom Ang. Deg.	Jib Point Elev. Feet	Jib Capacity Pounds	Boom Ang. Deg.	Jib Point Elev. Feet	Jib Capacity Pounds	
160 Ft. BOOM										
45	80.1	217.1	43,000*							45
50	78.7	216.1	42,200*							50
55	77.3	214.9	41,400*	79.7	213.5	37,100*				55
60	75.9	213.6	40,600*	78.3	212.2	36,500*	80.7	209.1	32,000*	60
65	74.5	212.1	39,900*	76.9	210.7	36,000*	79.3	207.6	30,800*	65
70	73.1	210.5	39,100*	75.4	209.1	35,500*	77.8	206.0	29,800*	70
75	71.7	208.8	38,500*	74.0	207.4	34,900*	76.3	204.2	28,800*	75
80	70.2	206.9	37,800*	72.5	205.5	34,500*	74.9	202.3	27,900*	80
85	68.8	204.9	37,200*	71.1	203.5	34,000*	73.4	200.3	27,000*	85
90	67.3	202.8	36,600*	69.6	201.3	33,500*	71.9	198.1	26,200*	90
100	64.3	198.0	32,300*	66.6	196.5	30,100*	68.8	193.2	24,800*	100
110	61.2	192.6	28,100*	63.5	191.0	26,500*	65.6	187.6	23,500*	110
120	58.1	186.4	24,700	60.3	184.8	23,600*	62.4	181.2	22,400*	120
130	54.8	179.4	21,300	56.9	177.7	21,000*	59.0	174.0	20,300*	130
140	51.3	171.5	18,400	53.5	169.7	18,800*	55.4	165.8	18,200*	140
150	47.7	162.5	16,000	49.8	160.6	16,500	51.6	156.5	16,500*	150
160	43.8	152.3	13,800	45.9	150.3	14,300	47.6	145.9	14,700	160
170	39.7	140.5	11,900	41.6	138.4	12,400	43.2	133.5	12,700	170
180	35.1	126.8	10,300	37.0	124.3	10,600	38.3	118.8	10,900	180
190	29.8	110.2	8,800	31.6	107.3	9,000	32.7	100.8	9,200	190
200	23.5	89.0	7,400	25.0	85.4	7,600				200
210	14.6	57.7	6,100							210



777T

Liftcrane Jib Capacities

Meets
ANSI B30.5
Requirements

Jib No. 134 With 12 Ft. 6 in. Strut On
Boom No. 78T With Heavy Lift Top
95,400 Lb. Crane Counterweight
25,000 Lb. Front Bumper Counterweight
360 Degree Rating On Fully Extended Outriggers

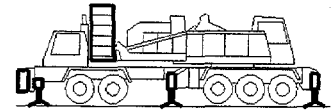

50 Ft. JIB

Jib Oper. Rad. Feet	5 Degree Offset			15 Degree Offset			25 Degree Offset			Jib Oper. Rad. Feet
	Boom Ang. Deg.	Jib Point Elev. Feet	Jib Capacity Pounds	Boom Ang. Deg.	Jib Point Elev. Feet	Jib Capacity Pounds	Boom Ang. Deg.	Jib Point Elev. Feet	Jib Capacity Pounds	
170 Ft. BOOM										
45	80.5	227.3	43,300*							45
50	79.2	226.3	42,500*							50
55	77.9	225.2	41,700*	80.2	223.8	37,300*				55
60	76.6	223.9	40,900*	78.8	222.5	36,800*				60
65	75.2	222.5	40,200*	77.5	221.1	36,200*	79.8	218.0	31,200*	65
70	73.9	221.0	39,500*	76.1	219.6	35,700*	78.4	216.5	30,200*	70
75	72.5	219.4	38,800*	74.7	218.0	35,200*	77.0	214.8	29,200*	75
80	71.2	217.6	38,200*	73.4	216.2	34,100*	75.6	213.0	28,300*	80
85	69.8	215.7	37,600*	72.0	214.3	32,500*	74.2	211.0	27,500*	85
90	68.4	213.7	35,400*	70.6	212.2	31,100*	72.8	209.0	26,700*	90
100	65.6	209.2	30,400*	67.7	207.6	28,400*	69.9	204.3	25,200*	100
110	62.7	204.0	26,500*	64.8	202.5	24,900*	66.9	199.0	23,500*	110
120	59.7	198.2	23,300*	61.8	196.6	22,100*	63.8	193.1	21,100*	120
130	56.6	191.7	20,600*	58.7	190.0	19,600*	60.7	186.4	18,800*	130
140	53.4	184.3	18,200	55.5	182.6	17,400*	57.4	178.8	16,800*	140
150	50.0	176.1	15,700	52.1	174.2	15,600*	53.9	170.2	15,100*	150
160	46.5	166.7	13,600	48.5	164.8	14,100	50.2	160.5	13,700*	160
170	42.8	156.1	11,700	44.7	154.1	12,200	46.3	149.5	12,300*	170
180	38.7	144.0	10,100	40.6	141.7	10,500	42.0	136.7	10,800	180
190	34.2	129.8	8,600	36.0	127.2	8,900	37.3	121.5	9,100	190
200	29.1	112.7	7,200	30.8	109.7	7,500	31.7	103.0	7,600	200
210	22.9	90.9	6,000	24.4	87.2	6,200				210
220	14.2	58.8	4,800							220



777T

Liftcrane Jib Capacities

Jib No. 134 With 12 Ft. 6 in. Strut On
 Boom No. 78T With Heavy Lift Top
 95,400 Lb. Crane Counterweight
 25,000 Lb. Front Bumper Counterweight
 360 Degree Rating On Fully Extended Outriggers

Meets
 ANSI B30.5
 Requirements

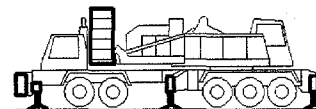

50 Ft. JIB

Jib Oper. Rad. Feet	5 Degree Offset			15 Degree Offset			25 Degree Offset			Jib Oper. Rad. Feet
	Boom Ang. Deg.	Jib Point Elev. Feet	Jib Capacity Pounds	Boom Ang. Deg.	Jib Point Elev. Feet	Jib Capacity Pounds	Boom Ang. Deg.	Jib Point Elev. Feet	Jib Capacity Pounds	
180 Ft. BOOM										
45	80.9	237.5	43,100*							45
50	79.7	236.5	42,500*							50
55	78.4	235.4	41,900*	80.6	234.0	37,500*				55
60	77.2	234.2	41,300*	79.3	232.8	37,000*				60
65	75.9	232.9	40,600*	78.0	231.5	36,400*	80.2	228.3	31,600*	65
70	74.6	231.5	39,900*	76.7	230.0	35,900*	78.9	226.9	30,600*	70
75	73.3	229.9	39,300*	75.4	228.5	35,500*	77.6	225.3	29,600*	75
80	72.0	228.2	38,600*	74.1	226.8	35,000*	76.3	223.6	28,700*	80
85	70.7	226.4	38,000*	72.8	225.0	34,500*	74.9	221.7	27,900*	85
90	69.4	224.5	36,100*	71.5	223.0	32,800*	73.6	219.7	27,100*	90
100	66.7	220.2	31,100*	68.8	218.7	28,800*	70.8	215.4	25,700*	100
110	63.9	215.3	27,100*	66.0	213.8	25,300*	68.0	210.4	23,900*	110
120	61.1	209.9	23,800*	63.2	208.3	22,400*	65.1	204.8	21,200*	120
130	58.2	203.7	20,600	60.2	202.1	19,800*	62.2	198.4	19,000*	130
140	55.2	196.8	17,700	57.2	195.1	17,700*	59.1	191.4	17,000*	140
150	52.1	189.1	15,300	54.1	187.4	15,900	55.9	183.4	15,300*	150
160	48.9	180.5	13,100	50.8	178.7	13,700	52.5	174.5	13,800*	160
170	45.4	170.8	11,300	47.3	168.8	11,800	48.9	164.4	12,200	170
180	41.8	159.9	9,600	43.6	157.7	10,000	45.1	153.0	10,400	180
190	37.8	147.3	8,100	39.6	145.0	8,500	40.9	139.8	8,800	190
200	33.4	132.7	6,800	35.1	130.1	7,100	36.3	124.2	7,300	200
210	28.4	115.1	5,600	30.0	112.1	5,800	30.8	105.1	5,900	210
220	22.4	92.8	4,400	23.7	88.9	4,600				220
230	13.9	59.9	3,400							230



777T

Liftcrane Jib Capacities

Meets
 ANSI B30.5
 Requirements

Jib No. 134 With 12 Ft. 6 in. Strut On
 Boom No. 78T With Heavy Lift Top
 95,400 Lb. Crane Counterweight
 25,000 Lb. Front Bumper Counterweight
 360 Degree Rating On Fully Extended Outriggers

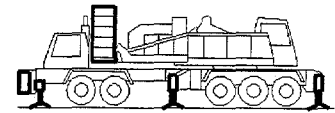

50 Ft. JIB

Jib Oper. Rad. Feet	5 Degree Offset			15 Degree Offset			25 Degree Offset			Jib Oper. Rad. Feet
	Boom Ang. Deg.	Jib Point Elev. Feet	Jib Capacity Pounds	Boom Ang. Deg.	Jib Point Elev. Feet	Jib Capacity Pounds	Boom Ang. Deg.	Jib Point Elev. Feet	Jib Capacity Pounds	
190 Ft. BOOM										
50	80.1	246.7	42,300*							50
55	78.9	245.7	41,700*	81.0	244.2	37,700*				55
60	77.7	244.5	41,100*	79.8	243.1	37,200*				60
65	76.5	243.3	40,600*	78.5	241.8	36,700*	80.7	238.7	32,000*	65
70	75.3	241.9	40,000*	77.3	240.4	36,200*	79.4	237.3	31,000*	70
75	74.0	240.4	39,500*	76.1	239.0	35,700*	78.1	235.7	30,000*	75
80	72.8	238.8	39,000*	74.8	237.3	35,200*	76.9	234.1	29,100*	80
85	71.5	237.1	38,400*	73.6	235.6	34,800*	75.6	232.3	28,300*	85
90	70.3	235.2	36,900*	72.3	233.7	33,500*	74.3	230.5	27,500*	90
100	67.7	231.2	31,900*	69.7	229.6	29,200*	71.7	226.3	26,100*	100
110	65.1	226.5	27,700	67.1	225.0	25,800*	69.0	221.6	24,200*	110
120	62.4	221.3	23,600	64.4	219.7	22,700*	66.3	216.2	21,600*	120
130	59.7	215.5	20,200	61.6	213.9	20,200*	63.5	210.3	19,200*	130
140	56.9	209.1	17,300	58.8	207.4	17,900*	60.6	203.7	17,300*	140
150	54.0	201.9	14,800	55.9	200.1	15,500	57.6	196.2	15,500*	150
160	50.9	193.8	12,700	52.8	192.0	13,300	54.5	188.0	13,900	160
170	47.8	184.9	10,800	49.6	183.0	11,400	51.2	178.7	11,900	170
180	44.4	174.8	9,200	46.2	172.8	9,600	47.7	168.3	10,000	180
190	40.8	163.5	7,700	42.6	161.3	8,100	44.0	156.4	8,400	190
200	36.9	150.6	6,300	38.6	148.2	6,700	39.9	142.8	7,000	200
210	32.7	135.5	5,100	34.3	132.8	5,400	35.3	126.8	5,600	210
220	27.8	117.5	4,000	29.3	114.3	4,200	30.0	107.2	4,400	220
230	21.9	94.7	3,000	23.1	90.6	3,100				230
240	13.6	61.0	2,000							240

Liftcrane Jib Capacities

Meets
ANSI B30.5
Requirements

Jib No. 134 With 12 Ft. 6 in. Strut On
Boom No. 78T With Heavy Lift Top
95,400 Lb. Crane Counterweight
25,000 Lb. Front Bumper Counterweight
360 Degree Rating On Fully Extended Outriggers

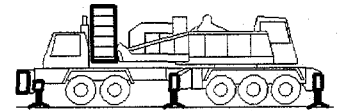

50 Ft. JIB

Jib Oper. Rad. Feet	5 Degree Offset			15 Degree Offset			25 Degree Offset			Jib Oper. Rad. Feet
	Boom Ang. Deg.	Jib Point Elev. Feet	Jib Capacity Pounds	Boom Ang. Deg.	Jib Point Elev. Feet	Jib Capacity Pounds	Boom Ang. Deg.	Jib Point Elev. Feet	Jib Capacity Pounds	
200 Ft. BOOM										
50	80.5	256.9	42,000 *							50
55	79.4	255.9	41,500 *							55
60	78.2	254.8	40,900 *	80.2	253.4	37,400*				60
65	77.0	253.6	40,400 *	79.0	252.1	36,900*	81.0	249.0	32,300*	65
70	75.9	252.3	39,900 *	77.8	250.8	36,400*	79.8	247.6	31,300*	70
75	74.7	250.9	39,400 *	76.6	249.4	35,900*	78.6	246.2	30,400*	75
80	73.5	249.3	38,900 *	75.4	247.8	35,500*	77.4	244.6	29,500*	80
85	72.3	247.7	38,500 *	74.2	246.2	35,000*	76.2	242.9	28,700*	85
90	71.1	245.9	36,200 *	73.0	244.4	33,900*	75.0	241.1	27,900*	90
100	68.6	242.0	31,300 *	70.6	240.5	29,700*	72.5	237.1	26,500*	100
110	66.2	237.6	27,200	68.1	236.1	26,100*	69.9	232.6	24,400*	110
120	63.6	232.7	23,100	65.5	231.1	23,000*	67.4	227.6	21,700*	120
130	61.0	227.2	19,700	62.9	225.5	20,300*	64.7	222.0	19,500*	130
140	58.4	221.1	16,800	60.2	219.4	17,700	62.0	215.7	17,000*	140
150	55.6	214.3	14,300	57.5	212.5	15,100	59.2	208.7	14,800*	150
160	52.8	206.8	12,200	54.6	205.0	12,900	56.2	201.0	12,900*	160
170	49.8	198.4	10,300	51.6	196.5	10,900	53.2	192.4	11,100*	170
180	46.7	189.1	8,700	48.5	187.1	9,200	50.0	182.8	9,500*	180
190	43.4	178.7	7,200	45.1	176.6	7,600	46.6	172.0	8,000	190
200	39.9	167.1	5,900	41.6	164.8	6,200	42.9	159.8	6,600	200
210	36.2	153.7	4,600	37.8	151.3	5,000	38.9	145.8	5,200	210
220	32.0	138.3	3,500	33.5	135.5	3,800	34.5	129.3	4,000	220
230	27.2	119.8	2,500	28.6	116.6	2,700	29.3	109.2	2,800	230



Liftcrane Jib Capacities

Meets
 ANSI B30.5
 Requirements

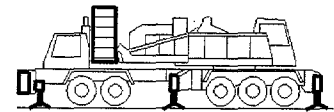

Jib No. 134 With 12 Ft. 6 in. Strut On
 Boom No. 78T With Heavy Lift Top
 95,400 Lb. Crane Counterweight
 25,000 Lb. Front Bumper Counterweight
 360 Degree Rating On Fully Extended Outriggers

50 Ft. JIB

Jib Oper. Rad. Feet	5 Degree Offset			15 Degree Offset			25 Degree Offset			Jib Oper. Rad. Feet
	Boom Ang. Deg.	Jib Point Elev. Feet	Jib Capacity Pounds	Boom Ang. Deg.	Jib Point Elev. Feet	Jib Capacity Pounds	Boom Ang. Deg.	Jib Point Elev. Feet	Jib Capacity Pounds	
210 Ft. BOOM										
50	80.9	267.1	41,700*							50
55	79.8	266.1	41,200*							55
60	78.7	265.0	40,700*	80.6	263.6	37,400*				60
65	77.5	263.9	40,200*	79.4	262.4	36,700*				65
70	76.4	262.6	39,700*	78.3	261.2	35,100*	80.3	257.9	28,500*	70
75	75.3	261.3	39,200*	77.2	259.8	33,600*	79.1	256.5	27,600*	75
80	74.1	259.8	38,800*	76.0	258.3	32,200*	77.9	255.0	26,700*	80
85	73.0	258.2	35,800*	74.9	256.7	30,900*	76.8	253.4	25,900*	85
90	71.8	256.5	33,000*	73.7	255.0	29,600*	75.6	251.7	25,100*	90
100	69.5	252.8	28,300*	71.4	251.3	25,900*	73.2	247.9	23,600*	100
110	67.1	248.6	24,500*	69.0	247.0	22,600*	70.8	243.6	21,100*	110
120	64.7	243.9	21,400*	66.5	242.3	19,800*	68.3	238.8	18,600*	120
130	62.2	238.7	18,800*	64.1	237.0	17,400*	65.8	233.5	16,500*	130
140	59.7	232.9	16,400*	61.5	231.2	15,400*	63.2	227.5	14,600*	140
150	57.1	226.4	14,000	58.9	224.7	13,600*	60.5	221.0	13,000*	150
160	54.4	219.4	11,900	56.2	217.6	12,000*	57.8	213.7	11,500*	160
170	51.7	211.5	10,000	53.4	209.7	10,600	54.9	205.6	10,200*	170
180	48.8	202.9	8,300	50.5	201.0	8,900	52.0	196.7	9,000*	180
190	45.7	193.3	6,800	47.4	191.2	7,300	48.8	186.8	7,800	190
200	42.5	182.6	5,500	44.2	180.4	5,900	45.5	175.6	6,300	200
210	39.1	170.5	4,300	40.7	168.2	4,700	41.9	163.1	5,000	210
220	35.4	156.9	3,200	36.9	154.3	3,500	38.0	148.6	3,800	220
230	31.3	141.0	2,200	32.8	138.2	2,500	33.7	131.8	2,600	230



Liftcrane Jib Capacities

Meets
 ANSI B30.5
 Requirements

Jib No. 134 With 12 Ft. 6 in. Strut On
 Boom No. 78T With Heavy Lift Top
 95,400 Lb. Crane Counterweight
 25,000 Lb. Front Bumper Counterweight
 360 Degree Rating On Fully Extended Outriggers

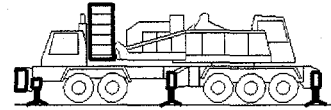

50 Ft. JIB

Jib Oper. Rad. Feet	5 Degree Offset			15 Degree Offset			25 Degree Offset			Jib Oper. Rad. Feet
	Boom Ang. Deg.	Jib Point Elev. Feet	Jib Capacity Pounds	Boom Ang. Deg.	Jib Point Elev. Feet	Jib Capacity Pounds	Boom Ang. Deg.	Jib Point Elev. Feet	Jib Capacity Pounds	
220 Ft. BOOM										
55	80.2	276.3	40,800*							55
60	79.1	275.3	40,300*	80.9	273.8	37,600*				60
65	78.0	274.2	39,900*	79.8	272.7	37,100*				65
70	76.9	273.0	39,400*	78.8	271.5	36,600*	80.6	268.2	29,300*	70
75	75.8	271.6	39,000*	77.7	270.2	35,200*	79.5	266.9	28,500*	75
80	74.7	270.2	38,600*	76.6	268.7	33,900*	78.4	265.5	27,700*	80
85	73.6	268.7	36,700*	75.4	267.2	32,500*	77.3	263.9	27,000*	85
90	72.5	267.1	33,900*	74.3	265.6	30,300*	76.2	262.3	26,200*	90
100	70.3	263.5	29,100*	72.1	262.0	26,300*	73.9	258.6	24,200*	100
110	68.0	259.5	25,200*	69.8	257.9	23,000*	71.6	254.5	21,300*	110
120	65.7	255.0	21,900*	67.5	253.4	20,200*	69.2	249.9	18,900*	120
130	63.4	250.0	19,100	65.1	248.4	17,800*	66.8	244.8	16,800*	130
140	61.0	244.5	16,200	62.7	242.8	15,800*	64.3	239.2	14,900*	140
150	58.5	238.4	13,700	60.2	236.7	14,000*	61.8	233.0	13,200*	150
160	56.0	231.7	11,600	57.7	229.9	12,300	59.2	226.1	11,800*	160
170	53.3	224.3	9,700	55.0	222.5	10,400	56.5	218.5	10,500*	170
180	50.6	216.2	8,000	52.3	214.3	8,600	53.7	210.2	9,200	180
190	47.8	207.2	6,600	49.4	205.3	7,100	50.8	200.9	7,600	190
200	44.8	197.3	5,200	46.4	195.3	5,700	47.8	190.7	6,100	200
210	41.7	186.3	4,000	43.3	184.1	4,500	44.5	179.2	4,800	210
220	38.4	173.9	3,000	39.9	171.6	3,300	41.0	166.3	3,600	220
230	34.7	159.9	2,000	36.2	157.3	2,300	37.2	151.5	2,500	230



777T

Liftcrane Jib Capacities

Jib No. 134 With 12 Ft. 6 in. Strut On
 Boom No. 78T With Heavy Lift Top
 95,400 Lb. Crane Counterweight
 25,000 Lb. Front Bumper Counterweight
 360 Degree Rating On Fully Extended Outriggers

Meets
 ANSI B30.5
 Requirements

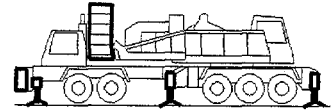

50 Ft. JIB

Jib Oper. Rad. Feet	5 Degree Offset			15 Degree Offset			25 Degree Offset			Jib Oper. Rad. Feet
	Boom Ang. Deg.	Jib Point Elev. Feet	Jib Capacity Pounds	Boom Ang. Deg.	Jib Point Elev. Feet	Jib Capacity Pounds	Boom Ang. Deg.	Jib Point Elev. Feet	Jib Capacity Pounds	
230 Ft. BOOM										
55	80.5	286.5	40,400*							55
60	79.5	285.5	40,000*							60
65	78.4	284.4	39,500*	80.2	282.9	37,200*				65
70	77.4	283.3	39,100*	79.2	281.8	36,900*	81.0	278.5	30,000*	70
75	76.3	282.0	38,700*	78.1	280.5	36,400*	79.9	277.2	29,300*	75
80	75.3	280.6	38,300*	77.0	279.1	35,200*	78.8	275.8	28,600*	80
85	74.2	279.2	37,300*	76.0	277.7	32,800*	77.8	274.4	27,900*	85
90	73.2	277.6	34,400*	74.9	276.1	30,600*	76.7	272.8	27,200*	90
100	71.0	274.2	29,600*	72.8	272.6	26,500*	74.5	269.3	24,300*	100
110	68.8	270.3	25,600*	70.6	268.8	23,200*	72.3	265.3	21,400*	110
120	66.6	266.0	22,000	68.3	264.4	20,400*	70.0	261.0	19,000*	120
130	64.4	261.3	18,600	66.1	259.6	18,000*	67.7	256.1	16,900*	130
140	62.1	256.0	15,700	63.8	254.3	15,900*	65.4	250.7	15,000*	140
150	59.7	250.2	13,300	61.4	248.5	14,000*	63.0	244.8	13,300*	150
160	57.3	243.8	11,100	59.0	242.1	11,900	60.5	238.3	11,800*	160
170	54.9	236.8	9,200	56.5	235.0	9,900	58.0	231.1	10,200*	170
180	52.3	229.2	7,600	53.9	227.3	8,200	55.3	223.2	8,500*	180
190	49.6	220.8	6,100	51.2	218.8	6,700	52.6	214.6	7,200	190
200	46.9	211.5	4,800	48.4	209.5	5,300	49.8	205.0	5,700	200
210	44.0	201.3	3,600	45.5	199.2	4,000	46.8	194.5	4,400	210
220	40.9	190.0	2,500	42.4	187.7	2,900	43.6	182.7	3,200	220
230							40.1	169.4	2,100	230



777T

Liftcrane Jib Capacities

Jib No. 134 With 12 Ft. 6 in. Strut On
Boom No. 78T With Heavy Lift Top
95,400 Lb. Crane Counterweight
25,000 Lb. Front Bumper Counterweight
360 Degree Rating On Fully Extended Outriggers

Meets
ANSI B30.5
Requirements

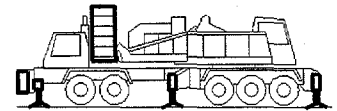

60 Ft. JIB

Jib Oper. Rad. Feet	5 Degree Offset			15 Degree Offset			25 Degree Offset			Jib Oper. Rad. Feet
	Boom Ang. Deg.	Jib Point Elev. Feet	Jib Capacity Pounds	Boom Ang. Deg.	Jib Point Elev. Feet	Jib Capacity Pounds	Boom Ang. Deg.	Jib Point Elev. Feet	Jib Capacity Pounds	
100 Ft. BOOM										
35	80.6	168.2	36,000*							35
40	78.8	167.1	35,100*							40
45	77.0	165.9	34,200*							45
50	75.2	164.5	33,400*	79.3	163.4	29,500*				50
55	73.3	162.9	32,600*	77.4	161.9	29,500*				55
60	71.5	161.1	31,900*	75.5	160.1	29,400*	79.4	157.1	26,400*	60
65	69.6	159.2	31,200*	73.6	158.2	28,800*	77.4	155.1	25,100*	65
70	67.6	157.0	30,500*	71.7	156.1	28,200*	75.5	153.0	24,000*	70
75	65.7	154.7	29,800*	69.7	153.7	27,600*	73.4	150.6	22,900*	75
80	63.7	152.1	29,100*	67.7	151.2	27,100*	71.4	148.0	21,900*	80
85	61.7	149.3	28,500*	65.7	148.4	26,600*	69.3	145.1	21,000*	85
90	59.6	146.3	27,900*	63.6	145.4	26,000*	67.2	142.0	20,200*	90
100	55.3	139.4	26,700*	59.3	138.6	24,700*	62.8	135.1	18,800*	100
110	50.8	131.4	25,700*	54.7	130.6	22,700*	58.1	126.8	17,600*	110
120	45.9	121.9	24,600*	49.8	121.1	21,100*	53.0	117.0	16,600*	120
130	40.6	110.6	22,600*	44.4	109.8	19,700*	47.4	105.2	15,800*	130
140	34.5	96.7	20,900*	38.3	95.8	18,500*	40.9	90.5	15,100*	140
150	27.3	78.7	18,700	31.0	77.7	17,500*	32.9	70.8	14,600*	150
160	17.1	51.7	16,400	20.6	50.3	16,700				160



777T

Liftcrane Jib Capacities

Jib No. 134 With 12 Ft. 6 in. Strut On
Boom No. 78T With Heavy Lift Top
95,400 Lb. Crane Counterweight
25,000 Lb. Front Bumper Counterweight
360 Degree Rating On Fully Extended Outriggers

Meets
ANSI B30.5
Requirements

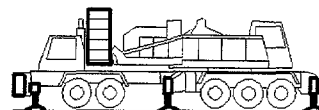

60 Ft. JIB

Jib Oper. Rad. Feet	5 Degree Offset			15 Degree Offset			25 Degree Offset			Jib Oper. Rad. Feet
	Boom Ang. Deg.	Jib Point Elev. Feet	Jib Capacity Pounds	Boom Ang. Deg.	Jib Point Elev. Feet	Jib Capacity Pounds	Boom Ang. Deg.	Jib Point Elev. Feet	Jib Capacity Pounds	
110 Ft. BOOM										
40	79.5	177.4	35,400*							40
45	77.8	176.2	34,600*							45
50	76.1	174.9	33,800*	79.9	173.8	29,500*				50
55	74.3	173.4	33,100*	78.2	172.3	29,500*				55
60	72.6	171.7	32,400*	76.4	170.7	29,500*	80.0	167.6	26,900*	60
65	70.8	169.9	31,700*	74.6	168.9	29,100*	78.2	165.8	25,600*	65
70	69.0	167.9	31,000*	72.8	166.9	28,500*	76.4	163.7	24,500*	70
75	67.2	165.7	30,400*	71.0	164.7	28,000*	74.5	161.5	23,400*	75
80	65.4	163.3	29,700*	69.1	162.4	27,400*	72.6	159.1	22,500*	80
85	63.5	160.8	29,100*	67.3	159.8	26,900*	70.7	156.5	21,600*	85
90	61.6	158.0	28,400*	65.3	157.0	26,500*	68.7	153.6	20,800*	90
100	57.7	151.7	27,300*	61.4	150.8	25,600*	64.7	147.2	19,400*	100
110	53.5	144.4	26,300*	57.2	143.5	23,800*	60.4	139.7	18,200*	110
120	49.2	135.9	25,400*	52.8	135.0	22,000*	55.9	131.0	17,200*	120
130	44.5	125.9	23,700	48.1	125.0	20,600*	51.0	120.7	16,300*	130
140	39.3	114.0	20,800	42.9	113.1	19,300*	45.5	108.3	15,600*	140
150	33.4	99.6	18,300	37.0	98.6	18,200*	39.3	92.9	15,000*	150
160	26.4	80.9	16,200	29.8	79.8	16,600	31.5	72.4	14,600*	160
170	16.5	53.0	14,200	19.7	51.4	14,400				170



Liftcrane Jib Capacities

Meets
ANSI B30.5
Requirements

Jib No. 134 With 12 Ft. 6 in. Strut On
Boom No. 78T With Heavy Lift Top
95,400 Lb. Crane Counterweight
25,000 Lb. Front Bumper Counterweight
360 Degree Rating On Fully Extended Outriggers

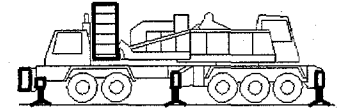

60 Ft. JIB

Jib Oper. Rad. Feet	5 Degree Offset			15 Degree Offset			25 Degree Offset			Jib Oper. Rad. Feet
	Boom Ang. Deg.	Jib Point Elev. Feet	Jib Capacity Pounds	Boom Ang. Deg.	Jib Point Elev. Feet	Jib Capacity Pounds	Boom Ang. Deg.	Jib Point Elev. Feet	Jib Capacity Pounds	
120 Ft. BOOM										
40	80.1	187.6	35,700*							40
45	78.5	186.5	34,900*							45
50	76.9	185.2	34,200*	80.5	184.1	29,500*				50
55	75.2	183.8	33,400*	78.8	182.7	29,500*				55
60	73.6	182.3	32,800*	77.2	181.2	29,500*	80.6	178.0	27,200*	60
65	71.9	180.6	32,100*	75.5	179.5	29,400*	78.9	176.3	26,100*	65
70	70.2	178.7	31,500*	73.8	177.6	28,800*	77.2	174.4	25,000*	70
75	68.5	176.6	30,900*	72.1	175.6	28,300*	75.5	172.3	23,900*	75
80	66.8	174.4	30,200*	70.4	173.4	27,800*	73.7	170.1	23,000*	80
85	65.1	172.0	29,600*	68.6	171.0	27,300*	71.9	167.6	22,100*	85
90	63.3	169.4	29,000*	66.8	168.4	26,800*	70.1	165.0	21,300*	90
100	59.7	163.6	27,900*	63.2	162.6	26,000*	66.3	159.1	19,900*	100
110	55.9	156.9	26,900*	59.4	155.9	24,800*	62.4	152.2	18,700*	110
120	51.9	149.1	26,000*	55.4	148.2	23,000*	58.3	144.3	17,700*	120
130	47.7	140.2	23,500	51.1	139.2	21,500*	53.9	135.0	16,800*	130
140	43.1	129.7	20,700	46.5	128.8	20,200*	49.2	124.2	16,000*	140
150	38.1	117.4	18,200	41.5	116.4	18,800	43.9	111.3	15,400*	150
160	32.4	102.3	16,100	35.7	101.3	16,500	37.8	95.3	14,900*	160
170	25.6	83.0	14,200	28.8	81.8	14,500	30.3	74.0	14,600*	170
180	16.0	54.2	12,400	19.0	52.5	12,600				180



777T

Liftcrane Jib Capacities

Meets
ANSI B30.5
Requirements

Jib No. 134 With 12 Ft. 6 in. Strut On
Boom No. 78T With Heavy Lift Top
95,400 Lb. Crane Counterweight
25,000 Lb. Front Bumper Counterweight
360 Degree Rating On Fully Extended Outriggers

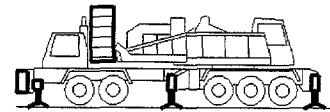

60 Ft. JIB

Jib Oper. Rad. Feet	5 Degree Offset			15 Degree Offset			25 Degree Offset			Jib Oper. Rad. Feet
	Boom Ang. Deg.	Jib Point Elev. Feet	Jib Capacity Pounds	Boom Ang. Deg.	Jib Point Elev. Feet	Jib Capacity Pounds	Boom Ang. Deg.	Jib Point Elev. Feet	Jib Capacity Pounds	
130 Ft. BOOM										
40	80.6	197.8	36,000*							40
45	79.1	196.7	35,200*							45
50	77.6	195.5	34,500*	81.0	194.4	29,500*				50
55	76.0	194.2	33,800*	79.4	193.1	29,500*				55
60	74.5	192.8	33,100*	77.9	191.6	29,500*				60
65	72.9	191.2	32,500*	76.3	190.0	29,500*	79.5	186.8	26,500*	65
70	71.3	189.4	31,900*	74.7	188.3	29,100*	77.9	185.0	25,400*	70
75	69.7	187.5	31,300*	73.1	186.4	28,600*	76.3	183.1	24,400*	75
80	68.1	185.4	30,700*	71.5	184.3	28,100*	74.6	180.9	23,500*	80
85	66.5	183.1	30,100*	69.8	182.1	27,600*	73.0	178.7	22,600*	85
90	64.8	180.7	29,500*	68.2	179.6	27,200*	71.3	176.2	21,800*	90
100	61.4	175.3	28,400*	64.8	174.2	26,300*	67.8	170.7	20,400*	100
110	57.9	169.1	27,400*	61.2	168.0	25,500*	64.2	164.3	19,200*	110
120	54.2	161.9	26,500	57.5	160.9	23,900*	60.4	157.0	18,200*	120
130	50.4	153.8	23,100	53.7	152.8	22,300*	56.4	148.6	17,300*	130
140	46.3	144.4	20,200	49.5	143.4	21,000	52.1	139.0	16,500*	140
150	41.9	133.5	17,800	45.1	132.5	18,400	47.5	127.6	15,800*	150
160	37.0	120.6	15,600	40.2	119.6	16,200	42.4	114.2	15,200*	160
170	31.5	105.0	13,700	34.6	103.9	14,200	36.5	97.6	14,400	170
180	24.9	85.1	12,000	27.9	83.8	12,400	29.1	75.6	12,500	180
190	15.5	55.4	10,500	18.3	53.5	10,700				190

Liftcrane Jib Capacities

Meets
ANSI B30.5
Requirements

Jib No. 134 With 12 Ft. 6 in. Strut On
Boom No. 78T With Heavy Lift Top
95,400 Lb. Crane Counterweight
25,000 Lb. Front Bumper Counterweight
360 Degree Rating On Fully Extended Outriggers

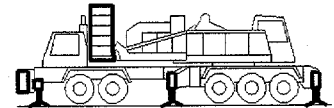

60 Ft. JIB

Jib Oper. Rad. Feet	5 Degree Offset			15 Degree Offset			25 Degree Offset			Jib Oper. Rad. Feet
	Boom Ang. Deg.	Jib Point Elev. Feet	Jib Capacity Pounds	Boom Ang. Deg.	Jib Point Elev. Feet	Jib Capacity Pounds	Boom Ang. Deg.	Jib Point Elev. Feet	Jib Capacity Pounds	
140 Ft. BOOM										
45	79.6	207.0	35,500*							45
50	78.2	205.8	34,800*							50
55	76.7	204.6	34,100*	80.0	203.4	29,500*				55
60	75.3	203.2	33,500*	78.5	202.0	29,500*				60
65	73.8	201.7	32,800*	77.0	200.5	29,500*	80.1	197.2	26,800*	65
70	72.3	200.0	32,200*	75.5	198.9	29,400*	78.6	195.5	25,900*	70
75	70.8	198.2	31,700*	74.0	197.1	28,900*	77.0	193.7	24,900*	75
80	69.2	196.2	31,100*	72.5	195.1	28,400*	75.5	191.7	23,900*	80
85	67.7	194.1	30,600*	70.9	193.0	28,000*	73.9	189.6	23,100*	85
90	66.2	191.8	30,000*	69.4	190.7	27,500*	72.3	187.2	22,300*	90
100	63.0	186.7	28,900*	66.2	185.7	26,700*	69.0	182.1	20,900*	100
110	59.7	180.9	27,900*	62.9	179.9	25,900*	65.7	176.2	19,700*	110
120	56.3	174.3	26,000	59.4	173.3	24,800*	62.2	169.4	18,600*	120
130	52.7	166.8	22,700	55.9	165.8	23,200*	58.5	161.7	17,700*	130
140	49.0	158.2	19,800	52.1	157.2	20,600	54.6	152.9	16,900*	140
150	45.0	148.4	17,400	48.1	147.4	18,000	50.5	142.8	16,200*	150
160	40.8	137.1	15,200	43.8	136.0	15,800	46.0	131.0	15,600*	160
170	36.0	123.8	13,300	39.0	122.7	13,800	41.0	117.0	14,200	170
180	30.7	107.7	11,700	33.6	106.5	12,100	35.3	99.8	12,300	180
190	24.2	87.1	10,200	27.0	85.7	10,500	28.1	77.1	10,600	190
200	15.1	56.6	8,700	17.7	54.5	8,900				200



777T

Liftcrane Jib Capacities

Meets
ANSI B30.5
Requirements

Jib No. 134 With 12 Ft. 6 in. Strut On
Boom No. 78T With Heavy Lift Top
95,400 Lb. Crane Counterweight
25,000 Lb. Front Bumper Counterweight
360 Degree Rating On Fully Extended Outriggers

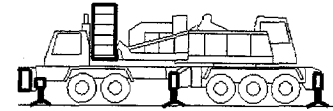

60 Ft. JIB

Jib Oper. Rad. Feet	5 Degree Offset			15 Degree Offset			25 Degree Offset			Jib Oper. Rad. Feet
	Boom Ang. Deg.	Jib Point Elev. Feet	Jib Capacity Pounds	Boom Ang. Deg.	Jib Point Elev. Feet	Jib Capacity Pounds	Boom Ang. Deg.	Jib Point Elev. Feet	Jib Capacity Pounds	
150 Ft. BOOM										
45	80.1	217.2	35,800*							45
50	78.8	216.1	35,100*							50
55	77.4	214.9	34,400*	80.5	213.7	29,500*				55
60	76.0	213.6	33,800*	79.1	212.4	29,500*				60
65	74.6	212.1	33,200*	77.7	211.0	29,500*	80.6	207.6	27,100*	65
70	73.1	210.6	32,600*	76.2	209.4	29,500*	79.1	206.0	26,200*	70
75	71.7	208.8	32,000*	74.8	207.7	29,000*	77.7	204.3	25,300*	75
80	70.3	207.0	31,500*	73.3	205.8	28,600*	76.2	202.4	24,400*	80
85	68.8	205.0	31,000*	71.9	203.8	28,100*	74.7	200.4	23,500*	85
90	67.4	202.8	30,400*	70.4	201.7	27,700*	73.2	198.2	22,800*	90
100	64.4	198.0	29,300*	67.4	196.9	26,900*	70.1	193.3	21,400*	100
110	61.3	192.6	28,300*	64.3	191.5	26,100*	67.0	187.8	20,100*	110
120	58.1	186.4	25,400	61.1	185.3	24,500*	63.7	181.5	19,100*	120
130	54.8	179.4	22,000	57.8	178.3	22,000*	60.3	174.3	18,200*	130
140	51.4	171.5	19,200	54.3	170.4	19,800*	56.8	166.2	17,300*	140
150	47.7	162.6	16,700	50.7	161.5	17,500	53.0	157.0	16,600*	150
160	43.9	152.3	14,600	46.8	151.3	15,200	49.0	146.5	15,800	160
170	39.7	140.6	12,700	42.6	139.5	13,300	44.6	134.2	13,700	170
180	35.1	126.8	11,000	37.9	125.7	11,500	39.8	119.8	11,800	180
190	29.9	110.2	9,500	32.7	109.0	9,900	34.2	102.0	10,100	190
200	23.6	89.1	8,100	26.2	87.6	8,500	27.1	78.6	8,500	200
210	14.7	57.8	6,900	17.1	55.5	7,000				210



Liftcrane Jib Capacities

Jib No. 134 With 12 Ft. 6 in. Strut On
Boom No. 78T With Heavy Lift Top
95,400 Lb. Crane Counterweight
25,000 Lb. Front Bumper Counterweight
360 Degree Rating On Fully Extended Outriggers

Meets
ANSI B30.5
Requirements

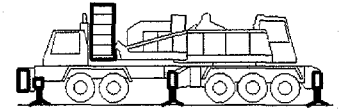

60 Ft. JIB

Jib Oper. Rad. Feet	5 Degree Offset			15 Degree Offset			25 Degree Offset			Jib Oper. Rad. Feet
	Boom Ang. Deg.	Jib Point Elev. Feet	Jib Capacity Pounds	Boom Ang. Deg.	Jib Point Elev. Feet	Jib Capacity Pounds	Boom Ang. Deg.	Jib Point Elev. Feet	Jib Capacity Pounds	
160 Ft. BOOM										
45	80.6	227.3	36,000*							45
50	79.3	226.3	35,300*							50
55	77.9	225.2	34,700*	80.9	223.9	29,500*				55
60	76.6	223.9	34,100*	79.6	222.7	29,500*				60
65	75.3	222.6	33,500*	78.2	221.3	29,500*	81.0	217.9	27,400*	65
70	73.9	221.1	32,900*	76.9	219.8	29,500*	79.7	216.4	26,500*	70
75	72.6	219.4	32,400*	75.5	218.2	29,100*	78.3	214.8	25,700*	75
80	71.2	217.7	31,800*	74.1	216.5	28,700*	76.9	213.0	24,800*	80
85	69.8	215.8	31,300*	72.8	214.6	28,300*	75.5	211.1	23,900*	85
90	68.4	213.7	30,800*	71.4	212.6	27,900*	74.0	209.0	23,200*	90
100	65.6	209.2	29,800*	68.5	208.0	27,200*	71.1	204.4	21,800*	100
110	62.7	204.1	27,500*	65.6	202.9	25,500*	68.2	199.2	20,600*	110
120	59.7	198.3	24,200*	62.6	197.1	22,700*	65.1	193.3	19,500*	120
130	56.6	191.7	21,400*	59.5	190.6	20,300*	61.9	186.6	18,600*	130
140	53.4	184.4	18,700	56.3	183.3	18,200*	58.7	179.1	17,400*	140
150	50.1	176.1	16,300	52.9	175.0	16,300*	55.2	170.6	15,800*	150
160	46.6	166.8	14,100	49.3	165.7	14,700*	51.5	161.0	14,300*	160
170	42.8	156.2	12,200	45.6	155.0	12,900	47.6	150.1	13,000*	170
180	38.7	144.0	10,600	41.5	142.9	11,100	43.4	137.4	11,500	180
190	34.3	129.8	9,100	36.9	128.6	9,600	38.6	122.5	9,900	190
200	29.2	112.7	7,700	31.8	111.4	8,100	33.1	104.2	8,300	200
210	23.0	91.0	6,500	25.5	89.5	6,800				210
220	14.3	58.9	5,300	16.6	56.5	5,500				220



777T

Liftcrane Jib Capacities

Jib No. 134 With 12 Ft. 6 in. Strut On
Boom No. 78T With Heavy Lift Top
95,400 Lb. Crane Counterweight
25,000 Lb. Front Bumper Counterweight
360 Degree Rating On Fully Extended Outriggers

Meets
ANSI B30.5
Requirements

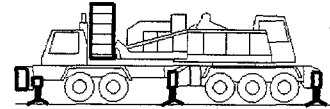

60 Ft. JIB

Jib Oper. Rad. Feet	5 Degree Offset			15 Degree Offset			25 Degree Offset			Jib Oper. Rad. Feet
	Boom Ang. Deg.	Jib Point Elev. Feet	Jib Capacity Pounds	Boom Ang. Deg.	Jib Point Elev. Feet	Jib Capacity Pounds	Boom Ang. Deg.	Jib Point Elev. Feet	Jib Capacity Pounds	
170 Ft. BOOM										
45	81.0	237.5	36,200*							45
50	79.7	236.5	35,600*							50
55	78.5	235.5	35,000*							55
60	77.2	234.3	34,300*	80.0	233.0	29,500*				60
65	75.9	233.0	33,800*	78.8	231.7	29,500*				65
70	74.6	231.5	33,200*	77.5	230.3	29,500*	80.1	226.8	26,800*	70
75	73.4	230.0	32,700*	76.2	228.7	29,200*	78.8	225.2	26,000*	75
80	72.1	228.3	32,100*	74.9	227.1	28,800*	77.5	223.5	25,100*	80
85	70.7	226.5	31,600*	73.5	225.3	28,500*	76.1	221.7	24,300*	85
90	69.4	224.5	31,200*	72.2	223.3	28,100*	74.8	219.8	23,600*	90
100	66.7	220.2	29,700*	69.5	219.1	27,400*	72.0	215.4	22,200*	100
110	64.0	215.4	25,900*	66.7	214.2	24,000*	69.2	210.5	21,000*	110
120	61.2	209.9	22,700*	63.9	208.8	21,200*	66.4	204.9	19,900*	120
130	58.3	203.8	20,000*	61.0	202.6	18,900*	63.4	198.7	18,000*	130
140	55.3	196.9	17,700*	58.0	195.7	16,800*	60.3	191.6	16,100*	140
150	52.2	189.2	15,800*	54.9	188.1	15,100*	57.1	183.8	14,500*	150
160	48.9	180.6	13,900	51.6	179.4	13,500*	53.7	174.9	13,100*	160
170	45.5	170.9	12,000	48.1	169.7	12,100*	50.2	164.9	11,800*	170
180	41.8	159.9	10,400	44.4	158.7	10,900*	46.4	153.6	10,700*	180
190	37.8	147.4	8,900	40.4	146.1	9,400	42.2	140.5	9,600*	190
200	33.5	132.7	7,500	36.0	131.5	8,000	37.6	125.1	8,300	200
210	28.5	115.2	6,300	31.0	113.8	6,700	32.2	106.3	6,900	210
220	22.5	92.9	5,200	24.8	91.2	5,500				220
230	14.0	60.1	4,100	16.1	57.4	4,300				230

Liftcrane Jib Capacities

Meets
ANSI B30.5
Requirements

Jib No. 134 With 12 Ft. 6 in. Strut On
Boom No. 78T With Heavy Lift Top
95,400 Lb. Crane Counterweight
25,000 Lb. Front Bumper Counterweight
360 Degree Rating On Fully Extended Outriggers

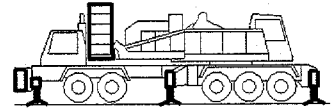

60 Ft. JIB

Jib Oper. Rad. Feet	5 Degree Offset			15 Degree Offset			25 Degree Offset			Jib Oper. Rad. Feet
	Boom Ang. Deg.	Jib Point Elev. Feet	Jib Capacity Pounds	Boom Ang. Deg.	Jib Point Elev. Feet	Jib Capacity Pounds	Boom Ang. Deg.	Jib Point Elev. Feet	Jib Capacity Pounds	
180 Ft. BOOM										
50	80.2	246.7	35,800*							50
55	79.0	245.7	35,200*							55
60	77.7	244.6	34,600*	80.5	243.3	29,500*				60
65	76.5	243.3	34,000*	79.2	242.0	29,500*				65
70	75.3	241.9	33,500*	78.0	240.7	29,500*	80.6	237.2	27,000*	70
75	74.1	240.4	33,000*	76.8	239.2	29,300*	79.3	235.7	26,300*	75
80	72.8	238.8	32,500*	75.5	237.6	28,900*	78.0	234.1	25,500*	80
85	71.6	237.1	32,000*	74.3	235.9	28,600*	76.8	232.3	24,700*	85
90	70.3	235.3	31,500*	73.0	234.0	28,200*	75.5	230.4	23,900*	90
100	67.8	231.2	30,600*	70.4	230.0	27,500*	72.9	226.3	22,600*	100
110	65.1	226.6	26,300*	67.8	225.4	24,300*	70.2	221.6	21,400*	110
120	62.5	221.4	23,100*	65.1	220.2	21,500*	67.5	216.4	20,200*	120
130	59.7	215.6	20,400*	62.4	214.4	19,100*	64.7	210.5	18,100*	130
140	56.9	209.1	18,000	59.5	207.9	17,000*	61.8	203.9	16,300*	140
150	54.0	201.9	15,500	56.6	200.7	15,200*	58.8	196.5	14,600*	150
160	51.0	193.9	13,400	53.5	192.7	13,700*	55.7	188.3	13,200*	160
170	47.8	184.9	11,500	50.4	183.8	12,200*	52.4	179.1	11,900*	170
180	44.4	174.9	9,900	47.0	173.7	10,500	48.9	168.8	10,700*	180
190	40.9	163.5	8,400	43.4	162.3	9,000	45.2	157.0	9,400	190
200	37.0	150.6	7,100	39.5	149.4	7,600	41.1	143.5	7,900	200
210	32.7	135.6	5,900	35.2	134.2	6,300	36.6	127.7	6,500	210
220	27.9	117.6	4,800	30.2	116.1	5,100	31.3	108.3	5,300	220
230	22.0	94.8	3,700	24.2	93.0	4,000				230
240	13.7	61.1	2,800	15.6	58.4	2,900				240



Liftcrane Jib Capacities

Meets
ANSI B30.5
Requirements

Jib No. 134 With 12 Ft. 6 in. Strut On
Boom No. 78T With Heavy Lift Top
95,400 Lb. Crane Counterweight
25,000 Lb. Front Bumper Counterweight
360 Degree Rating On Fully Extended Outriggers

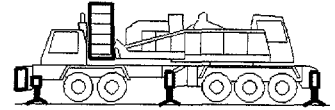

60 Ft. JIB

Jib Oper. Rad. Feet	5 Degree Offset			15 Degree Offset			25 Degree Offset			Jib Oper. Rad. Feet
	Boom Ang. Deg.	Jib Point Elev. Feet	Jib Capacity Pounds	Boom Ang. Deg.	Jib Point Elev. Feet	Jib Capacity Pounds	Boom Ang. Deg.	Jib Point Elev. Feet	Jib Capacity Pounds	
190 Ft. BOOM										
50	80.6	256.9	36,000*							50
55	79.4	255.9	35,400*							55
60	78.2	254.8	34,900*	80.9	253.5	29,500*				60
65	77.1	253.6	34,300*	79.7	252.3	29,500*				65
70	75.9	252.3	33,800*	78.5	251.0	29,500*	81.0	247.5	27,300*	70
75	74.7	250.9	33,300*	77.3	249.6	29,400*	79.8	246.1	26,500*	75
80	73.5	249.4	32,800*	76.1	248.1	29,000*	78.5	244.5	25,800*	80
85	72.3	247.7	32,300*	74.9	246.4	28,600*	77.3	242.8	25,000*	85
90	71.1	245.9	31,800*	73.7	244.7	28,300*	76.1	241.1	24,300*	90
100	68.7	242.0	30,900*	71.3	240.8	27,600*	73.6	237.1	22,900*	100
110	66.2	237.6	26,900*	68.8	236.4	24,700*	71.1	232.7	21,700*	110
120	63.7	232.7	23,600*	66.2	231.5	21,900*	68.5	227.7	20,500*	120
130	61.1	227.2	20,400	63.6	226.0	19,400*	65.8	222.1	18,400*	130
140	58.4	221.1	17,600	60.9	219.9	17,400*	63.1	215.9	16,500*	140
150	55.7	214.3	15,100	58.2	213.1	15,500*	60.3	208.9	14,800*	150
160	52.8	206.8	13,000	55.3	205.6	13,800	57.4	201.3	13,300*	160
170	49.9	198.5	11,100	52.3	197.3	11,900	54.3	192.7	12,000*	170
180	46.8	189.2	9,400	49.2	188.0	10,100	51.1	183.2	10,700	180
190	43.5	178.8	7,900	45.9	177.6	8,600	47.7	172.5	9,000	190
200	40.0	167.1	6,600	42.4	165.9	7,200	44.1	160.4	7,600	200
210	36.2	153.8	5,400	38.6	152.5	5,900	40.1	146.5	6,200	210
220	32.0	138.4	4,300	34.3	137.0	4,700	35.7	130.2	5,000	220
230	27.3	119.9	3,300	29.5	118.4	3,600	30.5	110.3	3,800	230
240	21.5	96.6	2,400	23.6	94.7	2,600				240



777T

Liftcrane Jib Capacities

Jib No. 134 With 12 Ft. 6 in. Strut On
Boom No. 78T With Heavy Lift Top
95,400 Lb. Crane Counterweight
25,000 Lb. Front Bumper Counterweight
360 Degree Rating On Fully Extended Outriggers

Meets
ANSI B30.5
Requirements

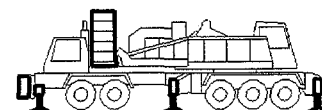

60 Ft. JIB

Jib Oper. Rad. Feet	5 Degree Offset			15 Degree Offset			25 Degree Offset			Jib Oper. Rad. Feet
	Boom Ang. Deg.	Jib Point Elev. Feet	Jib Capacity Pounds	Boom Ang. Deg.	Jib Point Elev. Feet	Jib Capacity Pounds	Boom Ang. Deg.	Jib Point Elev. Feet	Jib Capacity Pounds	
200 Ft. BOOM										
50	80.9	267.1	35,900*							50
55	79.8	266.1	35,400*							55
60	78.7	265.1	35,000*							60
65	77.6	263.9	34,500*	80.1	262.6	29,500*				65
70	76.4	262.7	34,000*	79.0	261.3	29,500*				70
75	75.3	261.3	33,600*	77.8	260.0	29,400*	80.2	256.4	26,800*	75
80	74.2	259.8	33,100*	76.7	258.5	29,000*	79.0	254.9	26,100*	80
85	73.0	258.3	32,600*	75.5	257.0	28,700*	77.8	253.3	25,400*	85
90	71.9	256.6	32,100*	74.4	255.3	28,300*	76.7	251.6	24,600*	90
100	69.5	252.8	31,200*	72.0	251.6	27,700*	74.3	247.9	23,300*	100
110	67.2	248.6	27,200*	69.6	247.4	25,000*	71.9	243.6	22,100*	110
120	64.8	243.9	23,400	67.2	242.7	22,100*	69.4	238.9	20,600*	120
130	62.3	238.7	20,000	64.7	237.5	19,600*	66.9	233.5	18,400*	130
140	59.8	232.9	17,100	62.2	231.7	17,500*	64.3	227.6	16,500*	140
150	57.2	226.5	14,600	59.6	225.3	15,500*	61.6	221.1	14,900*	150
160	54.5	219.4	12,500	56.9	218.2	13,400	58.9	213.9	12,900*	160
170	51.7	211.6	10,600	54.1	210.4	11,400	56.0	205.9	11,200*	170
180	48.8	202.9	8,900	51.2	201.7	9,700	53.0	197.0	9,700*	180
190	45.8	193.3	7,400	48.1	192.1	8,100	49.9	187.2	8,300*	190
200	42.6	182.6	6,100	44.9	181.4	6,700	46.6	176.1	7,000*	200
210	39.2	170.6	4,900	41.5	169.3	5,500	43.0	163.6	5,800	210
220	35.5	156.9	3,800	37.7	155.6	4,300	39.2	149.4	4,600	220
230	31.4	141.1	2,800	33.6	139.7	3,200	34.8	132.6	3,400	230
240				28.9	120.6	2,200	29.8	112.3	2,400	240



777T

Liftcrane Jib Capacities

Jib No. 134 With 12 Ft. 6 in. Strut On
Boom No. 78T With Heavy Lift Top
95,400 Lb. Crane Counterweight
25,000 Lb. Front Bumper Counterweight
360 Degree Rating On Fully Extended Outriggers

Meets
ANSI B30.5
Requirements

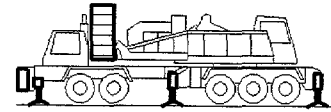

60 Ft. JIB

Jib Oper. Rad. Feet	5 Degree Offset			15 Degree Offset			25 Degree Offset			Jib Oper. Rad. Feet
	Boom Ang. Deg.	Jib Point Elev. Feet	Jib Capacity Pounds	Boom Ang. Deg.	Jib Point Elev. Feet	Jib Capacity Pounds	Boom Ang. Deg.	Jib Point Elev. Feet	Jib Capacity Pounds	
210 Ft. BOOM										
55	80.2	276.3	35,100*							55
60	79.1	275.3	34,700*							60
65	78.0	274.2	34,300*	80.5	272.8	29,500*				65
70	77.0	273.0	33,800*	79.4	271.6	29,500*				70
75	75.9	271.7	33,400*	78.3	270.3	29,300*	80.6	266.7	25,600*	75
80	74.8	270.3	33,000*	77.2	268.9	29,000*	79.4	265.3	24,800*	80
85	73.7	268.7	32,500*	76.1	267.4	28,700*	78.3	263.8	24,000*	85
90	72.6	267.1	32,100*	75.0	265.8	28,300*	77.2	262.2	23,300*	90
100	70.3	263.6	27,500*	72.7	262.3	24,700*	74.9	258.5	21,900*	100
110	68.1	259.5	23,800*	70.4	258.3	21,600*	72.6	254.5	20,000*	110
120	65.8	255.0	20,700*	68.1	253.8	19,000*	70.2	249.9	17,600*	120
130	63.4	250.1	18,100*	65.7	248.8	16,700*	67.8	244.9	15,700*	130
140	61.0	244.5	15,900*	63.3	243.3	14,800*	65.4	239.3	13,900*	140
150	58.5	238.4	13,900*	60.9	237.2	13,100*	62.9	233.1	12,400*	150
160	56.0	231.7	12,100	58.3	230.5	11,500*	60.3	226.3	11,000*	160
170	53.4	224.4	10,200	55.7	223.1	10,200*	57.6	218.7	9,700*	170
180	50.7	216.2	8,600	52.9	215.0	9,000*	54.8	210.4	8,600*	180
190	47.8	207.3	7,100	50.1	206.1	7,800	51.9	201.2	7,600*	190
200	44.9	197.4	5,800	47.1	196.1	6,400	48.8	191.1	6,700*	200
210	41.7	186.4	4,600	44.0	185.1	5,100	45.6	179.7	5,600	210
220	38.4	174.0	3,500	40.6	172.7	4,000	42.1	166.9	4,300	220
230	34.8	160.0	2,500	36.9	158.6	2,900	38.3	152.2	3,200	230
240							34.0	135.1	2,100	240

Liftcrane Jib Capacities

Meets
ANSI B30.5
Requirements

Jib No. 134 With 12 Ft. 6 in. Strut On
Boom No. 78T With Heavy Lift Top
95,400 Lb. Crane Counterweight
25,000 Lb. Front Bumper Counterweight
360 Degree Rating On Fully Extended Outriggers

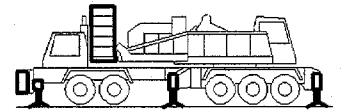

60 Ft. JIB

Jib Oper. Rad. Feet	5 Degree Offset			15 Degree Offset			25 Degree Offset			Jib Oper. Rad. Feet
	Boom Ang. Deg.	Jib Point Elev. Feet	Jib Capacity Pounds	Boom Ang. Deg.	Jib Point Elev. Feet	Jib Capacity Pounds	Boom Ang. Deg.	Jib Point Elev. Feet	Jib Capacity Pounds	
220 Ft. BOOM										
55	80.5	286.5	34,800*							55
60	79.5	285.5	34,400*							60
65	78.5	284.5	34,000*	80.8	283.1	29,500*				65
70	77.4	283.3	33,600*	79.8	281.9	29,500*				70
75	76.4	282.0	33,200*	78.7	280.7	29,200*	80.9	277.0	26,300*	75
80	75.3	280.7	32,800*	77.6	279.3	28,900*	79.8	275.7	25,600*	80
85	74.3	279.2	32,400*	76.6	277.9	28,600*	78.8	274.2	24,900*	85
90	73.2	277.7	32,000*	75.5	276.3	28,300*	77.7	272.6	24,200*	90
100	71.1	274.2	28,200*	73.4	272.9	25,100*	75.5	269.2	22,800*	100
110	68.9	270.4	24,400*	71.2	269.1	22,000*	73.3	265.3	20,200*	110
120	66.7	266.1	21,200*	69.0	264.8	19,300*	71.0	260.9	17,900*	120
130	64.4	261.3	18,700*	66.7	260.0	17,100*	68.7	256.1	15,900*	130
140	62.1	256.0	16,300*	64.4	254.8	15,100*	66.4	250.7	14,100*	140
150	59.8	250.2	14,000	62.0	249.0	13,400*	64.0	244.9	12,600*	150
160	57.4	243.9	11,800	59.6	242.6	11,800*	61.5	238.4	11,200*	160
170	54.9	236.9	9,900	57.1	235.6	10,500*	59.0	231.3	9,900*	170
180	52.3	229.2	8,300	54.5	228.0	9,100	56.3	223.5	8,800*	180
190	49.7	220.8	6,800	51.9	219.6	7,600	53.6	214.9	7,800*	190
200	46.9	211.6	5,500	49.1	210.3	6,200	50.8	205.4	6,700	200
210	44.0	201.4	4,300	46.2	200.1	4,900	47.8	194.9	5,400	210
220	40.9	190.0	3,200	43.1	188.7	3,800	44.6	183.2	4,100	220
230	37.7	177.3	2,200	39.8	176.0	2,700	41.2	170.0	3,000	230
240							37.4	155.0	2,000	240



777T

Liftcrane Jib Capacities

Jib No. 134 With 12 Ft. 6 in. Strut On
Boom No. 78T With Heavy Lift Top
95,400 Lb. Crane Counterweight
25,000 Lb. Front Bumper Counterweight
360 Degree Rating On Fully Extended Outriggers

Meets
ANSI B30.5
Requirements

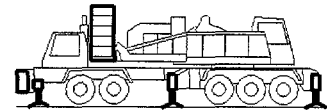

70 Ft. JIB

Jib Oper. Rad. Feet	5 Degree Offset			15 Degree Offset			25 Degree Offset			Jib Oper. Rad. Feet
	Boom Ang. Deg.	Jib Point Elev. Feet	Jib Capacity Pounds	Boom Ang. Deg.	Jib Point Elev. Feet	Jib Capacity Pounds	Boom Ang. Deg.	Jib Point Elev. Feet	Jib Capacity Pounds	
100 Ft. BOOM										
40	79.6	177.6	27,100*							40
45	77.9	176.5	26,600*							45
50	76.2	175.2	26,000*	80.3	173.9	23,900*				50
55	74.5	173.7	25,400*	78.6	172.5	23,400*				55
60	72.7	172.1	24,800*	76.8	170.8	22,900*				60
65	70.9	170.3	24,200*	75.1	169.0	22,500*	79.4	165.9	20,700*	65
70	69.2	168.4	23,700*	73.3	167.1	22,000*	77.5	163.9	20,300*	70
75	67.4	166.2	23,200*	71.4	164.9	21,600*	75.7	161.7	20,000*	75
80	65.5	163.9	22,700*	69.6	162.5	21,100*	73.8	159.2	19,500*	80
85	63.6	161.3	22,200*	67.7	160.0	20,700*	71.8	156.6	18,600*	85
90	61.7	158.6	21,800*	65.8	157.2	20,300*	69.9	153.8	17,900*	90
100	57.8	152.4	20,900*	61.8	150.9	19,600*	65.8	147.4	16,500*	100
110	53.7	145.2	20,000*	57.7	143.6	18,800*	61.6	139.9	15,400*	110
120	49.4	136.8	19,200*	53.3	135.2	18,200*	57.0	131.1	14,400*	120
130	44.7	127.0	18,500*	48.6	125.2	17,300*	52.1	120.8	13,600*	130
140	39.6	115.3	17,900*	43.4	113.4	16,100*	46.7	108.5	12,900*	140
150	33.8	101.1	17,300*	37.5	98.9	15,100*	40.5	93.1	12,300*	150
160	27.0	83.0	16,500*	30.3	80.1	14,300*	32.7	72.8	11,900*	160
170	17.5	56.5	15,000	20.3	51.9	13,700*				170



Liftcrane Jib Capacities

Jib No. 134 With 12 Ft. 6 in. Strut On
 Boom No. 78T With Heavy Lift Top
 95,400 Lb. Crane Counterweight
 25,000 Lb. Front Bumper Counterweight
 360 Degree Rating On Fully Extended Outriggers

Meets
ANSI B30.5
Requirements

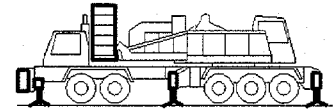

70 Ft. JIB

Jib Oper. Rad. Feet	5 Degree Offset			15 Degree Offset			25 Degree Offset			Jib Oper. Rad. Feet
	Boom Ang. Deg.	Jib Point Elev. Feet	Jib Capacity Pounds	Boom Ang. Deg.	Jib Point Elev. Feet	Jib Capacity Pounds	Boom Ang. Deg.	Jib Point Elev. Feet	Jib Capacity Pounds	
110 Ft. BOOM										
40	80.2	187.8	27,200 *							40
45	78.6	186.7	26,900 *							45
50	77.0	185.5	26,300 *	80.9	184.2	24,100*				50
55	75.3	184.2	25,700 *	79.3	182.9	23,600*				55
60	73.7	182.6	25,100 *	77.6	181.3	23,100*				60
65	72.0	181.0	24,600 *	75.9	179.6	22,700*	80.0	176.4	20,900*	65
70	70.4	179.1	24,100 *	74.2	177.8	22,300*	78.3	174.5	20,500*	70
75	68.7	177.1	23,600 *	72.5	175.7	21,800*	76.5	172.4	20,100*	75
80	67.0	174.9	23,100 *	70.8	173.5	21,400*	74.8	170.2	19,800*	80
85	65.2	172.5	22,600 *	69.0	171.1	21,000*	73.0	167.7	19,100*	85
90	63.4	170.0	22,200 *	67.3	168.6	20,600*	71.1	165.1	18,300*	90
100	59.8	164.2	21,300 *	63.6	162.8	19,900*	67.4	159.2	17,000*	100
110	56.1	157.6	20,500 *	59.8	156.1	19,200*	63.5	152.3	15,900*	110
120	52.1	150.0	19,700 *	55.8	148.4	18,600*	59.4	144.4	14,900*	120
130	47.9	141.1	19,000 *	51.5	139.4	18,000*	55.0	135.2	14,000*	130
140	43.4	130.9	18,300 *	47.0	129.0	16,900*	50.3	124.3	13,300*	140
150	38.4	118.7	17,700 *	41.9	116.6	15,800*	45.0	111.4	12,700*	150
160	32.8	104.0	16,600 *	36.2	101.6	15,000*	38.9	95.5	12,200*	160
170	26.1	85.2	14,700 *	29.3	82.2	14,200*	31.4	74.3	11,900*	170
180	17.0	57.9	13,000 *	19.5	53.0	13,100				180



777T

Liftcrane Jib Capacities

Meets
ANSI B30.5
Requirements

Jib No. 134 With 12 Ft. 6 in. Strut On
Boom No. 78T With Heavy Lift Top
95,400 Lb. Crane Counterweight
25,000 Lb. Front Bumper Counterweight
360 Degree Rating On Fully Extended Outriggers

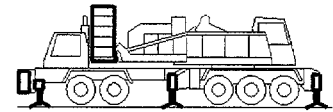

70 Ft. JIB

Jib Oper. Rad. Feet	5 Degree Offset			15 Degree Offset			25 Degree Offset			Jib Oper. Rad. Feet
	Boom Ang. Deg.	Jib Point Elev. Feet	Jib Capacity Pounds	Boom Ang. Deg.	Jib Point Elev. Feet	Jib Capacity Pounds	Boom Ang. Deg.	Jib Point Elev. Feet	Jib Capacity Pounds	
120 Ft. BOOM										
40	80.7	198.0	27,300*							40
45	79.2	197.0	27,100*							45
50	77.7	195.8	26,500*							50
55	76.1	194.5	26,000*	79.8	193.2	23,800*				55
60	74.6	193.1	25,400*	78.3	191.8	23,300*				60
65	73.0	191.5	24,900*	76.7	190.2	22,900*	80.6	186.9	21,000*	65
70	71.4	189.8	24,400*	75.1	188.4	22,500*	78.9	185.1	20,600*	70
75	69.8	187.9	23,900*	73.5	186.5	22,100*	77.3	183.1	20,300*	75
80	68.2	185.8	23,500*	71.9	184.4	21,700*	75.6	181.0	20,000*	80
85	66.6	183.6	23,000*	70.2	182.2	21,300*	74.0	178.7	19,500*	85
90	64.9	181.2	22,600*	68.6	179.8	20,900*	72.3	176.3	18,800*	90
100	61.6	175.9	21,700*	65.2	174.4	20,200*	68.8	170.7	17,500*	100
110	58.1	169.7	20,900*	61.6	168.2	19,500*	65.2	164.4	16,300*	110
120	54.4	162.7	20,200*	57.9	161.1	18,900*	61.4	157.1	15,300*	120
130	50.6	154.6	19,400*	54.1	152.9	18,300*	57.4	148.7	14,500*	130
140	46.5	145.4	18,800*	50.0	143.5	17,600*	53.2	139.0	13,700*	140
150	42.2	134.6	18,200*	45.5	132.6	16,600*	48.5	127.7	13,100*	150
160	37.4	122.0	16,400	40.6	119.8	15,600*	43.4	114.3	12,600*	160
170	31.9	106.7	14,500	35.1	104.2	14,800*	37.5	97.7	12,100*	170
180	25.4	87.3	12,900	28.3	84.1	13,200	30.2	75.7	11,800*	180
190	16.5	59.2	11,300	18.8	54.0	11,500				190



Liftcrane Jib Capacities

Meets
 ANSI B30.5
 Requirements

Jib No. 134 With 12 Ft. 6 in. Strut On
 Boom No. 78T With Heavy Lift Top
 95,400 Lb. Crane Counterweight
 25,000 Lb. Front Bumper Counterweight
 360 Degree Rating On Fully Extended Outriggers

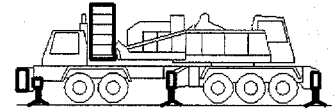

70 Ft. JIB

Jib Oper. Rad. Feet	5 Degree Offset			15 Degree Offset			25 Degree Offset			Jib Oper. Rad. Feet
	Boom Ang. Deg.	Jib Point Elev. Feet	Jib Capacity Pounds	Boom Ang. Deg.	Jib Point Elev. Feet	Jib Capacity Pounds	Boom Ang. Deg.	Jib Point Elev. Feet	Jib Capacity Pounds	
130 Ft. BOOM										
45	79.7	207.2	27,200*							45
50	78.3	206.1	26,800*							50
55	76.8	204.9	26,200*	80.4	203.5	23,900*				55
60	75.4	203.5	25,700*	78.9	202.2	23,500*				60
65	73.9	202.0	25,200*	77.4	200.6	23,100*				65
70	72.4	200.4	24,700*	75.9	199.0	22,700*	79.5	195.6	20,700*	70
75	70.9	198.6	24,200*	74.4	197.2	22,300*	78.0	193.7	20,400*	75
80	69.4	196.7	23,800*	72.8	195.2	21,900*	76.4	191.7	20,100*	80
85	67.8	194.6	23,300*	71.3	193.1	21,500*	74.8	189.6	19,800*	85
90	66.3	192.3	22,900*	69.7	190.9	21,200*	73.2	187.3	19,200*	90
100	63.1	187.3	22,100*	66.5	185.8	20,500*	70.0	182.1	17,900*	100
110	59.8	181.6	21,300*	63.2	180.0	19,800*	66.6	176.2	16,800*	110
120	56.5	175.0	20,600*	59.8	173.4	19,200*	63.1	169.5	15,800*	120
130	52.9	167.6	19,900*	56.2	165.9	18,600*	59.5	161.7	14,900*	130
140	49.2	159.1	19,200*	52.5	157.3	18,100*	55.6	152.9	14,100*	140
150	45.3	149.5	18,100	48.5	147.5	17,200*	51.5	142.8	13,500*	150
160	41.0	138.3	16,000	44.2	136.2	16,300*	47.0	131.0	12,900*	160
170	36.4	125.2	14,100	39.4	122.9	14,600	42.0	117.1	12,400*	170
180	31.1	109.4	12,400	34.0	106.7	12,800	36.2	99.9	12,100*	180
190	24.7	89.4	10,900	27.5	86.0	11,200	29.0	77.2	11,400	190
200	16.0	60.5	9,500	18.2	55.0	9,700				200



Liftcrane Jib Capacities

Jib No. 134 With 12 Ft. 6 in. Strut On
 Boom No. 78T With Heavy Lift Top
 95,400 Lb. Crane Counterweight
 25,000 Lb. Front Bumper Counterweight
 360 Degree Rating On Fully Extended Outriggers

Meets
 ANSI B30.5
 Requirements

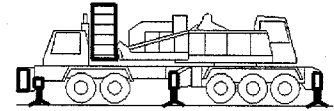

70 Ft. JIB

Jib Oper. Rad. Feet	5 Degree Offset			15 Degree Offset			25 Degree Offset			Jib Oper. Rad. Feet
	Boom Ang. Deg.	Jib Point Elev. Feet	Jib Capacity Pounds	Boom Ang. Deg.	Jib Point Elev. Feet	Jib Capacity Pounds	Boom Ang. Deg.	Jib Point Elev. Feet	Jib Capacity Pounds	
150 Ft. BOOM										
45	80.7	227.6	27,300*							45
50	79.4	226.6	27,100*							50
55	78.0	225.5	26,700*							55
60	76.7	224.2	26,200*	79.9	222.8	23,800*				60
65	75.4	222.9	25,700*	78.6	221.5	23,400*				65
70	74.0	221.4	25,300*	77.2	220.0	23,000*	80.5	216.4	21,000*	70
75	72.7	219.8	24,800*	75.9	218.3	22,700*	79.1	214.8	20,700*	75
80	71.3	218.1	24,400*	74.5	216.6	22,300*	77.7	213.0	20,400*	80
85	69.9	216.2	24,000*	73.1	214.7	22,000*	76.3	211.1	20,100*	85
90	68.5	214.2	23,600*	71.7	212.7	21,600*	74.9	209.0	19,800*	90
100	65.7	209.7	22,800*	68.8	208.2	21,000*	72.0	204.4	18,700*	100
110	62.8	204.6	22,000*	65.9	203.1	20,300*	69.0	199.2	17,600*	110
120	59.9	198.9	21,300*	62.9	197.3	19,800*	66.0	193.3	16,600*	120
130	56.8	192.4	20,600*	59.8	190.7	19,200*	62.8	186.6	15,700*	130
140	53.6	185.2	19,500	56.6	183.4	18,700*	59.5	179.1	14,900*	140
150	50.3	177.0	17,000	53.3	175.1	17,800	56.1	170.6	14,200*	150
160	46.8	167.8	14,900	49.7	165.8	15,600	52.4	161.0	13,600*	160
170	43.0	157.3	13,000	45.9	155.2	13,600	48.5	150.1	13,100*	170
180	39.0	145.3	11,300	41.8	143.0	11,900	44.2	137.4	12,300	180
190	34.6	131.3	9,900	37.3	128.8	10,300	39.5	122.4	10,700	190
200	29.5	114.6	8,500	32.2	111.6	8,900	34.0	104.1	9,100	200
210	23.5	93.5	7,300	25.9	89.7	7,500	27.1	80.0	7,700	210
220	15.2	63.0	6,100	17.0	57.0	6,300				220



777T

Liftcrane Jib Capacities

Meets
 ANSI B30.5
 Requirements

Jib No. 134 With 12 Ft. 6 in. Strut On
 Boom No. 78T With Heavy Lift Top
 95,400 Lb. Crane Counterweight
 25,000 Lb. Front Bumper Counterweight
 360 Degree Rating On Fully Extended Outriggers

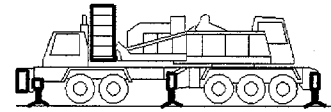

70 Ft. JIB

Jib Oper. Rad. Feet	5 Degree Offset			15 Degree Offset			25 Degree Offset			Jib Oper. Rad. Feet
	Boom Ang. Deg.	Jib Point Elev. Feet	Jib Capacity Pounds	Boom Ang. Deg.	Jib Point Elev. Feet	Jib Capacity Pounds	Boom Ang. Deg.	Jib Point Elev. Feet	Jib Capacity Pounds	
160 Ft. BOOM										
50	79.8	236.8	27,200*							50
55	78.6	235.7	26,900*							55
60	77.3	234.6	26,400*	80.4	233.1	23,900*				60
65	76.0	233.3	26,000*	79.1	231.8	23,600*				65
70	74.7	231.9	25,500*	77.8	230.4	23,200*	81.0	226.8	21,100*	70
75	73.5	230.3	25,100*	76.5	228.8	22,800*	79.6	225.2	20,800*	75
80	72.2	228.7	24,600*	75.2	227.2	22,500*	78.3	223.5	20,500*	80
85	70.8	226.9	24,200*	73.9	225.4	22,200*	77.0	221.7	20,200*	85
90	69.5	225.0	23,800*	72.5	223.4	21,800*	75.6	219.7	19,900*	90
100	66.8	220.7	23,100*	69.8	219.2	21,200*	72.9	215.4	19,000*	100
110	64.1	215.9	22,400*	67.1	214.3	20,600*	70.1	210.4	17,900*	110
120	61.3	210.5	21,700*	64.2	208.9	20,000*	67.2	204.9	16,900*	120
130	58.4	204.4	21,000*	61.3	202.7	19,500*	64.2	198.6	16,100*	130
140	55.4	197.6	19,000	58.3	195.9	18,100*	61.1	191.6	15,300*	140
150	52.3	190.0	16,600	55.2	188.2	16,300*	57.9	183.7	14,600*	150
160	49.1	181.5	14,400	51.9	179.6	14,700*	54.5	174.9	14,000*	160
170	45.7	171.9	12,600	48.5	169.9	13,200	51.0	164.9	12,800*	170
180	42.0	161.1	10,900	44.8	158.9	11,500	47.2	153.5	11,600*	180
190	38.1	148.7	9,400	40.8	146.3	9,900	43.0	140.4	10,400	190
200	33.8	134.3	8,100	36.4	131.6	8,500	38.4	125.0	8,800	200
210	28.9	117.1	6,900	31.3	114.0	7,200	33.0	106.2	7,400	210
220	23.0	95.4	5,800	25.2	91.5	6,000	26.3	81.3	6,100	220
230	14.9	64.2	4,700	16.5	57.9	4,800				230



Liftcrane Jib Capacities

Jib No. 134 With 12 Ft. 6 in. Strut On
 Boom No. 78T With Heavy Lift Top
 95,400 Lb. Crane Counterweight
 25,000 Lb. Front Bumper Counterweight
 360 Degree Rating On Fully Extended Outriggers

Meets
 ANSI B30.5
 Requirements

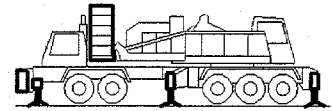

70 Ft. JIB

Jib Oper. Rad. Feet	5 Degree Offset			15 Degree Offset			25 Degree Offset			Jib Oper. Rad. Feet
	Boom Ang. Deg.	Jib Point Elev. Feet	Jib Capacity Pounds	Boom Ang. Deg.	Jib Point Elev. Feet	Jib Capacity Pounds	Boom Ang. Deg.	Jib Point Elev. Feet	Jib Capacity Pounds	
170 Ft. BOOM										
50	80.3	247.0	27,200*							50
55	79.0	246.0	27,100*							55
60	77.8	244.8	26,600*	80.8	243.4	24,100*				60
65	76.6	243.6	26,200*	79.5	242.1	23,700*				65
70	75.4	242.3	25,700*	78.3	240.8	23,300*				70
75	74.2	240.8	25,300*	77.1	239.3	23,000*	80.1	235.6	20,900*	75
80	72.9	239.2	24,900*	75.8	237.7	22,700*	78.8	234.0	20,600*	80
85	71.7	237.5	24,500*	74.6	236.0	22,300*	77.6	232.3	20,300*	85
90	70.4	235.7	24,100*	73.3	234.1	22,000*	76.3	230.4	20,100*	90
100	67.9	231.7	23,400*	70.7	230.1	21,400*	73.6	226.3	19,400*	100
110	65.3	227.1	22,700*	68.1	225.5	20,800*	71.0	221.6	18,300*	110
120	62.6	222.0	22,000*	65.4	220.3	20,200*	68.3	216.3	17,300*	120
130	59.9	216.2	20,300*	62.7	214.5	19,000*	65.4	210.4	16,400*	130
140	57.1	209.8	18,000*	59.8	208.1	16,800*	62.6	203.8	15,600*	140
150	54.2	202.7	15,900*	56.9	200.9	15,100*	59.6	196.5	14,300*	150
160	51.1	194.7	14,200	53.9	192.9	13,500*	56.4	188.2	12,900*	160
170	48.0	185.9	12,300	50.7	183.9	12,100*	53.1	179.0	11,600*	170
180	44.6	175.9	10,600	47.3	173.9	10,800*	49.7	168.7	10,500*	180
190	41.1	164.7	9,200	43.7	162.5	9,700	45.9	156.9	9,400*	190
200	37.3	152.0	7,800	39.8	149.5	8,300	41.9	143.4	8,500*	200
210	33.0	137.2	6,600	35.5	134.4	7,000	37.4	127.6	7,400	210
220	28.2	119.5	5,500	30.6	116.3	5,900	32.1	108.2	6,100	220
230	22.5	97.3	4,500	24.6	93.3	4,800				230
240	14.5	65.4	3,600	16.0	58.9	3,700				240



777T

Liftcrane Jib Capacities

Jib No. 134 With 12 Ft. 6 in. Strut On
Boom No. 78T With Heavy Lift Top
95,400 Lb. Crane Counterweight
25,000 Lb. Front Bumper Counterweight
360 Degree Rating On Fully Extended Outriggers

Meets
ANSI B30.5
Requirements

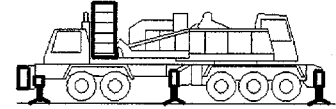

70 Ft. JIB

Jib Oper. Rad. Feet	5 Degree Offset			15 Degree Offset			25 Degree Offset			Jib Oper. Rad. Feet
	Boom Ang. Deg.	Jib Point Elev. Feet	Jib Capacity Pounds	Boom Ang. Deg.	Jib Point Elev. Feet	Jib Capacity Pounds	Boom Ang. Deg.	Jib Point Elev. Feet	Jib Capacity Pounds	
180 Ft. BOOM										
50	80.6	257.2	27,300*							50
55	79.5	256.2	27,100*							55
60	78.3	255.1	26,800*							60
65	77.2	253.9	26,400*	80.0	252.4	23,800*				65
70	76.0	252.6	26,000*	78.8	251.1	23,500*				70
75	74.8	251.2	25,500*	77.6	249.7	23,100*	80.5	246.0	20,900*	75
80	73.6	249.7	25,100*	76.4	248.2	22,800*	79.3	244.4	20,700*	80
85	72.4	248.1	24,700*	75.2	246.5	22,500*	78.1	242.8	20,400*	85
90	71.2	246.3	24,400*	74.0	244.8	22,200*	76.8	241.0	20,200*	90
100	68.8	242.5	23,600*	71.5	240.9	21,600*	74.4	237.1	19,700*	100
110	66.3	238.1	22,900*	69.1	236.5	21,000*	71.8	232.6	18,600*	110
120	63.8	233.3	22,300*	66.5	231.6	20,500*	69.2	227.6	17,600*	120
130	61.2	227.8	20,700*	63.9	226.1	19,100*	66.6	222.0	16,700*	130
140	58.5	221.8	18,300	61.2	220.0	17,000*	63.8	215.8	16,000*	140
150	55.8	215.0	15,800	58.5	213.3	15,200*	61.0	208.9	14,400*	150
160	53.0	207.6	13,700	55.6	205.7	13,600*	58.1	201.2	13,000*	160
170	50.0	199.3	11,800	52.6	197.4	12,200*	55.1	192.6	11,700*	170
180	46.9	190.2	10,200	49.5	188.1	10,900	51.8	183.1	10,500*	180
190	43.7	179.9	8,700	46.2	177.7	9,300	48.5	172.4	9,500*	190
200	40.2	168.3	7,400	42.7	166.0	7,900	44.8	160.3	8,400	200
210	36.5	155.2	6,200	38.9	152.7	6,600	40.8	146.4	7,000	210
220	32.3	140.0	5,100	34.7	137.2	5,500	36.4	130.0	5,700	220
230	27.6	121.9	4,100	29.8	118.6	4,400	31.2	110.2	4,600	230
240	22.0	99.2	3,100	24.0	95.0	3,300				240
250	14.2	66.6	2,200	15.6	59.8	2,300				250



Liftcrane Jib Capacities

Meets
ANSI B30.5
Requirements

Jib No. 134 With 12 Ft. 6 in. Strut On
Boom No. 78T With Heavy Lift Top
95,400 Lb. Crane Counterweight
25,000 Lb. Front Bumper Counterweight
360 Degree Rating On Fully Extended Outriggers

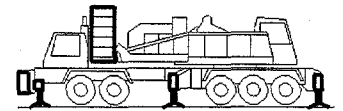

70 Ft. JIB

Jib Oper. Rad. Feet	5 Degree Offset			15 Degree Offset			25 Degree Offset			Jib Oper. Rad. Feet
	Boom Ang. Deg.	Jib Point Elev. Feet	Jib Capacity Pounds	Boom Ang. Deg.	Jib Point Elev. Feet	Jib Capacity Pounds	Boom Ang. Deg.	Jib Point Elev. Feet	Jib Capacity Pounds	
190 Ft. BOOM										
50	81.0	267.3	27,300*							50
55	79.9	266.4	27,200*							55
60	78.8	265.3	27,000*							60
65	77.7	264.2	26,600*	80.4	262.7	23,900*				65
70	76.5	263.0	26,200*	79.2	261.4	23,600*				70
75	75.4	261.6	25,800*	78.1	260.1	23,300*	80.9	256.3	21,000*	75
80	74.3	260.2	25,400*	77.0	258.6	23,000*	79.7	254.9	20,800*	80
85	73.1	258.6	25,000*	75.8	257.1	22,700*	78.6	253.3	20,500*	85
90	72.0	256.9	24,600*	74.6	255.4	22,400*	77.4	251.5	20,300*	90
100	69.6	253.3	23,900*	72.3	251.7	21,800*	75.0	247.8	19,800*	100
110	67.3	249.1	23,200*	69.9	247.5	21,200*	72.6	243.5	18,900*	110
120	64.9	244.5	22,600*	67.5	242.8	20,700*	70.1	238.8	17,900*	120
130	62.4	239.3	20,700	65.0	237.6	19,500*	67.6	233.5	17,100*	130
140	59.9	233.5	17,800	62.5	231.8	17,300*	65.0	227.6	16,200*	140
150	57.3	227.2	15,400	59.9	225.4	15,500*	62.3	221.0	14,600*	150
160	54.6	220.2	13,200	57.2	218.3	13,800*	59.6	213.8	13,100*	160
170	51.9	212.4	11,400	54.4	210.5	12,200	56.7	205.8	11,800*	170
180	49.0	203.8	9,700	51.5	201.8	10,400	53.8	196.9	10,600*	180
190	46.0	194.3	8,200	48.4	192.2	8,900	50.6	187.1	9,400*	190
200	42.8	183.7	6,900	45.2	181.5	7,500	47.3	176.0	8,000	200
210	39.4	171.9	5,700	41.8	169.5	6,200	43.7	163.5	6,700	210
220	35.7	158.4	4,600	38.0	155.7	5,100	39.9	149.2	5,400	220
230	31.7	142.8	3,600	33.9	139.8	4,000	35.5	132.5	4,300	230
240	27.1	124.2	2,700	29.2	120.8	3,000	30.5	112.1	3,200	240
250				23.4	96.7	2,000				250



777T

Liftcrane Jib Capacities

Jib No. 134 With 12 Ft. 6 in. Strut On
Boom No. 78T With Heavy Lift Top
95,400 Lb. Crane Counterweight
25,000 Lb. Front Bumper Counterweight
360 Degree Rating On Fully Extended Outriggers

Meets
ANSI B30.5
Requirements

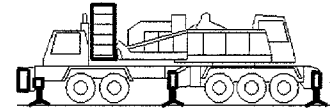

70 Ft. JIB

Jib Oper. Rad. Feet	5 Degree Offset			15 Degree Offset			25 Degree Offset			Jib Oper. Rad. Feet
	Boom Ang. Deg.	Jib Point Elev. Feet	Jib Capacity Pounds	Boom Ang. Deg.	Jib Point Elev. Feet	Jib Capacity Pounds	Boom Ang. Deg.	Jib Point Elev. Feet	Jib Capacity Pounds	
200 Ft. BOOM										
55	80.3	276.6	27,200*							55
60	79.2	275.6	27,100*							60
65	78.1	274.5	26,800*	80.7	272.9	24,100*				65
70	77.0	273.3	26,400*	79.6	271.7	23,700*				70
75	75.9	272.0	26,000*	78.5	270.4	23,400*				75
80	74.9	270.6	25,600*	77.4	269.0	23,100*	80.1	265.2	20,900*	80
85	73.8	269.1	25,200*	76.3	267.5	22,800*	79.0	263.7	20,600*	85
90	72.7	267.5	24,900*	75.2	265.9	22,500*	77.9	262.1	20,400*	90
100	70.4	264.0	24,200*	73.0	262.4	22,000*	75.6	258.5	19,900*	100
110	68.2	260.0	23,500*	70.7	258.4	21,400*	73.3	254.4	19,200*	110
120	65.9	255.5	22,800*	68.4	253.9	20,900*	70.9	249.8	18,200*	120
130	63.5	250.6	20,200	66.0	248.9	19,600*	68.5	244.8	17,400*	130
140	61.1	245.1	17,400	63.6	243.4	17,500*	66.1	239.2	16,300*	140
150	58.6	239.1	14,900	61.1	237.3	15,500*	63.5	233.0	14,600*	150
160	56.1	232.5	12,700	58.6	230.6	13,500*	60.9	226.1	12,900*	160
170	53.5	225.2	10,900	56.0	223.3	11,700	58.3	218.6	11,200*	170
180	50.8	217.1	9,200	53.2	215.1	10,000	55.5	210.3	9,700*	180
190	48.0	208.2	7,700	50.4	206.2	8,400	52.6	201.1	8,300*	190
200	45.0	198.4	6,400	47.4	196.3	7,000	49.5	190.9	7,100*	200
210	41.9	187.5	5,200	44.3	185.2	5,800	46.2	179.5	6,000*	210
220	38.6	175.3	4,100	40.9	172.8	4,600	42.7	166.7	4,900*	220
230	35.0	161.4	3,100	37.2	158.7	3,500	38.9	152.0	3,900	230
240	31.0	145.5	2,200	33.2	142.5	2,600	34.7	134.9	2,800	240



Liftcrane Jib Capacities

Meets
ANSI B30.5
Requirements

Jib No. 134 With 12 Ft. 6 in. Strut On
Boom No. 78T With Heavy Lift Top
95,400 Lb. Crane Counterweight
25,000 Lb. Front Bumper Counterweight
360 Degree Rating On Fully Extended Outriggers

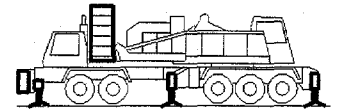

70 Ft. JIB

Jib Oper. Rad. Feet	5 Degree Offset			15 Degree Offset			25 Degree Offset			Jib Oper. Rad. Feet
	Boom Ang. Deg.	Jib Point Elev. Feet	Jib Capacity Pounds	Boom Ang. Deg.	Jib Point Elev. Feet	Jib Capacity Pounds	Boom Ang. Deg.	Jib Point Elev. Feet	Jib Capacity Pounds	
210 Ft. BOOM										
55	80.6	286.7	27,300*							55
60	79.6	285.8	27,100*							60
65	78.5	284.7	26,900*							65
70	77.5	283.6	26,500*	80.0	282.0	23,800*				70
75	76.5	282.3	26,100*	79.0	280.8	23,500*				75
80	75.4	281.0	25,700*	77.9	279.4	23,200*	80.5	275.6	20,900*	80
85	74.4	279.6	25,300*	76.8	278.0	22,900*	79.4	274.1	20,700*	85
90	73.3	278.0	25,000*	75.8	276.4	22,600*	78.3	272.5	20,400*	90
100	71.1	274.6	24,300*	73.6	273.0	22,000*	76.2	269.1	20,000*	100
110	69.0	270.8	23,600*	71.4	269.2	21,500*	73.9	265.2	18,800*	110
120	66.8	266.5	21,100*	69.2	264.9	19,100*	71.7	260.8	17,400*	120
130	64.5	261.8	18,400*	67.0	260.1	16,700*	69.4	256.0	15,400*	130
140	62.2	256.6	16,100*	64.6	254.9	14,800*	67.0	250.6	13,700*	140
150	59.9	250.9	14,100*	62.3	249.1	13,000*	64.6	244.7	12,200*	150
160	57.5	244.5	12,400	59.9	242.7	11,500*	62.2	238.3	10,800*	160
170	55.0	237.6	10,500	57.4	235.7	10,100*	59.6	231.1	9,600*	170
180	52.5	230.0	8,800	54.8	228.1	8,900*	57.0	223.3	8,400*	180
190	49.8	221.7	7,300	52.1	219.7	7,800*	54.3	214.7	7,400*	190
200	47.1	212.5	6,000	49.4	210.4	6,700	51.4	205.2	6,500*	200
210	44.2	202.4	4,800	46.4	200.2	5,400	48.4	194.7	5,700*	210
220	41.1	191.2	3,700	43.4	188.8	4,300	45.2	183.0	4,800	220
230	37.9	178.7	2,800	40.1	176.1	3,200	41.8	169.8	3,600	230
240				36.5	161.7	2,300	38.1	154.8	2,600	240



777T

Liftcrane Jib Capacities

Meets
ANSI B30.5
Requirements

Jib No. 134 With 12 Ft. 6 in. Strut On
Boom No. 78T With Heavy Lift Top
95,400 Lb. Crane Counterweight
25,000 Lb. Front Bumper Counterweight
360 Degree Rating On Fully Extended Outriggers

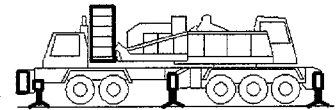

70 Ft. JIB

Jib Oper. Rad. Feet	5 Degree Offset			15 Degree Offset			25 Degree Offset			Jib Oper. Rad. Feet
	Boom Ang. Deg.	Jib Point Elev. Feet	Jib Capacity Pounds	Boom Ang. Deg.	Jib Point Elev. Feet	Jib Capacity Pounds	Boom Ang. Deg.	Jib Point Elev. Feet	Jib Capacity Pounds	
220 Ft. BOOM										
55	80.9	296.9	27,300*							55
60	79.9	296.0	27,200*							60
65	78.9	295.0	27,000*							65
70	77.9	293.8	26,700*	80.4	292.3	23,900*				70
75	76.9	292.6	26,300*	79.4	291.1	23,600*				75
80	75.9	291.4	25,900*	78.3	289.8	23,300*	80.8	285.9	21,000*	80
85	74.9	290.0	25,600*	77.3	288.4	23,000*	79.8	284.5	20,700*	85
90	73.9	288.5	25,200*	76.3	286.9	22,800*	78.8	283.0	20,500*	90
100	71.8	285.2	24,500*	74.2	283.6	22,200*	76.7	279.6	20,100*	100
110	69.7	281.6	23,900*	72.1	279.9	21,700*	74.5	275.9	19,700*	110
120	67.6	277.5	21,700*	70.0	275.8	19,400*	72.4	271.7	17,600*	120
130	65.5	272.9	19,000*	67.8	271.2	17,100*	70.2	267.1	15,600*	130
140	63.3	267.9	16,600*	65.6	266.2	15,100*	67.9	262.0	13,900*	140
150	61.0	262.5	14,200	63.4	260.7	13,300*	65.6	256.3	12,300*	150
160	58.7	256.4	12,100	61.0	254.6	11,800*	63.3	250.2	11,000*	160
170	56.4	249.9	10,200	58.7	248.0	10,300*	60.9	243.4	9,700*	170
180	54.0	242.7	8,500	56.2	240.7	9,100*	58.4	236.0	8,600*	180
190	51.5	234.8	7,100	53.7	232.8	7,800	55.8	227.9	7,600*	190
200	48.9	226.2	5,700	51.1	224.1	6,500	53.1	219.0	6,700*	200
210	46.2	216.8	4,500	48.4	214.6	5,200	50.4	209.3	5,800	210
220	43.4	206.4	3,500	45.5	204.1	4,000	47.4	198.4	4,500	220
230	40.4	194.8	2,500	42.5	192.4	3,000	44.3	186.4	3,400	230
240				39.3	179.4	2,000	40.9	172.9	2,400	240



Liftcrane Jib Capacities

Meets
ANSI B30.5
Requirements

Jib No. 134 With 12 Ft. 6 in. Strut On
Boom No. 78T With Heavy Lift Top
95,400 Lb. Crane Counterweight
25,000 Lb. Front Bumper Counterweight
360 Degree Rating On Fully Extended Outriggers

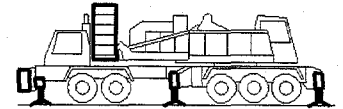

80 Ft. JIB

Jib Oper. Rad. Feet	5 Degree Offset			15 Degree Offset			25 Degree Offset			Jib Oper. Rad. Feet
	Boom Ang. Deg.	Jib Point Elev. Feet	Jib Capacity Pounds	Boom Ang. Deg.	Jib Point Elev. Feet	Jib Capacity Pounds	Boom Ang. Deg.	Jib Point Elev. Feet	Jib Capacity Pounds	
100 Ft. BOOM										
40	79.8	187.9	20,600*							40
45	78.2	186.8	20,400*							45
50	76.6	185.6	20,300*							50
55	74.9	184.2	20,100*	79.4	183.1	19,600*				55
60	73.3	182.7	20,000*	77.8	181.5	19,400*				60
65	71.6	181.0	19,800*	76.1	179.9	19,000*	80.9	176.7	17,400*	65
70	70.0	179.2	19,700*	74.4	178.0	18,600*	79.1	174.8	17,100*	70
75	68.3	177.2	19,600*	72.7	176.0	18,100*	77.4	172.8	16,700*	75
80	66.6	175.0	19,200*	71.0	173.8	17,700*	75.6	170.5	16,400*	80
85	64.8	172.6	18,700*	69.3	171.4	17,400*	73.8	168.1	16,000*	85
90	63.1	170.0	18,300*	67.5	168.8	17,000*	72.0	165.4	15,700*	90
100	59.4	164.3	17,500*	63.8	163.0	16,300*	68.3	159.5	14,900*	100
110	55.7	157.7	16,700*	60.0	156.3	15,600*	64.4	152.7	13,800*	110
120	51.7	150.0	16,000*	56.0	148.6	15,000*	60.3	144.8	12,800*	120
130	47.5	141.2	15,300*	51.8	139.7	14,400*	55.9	135.6	12,000*	130
140	43.0	130.9	14,600*	47.2	129.3	13,900*	51.2	124.8	11,300*	140
150	38.1	118.8	14,000*	42.2	117.0	13,400*	46.0	111.9	10,700*	150
160	32.5	104.1	13,500*	36.5	102.0	12,600*	39.9	96.1	10,200*	160
170	25.8	85.3	13,000*	29.6	82.7	11,900*	32.5	75.1	9,800*	170
180	16.6	58.1	12,700*	20.0	53.8	11,400*				180



777T

Liftcrane Jib Capacities

Meets
ANSI B30.5
Requirements

Jib No. 134 With 12 Ft. 6 in. Strut On
Boom No. 78T With Heavy Lift Top
95,400 Lb. Crane Counterweight
25,000 Lb. Front Bumper Counterweight
360 Degree Rating On Fully Extended Outriggers

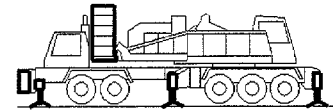

80 Ft. JIB

Jib Oper. Rad. Feet	5 Degree Offset			15 Degree Offset			25 Degree Offset			Jib Oper. Rad. Feet
	Boom Ang. Deg.	Jib Point Elev. Feet	Jib Capacity Pounds	Boom Ang. Deg.	Jib Point Elev. Feet	Jib Capacity Pounds	Boom Ang. Deg.	Jib Point Elev. Feet	Jib Capacity Pounds	
110 Ft. BOOM										
40	80.3	198.1	20,600*							40
45	78.8	197.0	20,500*							45
50	77.3	195.9	20,300*							50
55	75.7	194.6	20,200*	80.0	193.4	19,700*				55
60	74.2	193.2	20,000*	78.5	192.0	19,600*				60
65	72.6	191.6	19,900*	76.9	190.4	19,200*				65
70	71.1	189.8	19,800*	75.3	188.6	18,800*	79.8	185.4	17,200*	70
75	69.5	188.0	19,600*	73.7	186.7	18,400*	78.1	183.4	16,900*	75
80	67.9	185.9	19,500*	72.1	184.7	18,000*	76.5	181.3	16,500*	80
85	66.2	183.7	19,100*	70.4	182.4	17,600*	74.8	179.0	16,200*	85
90	64.6	181.3	18,700*	68.8	180.0	17,300*	73.1	176.6	15,900*	90
100	61.2	175.9	17,900*	65.4	174.6	16,600*	69.6	171.1	15,300*	100
110	57.7	169.8	17,100*	61.8	168.4	15,900*	66.0	164.7	14,200*	110
120	54.1	162.8	16,400*	58.2	161.3	15,300*	62.2	157.5	13,200*	120
130	50.2	154.7	15,700*	54.3	153.2	14,800*	58.3	149.1	12,400*	130
140	46.2	145.4	15,100*	50.2	143.8	14,200*	54.0	139.4	11,700*	140
150	41.8	134.7	14,500*	45.8	133.0	13,800*	49.4	128.2	11,100*	150
160	37.0	122.1	13,900*	40.9	120.1	13,200*	44.3	114.8	10,600*	160
170	31.6	106.9	13,400*	35.3	104.6	12,500*	38.5	98.3	10,100*	170
180	25.1	87.5	13,000*	28.6	84.6	11,800*	31.2	76.5	9,800*	180
190	16.2	59.4	11,700	19.2	54.9	11,300*				190



777T

Liftcrane Jib Capacities

Meets
ANSI B30.5
Requirements

Jib No. 134 With 12 Ft. 6 in. Strut On
Boom No. 78T With Heavy Lift Top
95,400 Lb. Crane Counterweight
25,000 Lb. Front Bumper Counterweight
360 Degree Rating On Fully Extended Outriggers

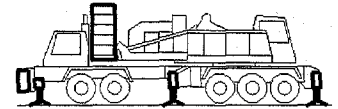

80 Ft. JIB

Jib Oper. Rad. Feet	5 Degree Offset			15 Degree Offset			25 Degree Offset			Jib Oper. Rad. Feet
	Boom Ang. Deg.	Jib Point Elev. Feet	Jib Capacity Pounds	Boom Ang. Deg.	Jib Point Elev. Feet	Jib Capacity Pounds	Boom Ang. Deg.	Jib Point Elev. Feet	Jib Capacity Pounds	
120 Ft. BOOM										
40	80.8	208.2	20,700*							40
45	79.4	207.3	20,500*							45
50	77.9	206.2	20,400*							50
55	76.5	204.9	20,300*	80.5	203.7	19,700*				55
60	75.0	203.6	20,100*	79.1	202.4	19,600*				60
65	73.5	202.1	20,000*	77.6	200.8	19,400*				65
70	72.0	200.4	19,900*	76.1	199.2	19,000*	80.3	195.8	17,300*	70
75	70.5	198.7	19,700*	74.5	197.4	18,600*	78.8	194.0	17,000*	75
80	69.0	196.7	19,600*	73.0	195.4	18,200*	77.2	192.0	16,700*	80
85	67.5	194.6	19,400*	71.5	193.3	17,900*	75.6	189.9	16,400*	85
90	65.9	192.4	19,000*	69.9	191.1	17,500*	74.0	187.6	16,100*	90
100	62.8	187.4	18,200*	66.7	186.0	16,800*	70.8	182.4	15,500*	100
110	59.5	181.6	17,500*	63.4	180.2	16,200*	67.4	176.5	14,600*	110
120	56.1	175.1	16,800*	60.0	173.7	15,600*	63.9	169.8	13,600*	120
130	52.6	167.7	16,100*	56.5	166.2	15,100*	60.3	162.1	12,800*	130
140	48.9	159.2	15,500*	52.7	157.6	14,500*	56.4	153.3	12,100*	140
150	44.9	149.5	14,900*	48.7	147.8	14,100*	52.3	143.2	11,400*	150
160	40.7	138.4	14,300*	44.4	136.5	13,600*	47.8	131.4	10,900*	160
170	36.0	125.3	13,800*	39.7	123.2	13,100*	42.9	117.5	10,400*	170
180	30.7	109.5	13,100	34.3	107.1	12,400*	37.1	100.4	10,000*	180
190	24.4	89.6	11,600	27.8	86.6	11,800*	30.0	77.9	9,700*	190
200	15.7	60.7	10,200	18.6	55.9	10,400				200



777T

Liftcrane Jib Capacities

Meets
ANSI B30.5
Requirements

Jib No. 134 With 12 Ft. 6 in. Strut On
Boom No. 78T With Heavy Lift Top
95,400 Lb. Crane Counterweight
25,000 Lb. Front Bumper Counterweight
360 Degree Rating On Fully Extended Outriggers

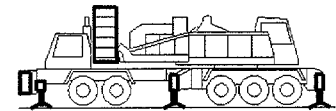

80 Ft. JIB

Jib Oper. Rad. Feet	5 Degree Offset			15 Degree Offset			25 Degree Offset			Jib Oper. Rad. Feet
	Boom Ang. Deg.	Jib Point Elev. Feet	Jib Capacity Pounds	Boom Ang. Deg.	Jib Point Elev. Feet	Jib Capacity Pounds	Boom Ang. Deg.	Jib Point Elev. Feet	Jib Capacity Pounds	
130 Ft. BOOM										
45	79.9	217.5	20,600*							45
50	78.5	216.4	20,500*							50
55	77.1	215.3	20,300*	81.0	214.0	19,700*				55
60	75.7	214.0	20,200*	79.6	212.7	19,600*				60
65	74.3	212.5	20,100*	78.2	211.3	19,500*				65
70	72.9	211.0	19,900*	76.8	209.7	19,100*	80.8	206.3	17,400*	70
75	71.5	209.3	19,800*	75.3	208.0	18,800*	79.3	204.5	17,100*	75
80	70.0	207.5	19,700*	73.9	206.2	18,400*	77.9	202.6	16,800*	80
85	68.6	205.5	19,600*	72.4	204.2	18,100*	76.4	200.6	16,500*	85
90	67.1	203.4	19,300*	70.9	202.0	17,700*	74.9	198.4	16,200*	90
100	64.1	198.6	18,600*	67.9	197.3	17,100*	71.8	193.6	15,700*	100
110	61.1	193.3	17,800*	64.8	191.8	16,500*	68.6	188.1	15,000*	110
120	57.9	187.1	17,200*	61.7	185.7	15,900*	65.4	181.8	14,000*	120
130	54.6	180.2	16,500*	58.3	178.7	15,300*	62.0	174.6	13,200*	130
140	51.2	172.4	15,900*	54.9	170.8	14,800*	58.5	166.6	12,400*	140
150	47.6	163.6	15,300*	51.2	161.9	14,400*	54.7	157.4	11,800*	150
160	43.8	153.5	14,700*	47.4	151.7	13,900*	50.7	146.8	11,200*	160
170	39.6	141.9	14,200*	43.2	140.0	13,500*	46.4	134.6	10,700*	170
180	35.1	128.4	12,600	38.6	126.2	12,900*	41.5	120.2	10,300*	180
190	30.0	112.2	11,100	33.3	109.6	11,500	35.9	102.6	10,000*	190
200	23.8	91.6	9,800	26.9	88.4	10,100	28.9	79.3	9,700*	200
210	15.3	62.0	8,600	17.9	56.9	8,700				210



Liftcrane Jib Capacities

Jib No. 134 With 12 Ft. 6 in. Strut On
 Boom No. 78T With Heavy Lift Top
 95,400 Lb. Crane Counterweight
 25,000 Lb. Front Bumper Counterweight
 360 Degree Rating On Fully Extended Outriggers

Meets
ANSI B30.5
Requirements

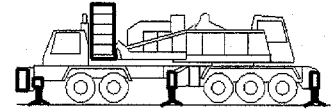

80 Ft. JIB

Jib Oper. Rad. Feet	5 Degree Offset			15 Degree Offset			25 Degree Offset			Jib Oper. Rad. Feet
	Boom Ang. Deg.	Jib Point Elev. Feet	Jib Capacity Pounds	Boom Ang. Deg.	Jib Point Elev. Feet	Jib Capacity Pounds	Boom Ang. Deg.	Jib Point Elev. Feet	Jib Capacity Pounds	
140 Ft. BOOM										
45	80.3	227.6	20,600*							45
50	79.0	226.6	20,500*							50
55	77.7	225.5	20,400*							55
60	76.4	224.3	20,300*	80.1	223.0	19,700*				60
65	75.0	223.0	20,100*	78.7	221.7	19,600*				65
70	73.7	221.5	20,000*	77.4	220.2	19,300*				70
75	72.3	219.9	19,900*	76.0	218.5	19,000*	79.8	215.0	17,200*	75
80	71.0	218.1	19,800*	74.6	216.8	18,600*	78.4	213.2	16,900*	80
85	69.6	216.3	19,700*	73.3	214.9	18,300*	77.0	211.3	16,600*	85
90	68.2	214.2	19,600*	71.9	212.9	17,900*	75.6	209.2	16,400*	90
100	65.4	209.8	18,900*	69.0	208.4	17,300*	72.7	204.6	15,800*	100
110	62.5	204.7	18,200*	66.1	203.3	16,700*	69.8	199.4	15,300*	110
120	59.5	199.0	17,500*	63.1	197.5	16,100*	66.7	193.5	14,400*	120
130	56.5	192.5	16,900*	60.0	191.0	15,600*	63.5	186.9	13,500*	130
140	53.3	185.2	16,200*	56.8	183.7	15,100*	60.2	179.4	12,800*	140
150	49.9	177.1	15,700*	53.4	175.4	14,600*	56.8	170.9	12,100*	150
160	46.4	167.8	15,100*	49.9	166.1	14,200*	53.1	161.3	11,600*	160
170	42.7	157.4	13,800	46.1	155.5	13,800*	49.2	150.4	11,100*	170
180	38.7	145.4	12,200	42.0	143.4	12,700	45.0	137.7	10,600*	180
190	34.3	131.4	10,700	37.5	129.2	11,200	40.3	122.8	10,200*	190
200	29.2	114.7	9,400	32.4	112.1	9,800	34.8	104.6	9,900*	200
210	23.2	93.6	8,200	26.2	90.3	8,400	28.0	80.6	8,600	210
220	15.0	63.3	7,000	17.4	57.9	7,200				220



777T

Liftcrane Jib Capacities

Jib No. 134 With 12 Ft. 6 in. Strut On
Boom No. 78T With Heavy Lift Top
95,400 Lb. Crane Counterweight
25,000 Lb. Front Bumper Counterweight
360 Degree Rating On Fully Extended Outriggers

Meets
ANSI B30.5
Requirements

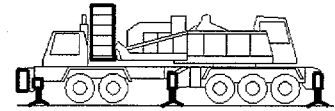

80 Ft. JIB

Jib Oper. Rad. Feet	5 Degree Offset			15 Degree Offset			25 Degree Offset			Jib Oper. Rad. Feet
	Boom Ang. Deg.	Jib Point Elev. Feet	Jib Capacity Pounds	Boom Ang. Deg.	Jib Point Elev. Feet	Jib Capacity Pounds	Boom Ang. Deg.	Jib Point Elev. Feet	Jib Capacity Pounds	
150 Ft. BOOM										
45	80.8	237.8	20,700*							45
50	79.5	236.9	20,600*							50
55	78.2	235.8	20,400*							55
60	77.0	234.6	20,300*	80.5	233.3	19,700*				60
65	75.7	233.3	20,200*	79.2	232.0	19,600*				65
70	74.4	231.9	20,100*	77.9	230.6	19,500*				70
75	73.1	230.4	20,000*	76.6	229.0	19,100*	80.3	225.4	17,300*	75
80	71.8	228.7	19,800*	75.3	227.4	18,800*	79.0	223.7	17,000*	80
85	70.5	226.9	19,700*	74.0	225.6	18,500*	77.6	221.9	16,700*	85
90	69.2	225.0	19,600*	72.7	223.7	18,100*	76.3	219.9	16,500*	90
100	66.5	220.8	19,200*	70.0	219.4	17,500*	73.5	215.6	16,000*	100
110	63.8	216.0	18,500*	67.2	214.5	17,000*	70.7	210.7	15,500*	110
120	61.0	210.6	17,800*	64.4	209.1	16,400*	67.9	205.1	14,700*	120
130	58.1	204.5	17,200*	61.5	203.0	15,900*	64.9	198.9	13,900*	130
140	55.1	197.7	16,600*	58.5	196.1	15,400*	61.8	191.8	13,100*	140
150	52.0	190.1	16,000*	55.4	188.4	14,900*	58.6	184.0	12,500*	150
160	48.8	181.6	15,000	52.1	179.8	14,500*	55.2	175.1	11,900*	160
170	45.4	172.0	13,200	48.6	170.2	13,900	51.7	165.2	11,400*	170
180	41.7	161.2	11,500	45.0	159.2	12,200	47.9	153.8	10,900*	180
190	37.8	148.8	10,000	41.0	146.6	10,600	43.7	140.8	10,500*	190
200	33.5	134.4	8,700	36.6	132.0	9,200	39.1	125.4	9,600	200
210	28.6	117.2	7,500	31.6	114.4	7,900	33.8	106.7	8,200	210
220	22.7	95.6	6,400	25.5	92.1	6,700	27.1	81.9	6,800	220
230	14.6	64.5	5,400	16.9	58.8	5,500				230



Liftcrane Jib Capacities

Jib No. 134 With 12 Ft. 6 in. Strut On
 Boom No. 78T With Heavy Lift Top
 95,400 Lb. Crane Counterweight
 25,000 Lb. Front Bumper Counterweight
 360 Degree Rating On Fully Extended Outriggers

Meets
ANSI B30.5
Requirements

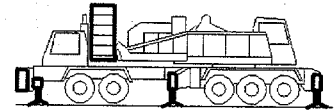

80 Ft. JIB

Jib Oper. Rad. Feet	5 Degree Offset			15 Degree Offset			25 Degree Offset			Jib Oper. Rad. Feet
	Boom Ang. Deg.	Jib Point Elev. Feet	Jib Capacity Pounds	Boom Ang. Deg.	Jib Point Elev. Feet	Jib Capacity Pounds	Boom Ang. Deg.	Jib Point Elev. Feet	Jib Capacity Pounds	
160 Ft. BOOM										
50	79.9	247.0	20,600*							50
55	78.7	246.0	20,500*							55
60	77.5	244.9	20,400*	80.9	243.6	19,700*				60
65	76.3	243.7	20,200*	79.7	242.3	19,600*				65
70	75.1	242.3	20,100*	78.5	241.0	19,600*				70
75	73.9	240.9	20,000*	77.2	239.5	19,300*	80.7	235.8	17,400*	75
80	72.6	239.3	19,900*	76.0	237.9	18,900*	79.5	234.2	17,100*	80
85	71.4	237.6	19,800*	74.7	236.2	18,600*	78.2	232.5	16,900*	85
90	70.1	235.8	19,700*	73.4	234.4	18,300*	76.9	230.6	16,600*	90
100	67.6	231.7	19,500*	70.9	230.3	17,700*	74.3	226.5	16,100*	100
110	65.0	227.2	18,800*	68.3	225.7	17,200*	71.6	221.8	15,600*	110
120	62.3	222.0	18,100*	65.6	220.5	16,600*	68.9	216.5	15,000*	120
130	59.6	216.3	17,500*	62.8	214.7	16,100*	66.1	210.6	14,200*	130
140	56.8	209.9	16,900*	60.0	208.3	15,600*	63.2	204.0	13,500*	140
150	53.9	202.8	16,400*	57.1	201.1	15,100*	60.2	196.7	12,800*	150
160	50.8	194.8	14,600	54.0	193.1	14,300*	57.1	188.5	12,200*	160
170	47.7	186.0	12,700	50.8	184.2	12,800*	53.8	179.3	11,700*	170
180	44.3	176.0	11,000	47.5	174.1	11,600*	50.3	168.9	11,200*	180
190	40.8	164.8	9,600	43.9	162.8	10,200	46.6	157.2	10,200*	190
200	37.0	152.1	8,300	40.0	149.9	8,800	42.6	143.7	9,200*	200
210	32.7	137.3	7,100	35.7	134.8	7,500	38.1	127.9	7,900	210
220	27.9	119.7	6,000	30.8	116.8	6,300	32.8	108.6	6,600	220
230	22.2	97.5	5,000	24.8	93.8	5,200	26.2	83.2	5,400	230
240	14.3	65.7	4,000	16.4	59.8	4,100				240



777T

Liftcrane Jib Capacities

Jib No. 134 With 12 Ft. 6 in. Strut On
Boom No. 78T With Heavy Lift Top
95,400 Lb. Crane Counterweight
25,000 Lb. Front Bumper Counterweight
360 Degree Rating On Fully Extended Outriggers

Meets
ANSI B30.5
Requirements

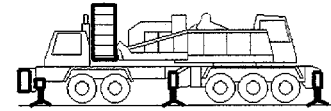

80 Ft. JIB

Jib Oper. Rad. Feet	5 Degree Offset			15 Degree Offset			25 Degree Offset			Jib Oper. Rad. Feet
	Boom Ang. Deg.	Jib Point Elev. Feet	Jib Capacity Pounds	Boom Ang. Deg.	Jib Point Elev. Feet	Jib Capacity Pounds	Boom Ang. Deg.	Jib Point Elev. Feet	Jib Capacity Pounds	
170 Ft. BOOM										
50	80.4	257.2	20,600*							50
55	79.2	256.2	20,500*							55
60	78.0	255.2	20,400*							60
65	76.9	254.0	20,300*	80.1	252.6	19,700*				65
70	75.7	252.7	20,200*	78.9	251.3	19,600*				70
75	74.5	251.3	20,100*	77.7	249.9	19,400*				75
80	73.3	249.8	20,000*	76.6	248.4	19,100*	79.9	244.6	17,200*	80
85	72.1	248.2	19,900*	75.4	246.7	18,800*	78.7	243.0	17,000*	85
90	70.9	246.4	19,800*	74.1	245.0	18,500*	77.5	241.2	16,700*	90
100	68.5	242.6	19,600*	71.7	241.1	17,900*	75.0	237.2	16,200*	100
110	66.0	238.2	19,100*	69.2	236.7	17,300*	72.4	232.8	15,800*	110
120	63.5	233.3	18,400*	66.7	231.8	16,800*	69.9	227.8	15,300*	120
130	60.9	227.9	17,800*	64.1	226.4	16,300*	67.2	222.2	14,500*	130
140	58.3	221.8	17,200*	61.4	220.3	15,800*	64.5	216.0	13,800*	140
150	55.5	215.1	15,400*	58.6	213.5	14,600*	61.7	209.1	13,100*	150
160	52.7	207.7	13,800*	55.8	206.0	13,100*	58.7	201.4	12,400*	160
170	49.7	199.4	12,300*	52.8	197.7	11,700*	55.7	192.9	11,200*	170
180	46.7	190.2	10,800	49.7	188.4	10,500*	52.5	183.3	10,100*	180
190	43.4	180.0	9,300	46.4	178.0	9,400*	49.1	172.6	9,100*	190
200	39.9	168.4	8,000	42.9	166.3	8,400*	45.5	160.5	8,200*	200
210	36.2	155.3	6,800	39.1	153.0	7,300	41.5	146.7	7,300*	210
220	32.1	140.1	5,700	34.9	137.5	6,200	37.1	130.4	6,500	220
230	27.4	122.0	4,700	30.1	119.0	5,100	31.9	110.6	5,300	230
240	21.7	99.4	3,800	24.2	95.6	4,100	25.5	84.5	4,200	240
250	14.0	66.8	2,900	16.0	60.7	3,100				250



Liftcrane Jib Capacities

Meets
ANSI B30.5
Requirements

Jib No. 134 With 12 Ft. 6 in. Strut On
Boom No. 78T With Heavy Lift Top
95,400 Lb. Crane Counterweight
25,000 Lb. Front Bumper Counterweight
360 Degree Rating On Fully Extended Outriggers

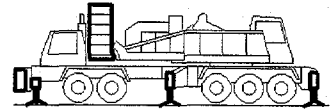

80 Ft. JIB

Jib Oper. Rad. Feet	5 Degree Offset			15 Degree Offset			25 Degree Offset			Jib Oper. Rad. Feet
	Boom Ang. Deg.	Jib Point Elev. Feet	Jib Capacity Pounds	Boom Ang. Deg.	Jib Point Elev. Feet	Jib Capacity Pounds	Boom Ang. Deg.	Jib Point Elev. Feet	Jib Capacity Pounds	
180 Ft. BOOM										
50	80.7	267.4	20,700*							50
55	79.6	266.4	20,600*							55
60	78.5	265.4	20,500*							60
65	77.4	264.3	20,400*	80.5	262.9	19,700*				65
70	76.3	263.0	20,200*	79.4	261.6	19,600*				70
75	75.1	261.7	20,100*	78.2	260.3	19,500*				75
80	74.0	260.2	20,000*	77.1	258.8	19,200*	80.3	255.0	17,300*	80
85	72.8	258.7	19,900*	75.9	257.3	18,900*	79.2	253.4	17,000*	85
90	71.7	257.0	19,800*	74.8	255.6	18,600*	78.0	251.7	16,800*	90
100	69.4	253.3	19,600*	72.4	251.9	18,100*	75.6	247.9	16,300*	100
110	67.0	249.2	19,300*	70.1	247.7	17,500*	73.2	243.7	15,900*	110
120	64.6	244.5	18,700*	67.6	243.0	17,000*	70.7	238.9	15,500*	120
130	62.1	239.3	18,100*	65.2	237.8	16,500*	68.2	233.6	14,800*	130
140	59.6	233.6	17,500*	62.6	232.0	16,100*	65.6	227.7	14,100*	140
150	57.0	227.3	15,700*	60.0	225.6	14,800*	62.9	221.2	13,400*	150
160	54.3	220.2	13,800	57.3	218.6	13,200*	60.2	214.0	12,500*	160
170	51.6	212.5	11,900	54.5	210.7	11,800*	57.3	206.0	11,200*	170
180	48.7	203.9	10,300	51.6	202.1	10,600*	54.4	197.1	10,100*	180
190	45.7	194.4	8,800	48.6	192.5	9,400*	51.2	187.3	9,100*	190
200	42.5	183.8	7,500	45.4	181.8	8,100	47.9	176.2	8,100*	200
210	39.1	172.0	6,300	41.9	169.8	6,900	44.4	163.8	7,300*	210
220	35.5	158.5	5,200	38.2	156.1	5,700	40.5	149.5	6,100	220
230	31.4	142.9	4,200	34.1	140.2	4,700	36.1	132.8	5,000	230
240	26.8	124.4	3,300	29.4	121.3	3,700	31.1	112.5	3,900	240
250	21.3	101.2	2,500	23.7	97.2	2,700	24.8	85.8	2,800	250



777T

Liftcrane Jib Capacities

Jib No. 134 With 12 Ft. 6 in. Strut On
Boom No. 78T With Heavy Lift Top
95,400 Lb. Crane Counterweight
25,000 Lb. Front Bumper Counterweight
360 Degree Rating On Fully Extended Outriggers

Meets
ANSI B30.5
Requirements

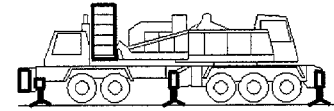

80 Ft. JIB

Jib Oper. Rad. Feet	5 Degree Offset			15 Degree Offset			25 Degree Offset			Jib Oper. Rad. Feet
	Boom Ang. Deg.	Jib Point Elev. Feet	Jib Capacity Pounds	Boom Ang. Deg.	Jib Point Elev. Feet	Jib Capacity Pounds	Boom Ang. Deg.	Jib Point Elev. Feet	Jib Capacity Pounds	
190 Ft. BOOM										
55	80.0	276.6	20,600*							55
60	78.9	275.6	20,500*							60
65	77.8	274.5	20,400*	80.9	273.1	19,700*				65
70	76.8	273.4	20,300*	79.8	271.9	19,700*				70
75	75.7	272.1	20,200*	78.7	270.6	19,600*				75
80	74.6	270.7	20,100*	77.6	269.2	19,400*	80.7	265.4	17,400*	80
85	73.5	269.2	20,000*	76.5	267.7	19,100*	79.6	263.8	17,100*	85
90	72.4	267.6	19,900*	75.4	266.1	18,800*	78.5	262.2	16,900*	90
100	70.2	264.0	19,700*	73.1	262.6	18,200*	76.2	258.6	16,400*	100
110	67.9	260.1	19,500*	70.8	258.6	17,700*	73.9	254.5	16,000*	110
120	65.6	255.6	19,000*	68.5	254.1	17,200*	71.5	250.0	15,600*	120
130	63.2	250.7	18,400*	66.2	249.1	16,700*	69.1	244.9	15,100*	130
140	60.8	245.2	17,800*	63.7	243.6	16,300*	66.6	239.3	14,400*	140
150	58.4	239.2	15,400	61.3	237.5	15,000*	64.1	233.1	13,700*	150
160	55.9	232.5	13,300	58.7	230.9	13,400*	61.5	226.3	12,600*	160
170	53.3	225.2	11,500	56.1	223.5	12,000*	58.8	218.8	11,300*	170
180	50.6	217.2	9,800	53.4	215.4	10,700	56.1	210.5	10,200*	180
190	47.7	208.3	8,300	50.5	206.4	9,100	53.1	201.3	9,100*	190
200	44.8	198.5	7,000	47.6	196.5	7,700	50.1	191.1	8,200*	200
210	41.7	187.6	5,800	44.4	185.5	6,500	46.8	179.8	7,000	210
220	38.4	175.4	4,800	41.0	173.1	5,300	43.3	166.9	5,800	220
230	34.8	161.6	3,800	37.4	159.1	4,300	39.5	152.3	4,700	230
240	30.8	145.6	2,900	33.4	142.8	3,300	35.3	135.2	3,600	240
250	26.3	126.7	2,000	28.7	123.4	2,300	30.3	114.4	2,600	250



777T

Liftcrane Jib Capacities

Jib No. 134 With 12 Ft. 6 in. Strut On
Boom No. 78T With Heavy Lift Top
95,400 Lb. Crane Counterweight
25,000 Lb. Front Bumper Counterweight
360 Degree Rating On Fully Extended Outriggers

Meets
ANSI B30.5
Requirements

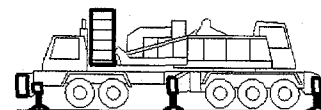

80 Ft. JIB

Jib Oper. Rad. Feet	5 Degree Offset			15 Degree Offset			25 Degree Offset			Jib Oper. Rad. Feet
	Boom Ang. Deg.	Jib Point Elev. Feet	Jib Capacity Pounds	Boom Ang. Deg.	Jib Point Elev. Feet	Jib Capacity Pounds	Boom Ang. Deg.	Jib Point Elev. Feet	Jib Capacity Pounds	
200 Ft. BOOM										
55	80.4	286.8	20,700*							55
60	79.3	285.8	20,600*							60
65	78.3	284.8	20,500*							65
70	77.2	283.6	20,400*	80.1	282.2	19,700*				70
75	76.2	282.4	20,300*	79.1	281.0	19,600*				75
80	75.1	281.1	20,200*	78.0	279.6	19,500*				80
85	74.1	279.6	20,100*	77.0	278.2	19,200*	80.0	274.2	17,200*	85
90	73.0	278.1	20,000*	75.9	276.6	18,900*	78.9	272.7	17,000*	90
100	70.9	274.7	19,800*	73.8	273.2	18,400*	76.7	269.2	16,600*	100
110	68.7	270.9	19,600*	71.6	269.4	17,900*	74.5	265.3	16,100*	110
120	66.5	266.6	19,200*	69.3	265.1	17,400*	72.2	261.0	15,700*	120
130	64.3	261.9	18,700*	67.1	260.3	16,900*	69.9	256.1	15,400*	130
140	62.0	256.7	17,400	64.8	255.1	16,500*	67.6	250.8	14,600*	140
150	59.6	250.9	15,000	62.4	249.3	15,100*	65.2	244.9	14,000*	150
160	57.2	244.6	12,800	60.0	242.9	13,500*	62.7	238.4	12,600*	160
170	54.8	237.7	10,900	57.5	236.0	11,800*	60.2	231.3	11,200*	170
180	52.2	230.1	9,300	55.0	228.3	10,200	57.6	223.5	9,800*	180
190	49.6	221.8	7,800	52.3	219.9	8,700	54.8	214.9	8,400*	190
200	46.8	212.6	6,500	49.5	210.7	7,300	52.0	205.4	7,200*	200
210	43.9	202.5	5,300	46.6	200.5	6,000	49.0	194.9	6,100*	210
220	40.9	191.3	4,200	43.5	189.1	4,900	45.8	183.2	5,000*	220
230	37.6	178.8	3,300	40.2	176.4	3,800	42.4	170.0	4,100*	230
240	34.1	164.6	2,400	36.6	162.0	2,800	38.7	155.0	3,200	240
250							34.5	137.5	2,200	250



777T

Liftcrane Jib Capacities

Jib No. 134 With 12 Ft. 6 in. Strut On
 Boom No. 78T With Heavy Lift Top
 95,400 Lb. Crane Counterweight
 25,000 Lb. Front Bumper Counterweight
 360 Degree Rating On Fully Extended Outriggers

Meets
 ANSI B30.5
 Requirements

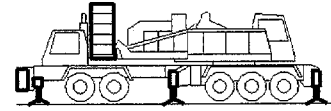

80 Ft. JIB

Jib Oper. Rad. Feet	5 Degree Offset			15 Degree Offset			25 Degree Offset			Jib Oper. Rad. Feet
	Boom Ang. Deg.	Jib Point Elev. Feet	Jib Capacity Pounds	Boom Ang. Deg.	Jib Point Elev. Feet	Jib Capacity Pounds	Boom Ang. Deg.	Jib Point Elev. Feet	Jib Capacity Pounds	
210 Ft. BOOM										
55	80.7	297.0	20,700*							55
60	79.7	296.0	20,600*							60
65	78.7	295.0	20,500*							65
70	77.7	293.9	20,400*	80.5	292.5	19,700*				70
75	76.7	292.7	20,300*	79.5	291.3	19,600*				75
80	75.7	291.4	20,200*	78.5	290.0	19,500*				80
85	74.7	290.0	20,100*	77.4	288.6	19,300*	80.3	284.6	17,300*	85
90	73.6	288.6	20,000*	76.4	287.1	19,000*	79.3	283.1	17,000*	90
100	71.6	285.3	19,800*	74.3	283.8	18,500*	77.2	279.8	16,600*	100
110	69.5	281.6	19,600*	72.2	280.1	18,000*	75.1	276.0	16,200*	110
120	67.4	277.5	19,400*	70.1	276.0	17,500*	72.9	271.8	15,800*	120
130	65.2	273.0	17,900*	67.9	271.4	16,200*	70.7	267.2	14,800*	130
140	63.0	268.0	15,700*	65.7	266.4	14,300*	68.5	262.1	13,100*	140
150	60.8	262.5	13,700*	63.5	260.9	12,600*	66.2	256.5	11,600*	150
160	58.5	256.5	12,000*	61.2	254.8	11,100*	63.8	250.3	10,300*	160
170	56.1	249.9	10,500*	58.8	248.2	9,800*	61.4	243.6	9,100*	170
180	53.7	242.7	8,900	56.4	241.0	8,600*	58.9	236.2	8,100*	180
190	51.2	234.9	7,400	53.9	233.0	7,500*	56.4	228.1	7,100*	190
200	48.7	226.3	6,100	51.3	224.4	6,600*	53.7	219.2	6,200*	200
210	46.0	216.8	4,900	48.5	214.8	5,700	50.9	209.4	5,400*	210
220	43.1	206.4	3,900	45.7	204.3	4,500	48.0	198.6	4,700*	220
230	40.1	194.9	2,900	42.7	192.7	3,500	44.8	186.6	4,000	230
240	36.9	182.1	2,000	39.4	179.7	2,500	41.5	173.1	2,900	240
250							37.8	157.7	2,000	250



Liftcrane Jib Capacities

Jib No. 134 With 12 Ft. 6 in. Strut On
 Boom No. 78T With Heavy Lift Top
 95,400 Lb. Crane Counterweight
 25,000 Lb. Front Bumper Counterweight
 360 Degree Rating On Fully Extended Outriggers

Meets
ANSI B30.5
Requirements

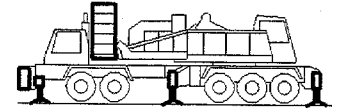

80 Ft. JIB

Jib Oper. Rad. Feet	5 Degree Offset			15 Degree Offset			25 Degree Offset			Jib Oper. Rad. Feet
	Boom Ang. Deg.	Jib Point Elev. Feet	Jib Capacity Pounds	Boom Ang. Deg.	Jib Point Elev. Feet	Jib Capacity Pounds	Boom Ang. Deg.	Jib Point Elev. Feet	Jib Capacity Pounds	
220 Ft. BOOM										
55	81.0	307.1	22,000*							55
60	80.0	306.2	21,800*							60
65	79.1	305.2	21,700*							65
70	78.1	304.2	21,600*	80.8	302.7	20,600*				70
75	77.1	303.0	21,400*	79.8	301.5	20,500*				75
80	76.2	301.8	21,300*	78.9	300.3	20,500*				80
85	75.2	300.4	21,100*	77.9	298.9	20,400*	80.7	294.9	18,300*	85
90	74.2	299.0	21,000*	76.9	297.5	20,300*	79.7	293.5	18,100*	90
100	72.2	295.9	20,700*	74.9	294.3	19,700*	77.6	290.3	17,600*	100
110	70.2	292.3	20,400*	72.9	290.8	19,200*	75.6	286.7	17,200*	110
120	68.2	288.4	19,800*	70.8	286.8	18,100*	73.5	282.7	16,300*	120
130	66.1	284.0	17,600*	68.7	282.5	15,900*	71.4	278.2	14,500*	130
140	64.0	279.3	15,500*	66.6	277.6	14,100*	69.3	273.3	12,900*	140
150	61.8	274.0	13,600*	64.5	272.4	12,400*	67.1	267.9	11,500*	150
160	59.7	268.3	11,900*	62.3	266.6	11,000*	64.8	262.1	10,200*	160
170	57.4	262.0	10,200	60.0	260.3	9,700*	62.5	255.6	9,000*	170
180	55.1	255.1	8,600	57.7	253.4	8,500*	60.2	248.6	8,000*	180
190	52.8	247.7	7,100	55.3	245.9	7,500*	57.7	240.9	7,000*	190
200	50.3	239.6	5,800	52.9	237.7	6,600*	55.2	232.6	6,200*	200
210	47.8	230.7	4,600	50.3	228.7	5,400	52.6	223.4	5,400*	210
220	45.1	221.0	3,600	47.6	218.9	4,300	49.9	213.4	4,900	220
230	42.4	210.3	2,600	44.8	208.1	3,200	47.0	202.3	3,800	230
240				41.9	196.2	2,200	43.9	189.9	2,700	240