

GMK4115

product guide

features

- 115-ton (100 mt) capacity
- 37-171 ft. (11.3-52 m) 6 section full power Mega Form boom with Twin Lock pinning
- 33-56 ft. (10-17 m) hydraulic offset bi-fold swingaway
- 2 X 16 ft. (5 m) intermediate lattice inserts
- 57,500 lb. (26.1 t) counterweight with hydraulic removal system
- Chassis engine: Mercedes-Benz OM 460 LA, 396 hp (295 kW), torque 1401 ft./lb. (1900 Nm)
- Superstructure engine: Mercedes-Benz OM 904 LA, 148 hp (110 kW), torque 428 ft./lb. (580 Nm)
- MEGATRAK™ independent hydro-pneumatic suspension

contents

Features	2
Specifications	3
Dimensions	5
Travel Proposal	6
Counterweight Dimensions	7
Working Range Main Boom	8
Load Charts	9
Working Range Hydraulic Offset Swingaway	12
Hydraulic Offset Swingaway Charts	14
Working Range Manual Offset Swingaway	20
Manual Offset Swingaway Charts	22



All Terrain Crane

features

2

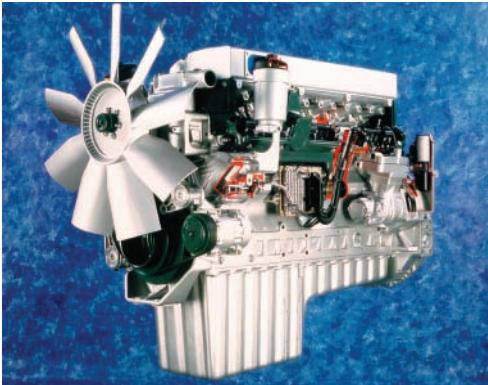

Mercedes-Benz OM460 LA
396 bhp (295 kW) @ 1800 rpm
1401 ft./lb. torque (1900 Nm) @ 1200 rpm



SUPERSTRUCTURE CAB
Hydraulically offsets to 20°; all aluminum construction

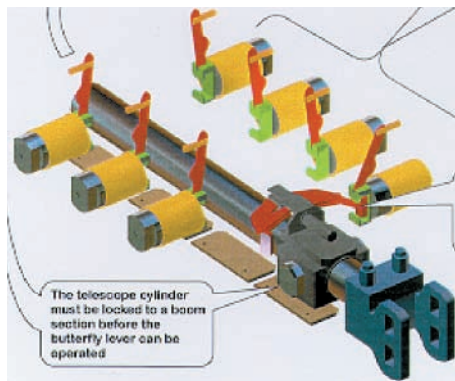

TWIN-LOCK™
Boom pinning mechanism automatically pins the sections in position using two horizontal large diameter boom pins



MEGATRAK™
Independent suspension and all-wheel steer system allows wheels to remain on the ground at all times so stresses and weight are not continually transferred between axles.

LUFFING BI-FOLD SWINGAWAY
Hydraulically offset lattice bi-fold swingaway lets the operator set the offset from 0-40° while under load from the superstructure cab



specifications

3

Superstructure



Boom

37 ft. - 171 ft. (11.3 m - 52 m) 6 section, full power Mega Form boom with Twin Lock pinning.

Maximum tip height: 180 ft. (54.7 m)



Boom Nose

Seven nylatron sheaves, mounted on heavy duty tapered roller bearings with removable pin-type rope guards. Quick reeve boom nose. Removable auxiliary boom nose with removable pin type rope guard.



Boom Elevation

Single lift cylinder with safety valve provides boom angle from -1.5° to +82°.



Hydraulic Offsettable Lattice Extension

33 ft. - 56 ft. (10 - 17 m) bi-fold lattice swingaway extension, hydraulically offsettable and luffing under load, 0° - 40°.

Maximum tip height: 235 ft (71.7 m)



*Offsettable Lattice Extension

33 ft. - 56 ft. (10 - 17 m) bifold lattice swingaway extension, manually offsettable at 0°, 20° and 40°.

Maximum tip height: 235 ft. (71.7 m)



* Lattice Extension

Two 16 ft. (5 m) inserts for use with lattice swingaway extension to increase length to 72 ft. (22 m) or 89 ft. (27 m). Maximum tip height: 268 ft (81.7m)



Load Moment & Anti-Two Block System

Load moment and anti-two block system with audio/visual warning and control lever lockout provides electronic display of boom angle, length, radius, tip height, relative load moment, maximum permissible load, load indication and warning of impending two-block condition.



Cab

All aluminum constructed cab with acoustical lining, hydraulic tilted to 20°. Includes tinted safety glass, adjustable operator's seat with hydraulic suspension, opening windows at side and rear, hinged windshield with wiper, sun visor and window shade. Other features include hot water heater/defroster, armrest integrated crane controls, drive/steer controls and ergonomically arranged instrumentation.



Crane Control System

Full electronic control of all crane movements using electrical control levers with automatic reset to zero. Controls are integrated with the LMI and engine management system by CAN-BUS. ECOS system with graphic display.



Swing

2 axial piston planetary gear boxes with fixed displacement motors. Infinitely variable to 1.9 rpm. Free swing with holding (rocker switch) and service (foot pedal) brake.



Counterweight

57,500 lbs. (26.1 t) consisting of various sections with hydraulic installation/removal system controlled from the superstructure cab.



Engine

Mercedes-Benz OM 904 LA direct injected, after cooled with 148 bhp (110 kW) @ 2200 rpm.

Max torque: 428 ft./lb. (580 Nm) @ 1200 rpm.

Engine emission: EUROMOT/EPA/CARB (non road)



Fuel Tank

Integrated in carrier fuel tank.



Hydraulic System

2 separate circuits, 1 axial piston variable displacement pump (load sensing) with electronic power limiting control and 1 gear pump for swing.

Thermostatically controlled oil coolers keep oil at optimum operating temperature.

Tank capacity: 158 gal. (600 l)



Hoist

Main and auxiliary hoist are powered by axial piston motor with planetary gear and multiple disc brake. "Thumb-thumper" hoist drum rotation indicator alerts operator of hoist movement.

	Main	Auxiliary
Line length:	837 ft. (255 m)	837 ft. (255 m)
Rope diameter:	17 mm	17 mm
Line speed:	394 ft./min. (120 m/min)	394 ft./min. (120 m/min)
Line pull:	12,589 lb. (56 kN)	12,589 lb. (56 kN)



Electrical System

24V system with three phase alternator, 28V/80A.

2 batteries 12V/170 Ah.

*Optional Equipment

- *Base boom mounted work lights
- *Boom mounted aircraft warning light
- *Stainless steel exhaust system with spark arrestor
- *Diesel heater, also serves as engine preheater
- *24 hour timer for preheater
- *Propane heater
- *Additional worklight for superstructure cab
- *Stereo radio/CD player
- *Air conditioning

*Denotes optional equipment

GMK4115

GROVE

specifications

1

Carrier

Chassis

Box type, torsion resistant frame is fabricated from high strength steel.

Outrigger System

Four hydraulic single stage outrigger beams with vertical cylinders and outrigger pads, 19.7" (500 mm) square .

Outrigger can be set in 5 positions:

Full	- 23' (7 m)
Partial	- 19.6' (6 m)
Partial	- 16.4' (5 m)
Partial	- 13.2' (4 m)
Retracted	- 8.4' (2.6 m)

Independent horizontal and vertical movement controlled from each side of carrier and the superstructure cab. Electronic crane level indicators.

Engine

Mercedes-Benz OM 460 LA direct injected with 396 bhp (295 kW) @ 1800 rpm.

Max torque: 1401 ft./lb. (1900 Nm) @ 1300 rpm.

Engine emission: EUROMOT/EPA/CARB (non road)

Fuel Tank Capacity

106 gallons (400 L). Supplies superstructure and carrier engines.

Transmission

Daimler Chrysler, G240-16

16 forward and 2 reverse speeds

2 speed transfer case

Drive/Steer

8x6x8

Axles

1st axle line – drive/steer

2nd axle line – steer/(optional drive)

3rd axle line – drive/steer (connects for all-wheel steer)

4th axle line – drive/steer

Drive axles with planetary hub reduction and center mounted gearing. Standard inter-axle and cross axle differential locks.

Suspension

Grove exclusive MEGATRAK suspension. Independent hydro-pneumatic system acting on all wheels with hydraulic lockout. Suspension can be raised 6.7" (170 mm) or lowered 5.1" (130 mm), both longitudinally and transversely. Features an automatic leveling system for highway travel.

Tires

8 tires, 16.00R25 (Vehicle width – 9.0' [2.75 m])

Steering

Dual circuit, hydraulic power assisted steering system. Transfer case mounted, ground driven emergency steering pump. Axles 1, 2, and 4 steer on highway. Separate steering of the 3rd and 4th axles for all wheel and crab steering, controlled by an electronic rocker switch.

Brakes

Service brakes: pneumatic dual circuit acting on all wheels.

Parking brake: pneumatically operated spring loaded brake acting on axle lines 2 and 4.

Standard anti-lock prevention (ABS).

Air dryer.

Cab

Two-man, aluminum construction with the following features: safety glass, driver and passenger seats with hydraulic suspension, engine-independent diesel heater/preheater with 24 hr. timer, power windows, heated rear view mirrors, complete instrumentation and driving controls.

ECOS control of suspension, drive connect and disconnect, inter-axle locks, differential locks and all-wheel steer.

Electrical System

24V system with three phase alternator, 28V/100A

2 batteries, 12V/170 Ah

Maximum Speed

53 mph (85 kph)

Gradeability (Theoretical)

63.7% - 14.00 tires

56.7% - 16.00/20.5 tires

Miscellaneous Standard Equipment

Work light; tool kit; fire extinguisher; auxiliary boom nose; radio /CD player in carrier cab, heated rear view mirrors, wind speed indicator.

Optional Equipment

- *Stainless steel exhaust system with spark arrestor
- *14.00R25 tires (vehicle width 9.0 ft.[2.75 m])
- *20.5R25 tires (vehicle width 9.8 ft.[2.88 m])
- *Spare tire and wheel with carry bracket
- *8x8x8 drive/steer (additional drive, axle #2)
- *Electric driveline retarder
- *Steel outrigger pads
- *Outrigger pad load indicator
- *Trailer and towing hitches
- *Engine independent diesel cab heater, with engine pre-heater
- *Timer for diesel heater
- *Air conditioning
- *Additional strobe lights
- *Work lights for outriggers
- *Working range limiter
- *Wireless remote control for all crane functions
- *Data logger
- *Rear mounted stowage box

**Denotes optional equipment*

GMK4115

GROVE

load charts

2

171 ft.
(52 m)

32.8-55.8-72.2-88.6 ft
(10-17-22-27 m)
Hydraulic Luffing
Loads Luffing

42,900 lbs.
(19 459 kg)

100%
23' spread

360°



Pounds x1000

Radius	170.6' + 32.8'		170.6' + 55.8'		170.6' + 72.2'		170.6' + 88.6'	
	0°-20°	20°-40°	0°-20°	20°-40°	0°-20°	20°-40°	0°-20°	20°-40°
35								
40	10.8							
45	10.8							
50	10.8	9.4						
55	10.8	9.4	7.2					
60	10.8	9.4	7.2		5.8			
65	10.8	9.4	7.2		5.8			
70	10.8	9.4	7.2	6.0	5.8		4.0	
75	10.8	9.4	7.2	6.0	5.8	5.2	4.0	
80	10.4	9.4	7.2	6.0	5.8	5.2	4.0	4.0
85	10.0	9.4	7.0	6.0	5.8	5.2	4.0	4.0
90	9.6	9.4	6.8	5.8	5.8	5.2	4.0	4.0
95	9.2	9.2	6.6	5.8	5.8	5.2	4.0	4.0
100	8.2	8.8	6.4	5.6	5.8	5.2	4.0	4.0
105	7.4	8.0	6.2	5.6	5.8	5.2	4.0	4.0
110	6.6	7.2	6.0	5.4	5.6	5.2	4.0	4.0
115	5.8	6.4	6.0	5.4	5.4	5.2	4.0	4.0
120	5.2	5.6	5.6	5.4	5.2	5.2	4.0	4.0
125	4.6	5.0	5.0	5.2	4.6	5.0	4.0	4.0
130	4.0	4.4	4.4	5.2	4.0	4.8	3.8	4.0
135	3.4	3.8	3.8	4.6	3.6	4.4	3.4	3.8
140	2.8	3.2	3.4	4.0	3.0	3.8	3.0	3.8
145	2.4	2.8	3.0	3.6	2.6	3.4	2.6	3.2
150	2.0	2.2	2.4	3.2	2.2	3.0	2.2	2.8
155	1.6	1.8	2.0	2.6	1.8	2.6	1.8	2.4
160			1.6	2.2		2.2		2.0
165				1.8		1.6		1.6
170								

GMK4115

THIS CHART IS ONLY A GUIDE AND SHOULD NOT BE USED TO OPERATE THE CRANE. The individual crane's load chart, operating instructions and other instructional plates must be read and understood prior to operating the crane.

GROVE

working range

171' Main Boom with Manual Offset 32.8 ft. and 55.8 ft. Swingaway

3

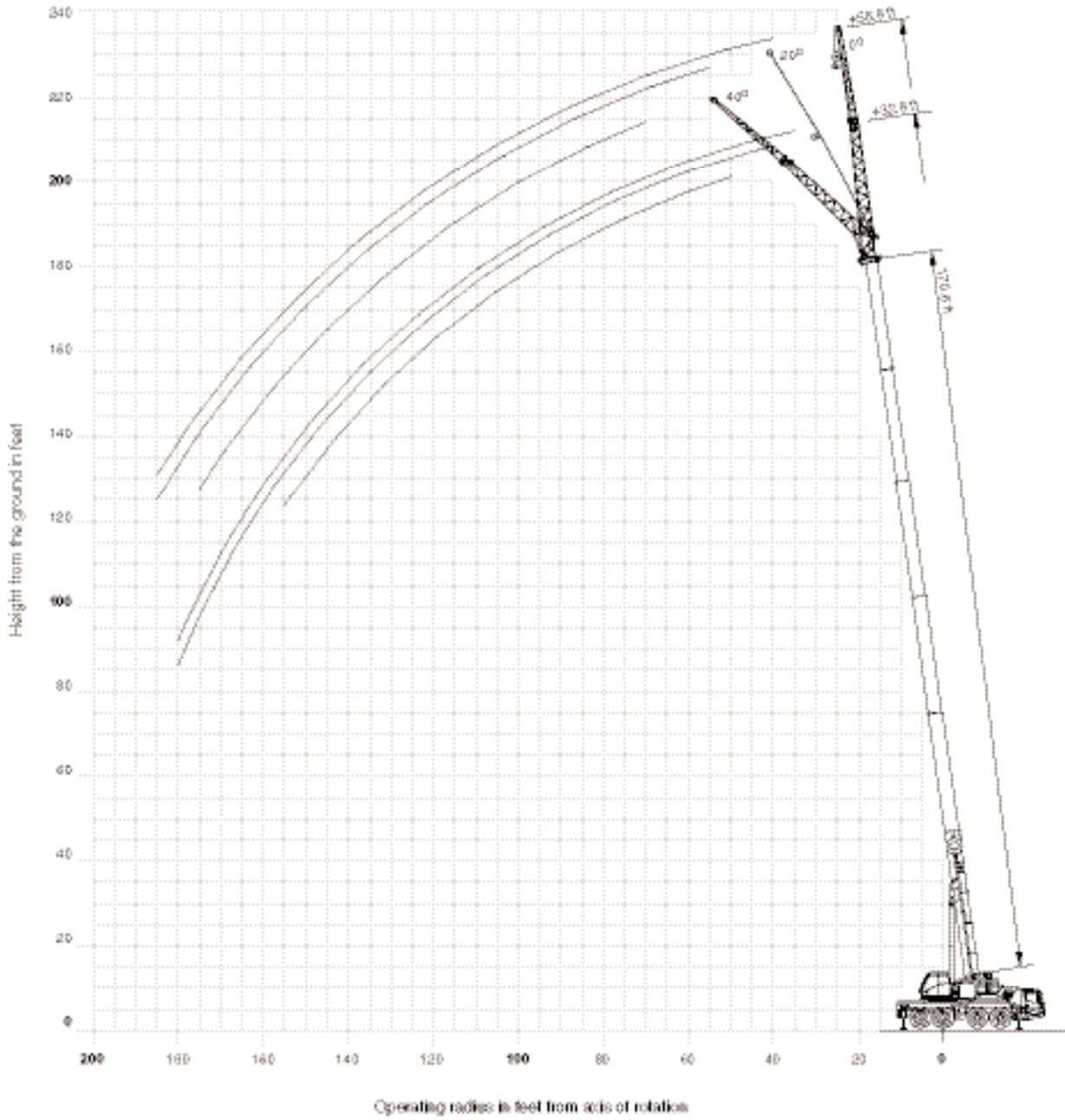

GMK4115

GROVE.

THIS CHART IS ONLY A GUIDE AND SHOULD NOT BE USED TO OPERATE THE CRANE. The individual crane's load chart, operating instructions and other instructional plates must be read and understood prior to operating the crane.

working range

171' Main Boom with Manual Offset 55.8 ft. Swingaway and 2 x 16 ft. Inserts

4

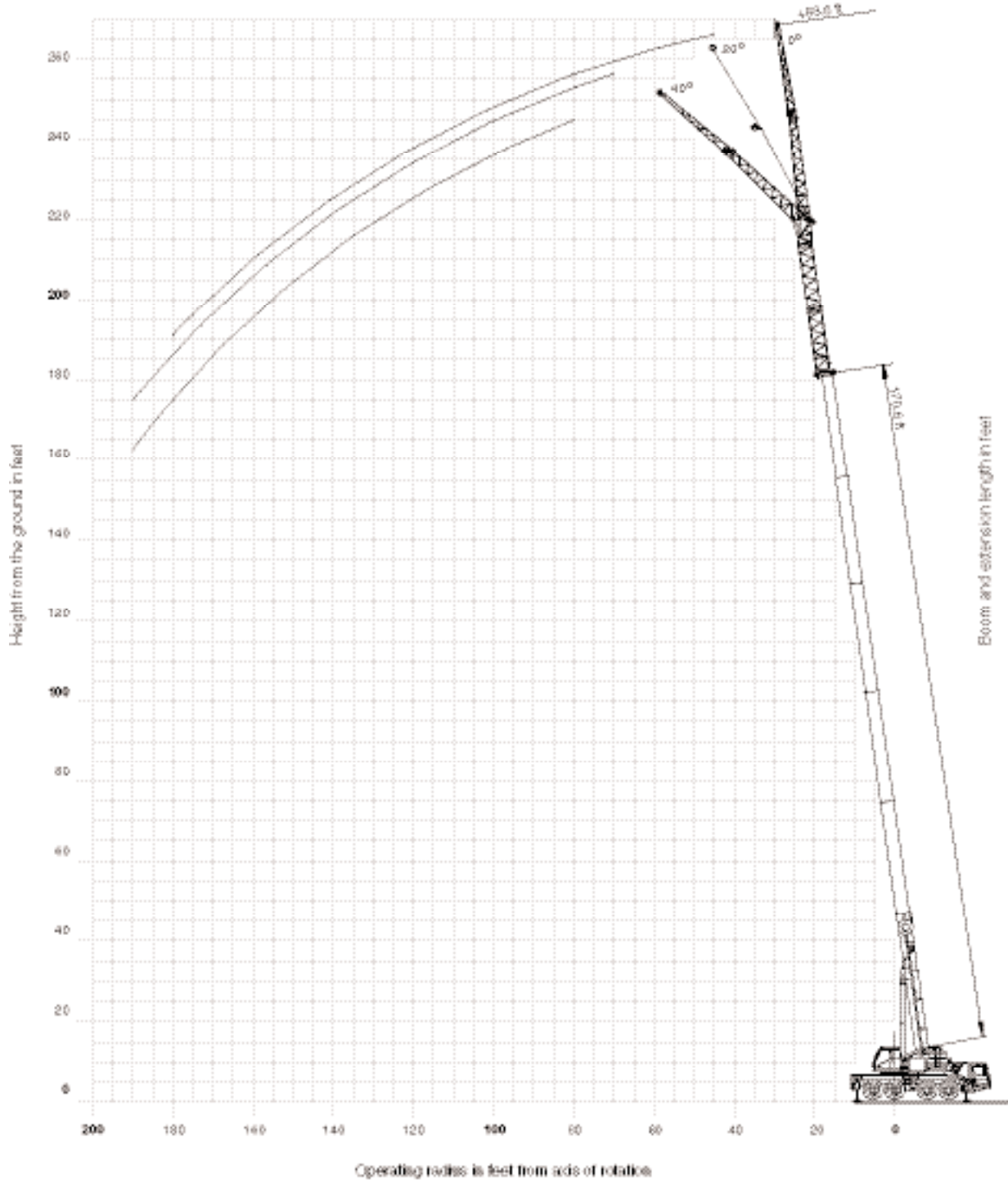

GMK4115

THIS CHART IS ONLY A GUIDE AND SHOULD NOT BE USED TO OPERATE THE CRANE. The individual crane's load chart, operating instructions and other instructional plates must be read and understood prior to operating the crane.

GROVE

load charts

5



171 ft.
(52 m)



32.8-55.8-72.2-88.6 ft
(10-17-22-27 m)
Manual Offset



57,500 lbs.
(26 082 kg)



100%
23' spread



360°



Pounds x1000

Radius	170.6' + 32.8'			170.6' + 55.8'			170.6' + 72.2'			170.6' + 88.6'		
	0°	20°	40°	0°	20°	40°	0°	20°	40°	0°	20°	40°
35	10.8											
40	10.8	10.8		7.4			5.8					
45	10.8	10.8		7.4			5.8			4.0		
50	10.8	10.8	10.0	7.4			5.8			4.0		
55	10.8	10.8	10.0	7.7	7.4		5.8			4.0		
60	10.8	10.8	10.0	7.4	7.4		5.8	5.8		4.0		
65	10.8	10.8	10.0	7.4	7.4		5.8	5.8		4.0		
70	10.8	10.8	10.0	7.4	7.4	6.2	5.8	5.8		4.0	4.0	
75	10.8	10.8	10.0	7.4	7.4	6.2	5.8	5.8	5.6	4.0	4.0	
80	10.8	10.8	10.0	7.4	7.4	6.2	5.8	5.8	5.6	4.0	4.0	4.0
85	10.8	10.4	10.0	7.4	7.4	6.2	5.8	5.8	5.6	4.0	4.0	4.0
90	10.4	10.0	9.8	7.4	7.2	6.2	5.8	5.8	5.6	4.0	4.0	4.0
95	10.0	9.8	9.6	7.4	7.2	6.0	5.8	5.8	5.6	4.0	4.0	4.0
100	9.4	9.4	9.2	7.4	7.0	6.0	5.8	5.8	5.6	4.0	4.0	4.0
105	9.0	9.0	9.0	7.4	6.8	6.0	5.8	5.8	5.6	4.0	4.0	4.0
110	8.4	8.6	8.6	7.4	6.8	5.8	5.8	5.8	5.6	4.0	4.0	4.0
115	8.0	8.2	8.4	7.2	6.6	5.8	5.8	5.6	5.6	4.0	4.0	4.0
120	7.4	7.6	8.0	6.8	6.4	5.8	5.8	5.6	5.4	4.0	4.0	4.0
125	7.0	7.2	7.6	6.6	6.4	5.8	5.6	5.4	5.2	4.0	4.0	4.0
130	6.4	6.8	7.0	6.4	6.2	5.6	5.4	5.2	5.0	4.0	4.0	4.0
135	5.8	6.2	6.4	6.0	6.0	5.6	5.2	5.0	5.0	4.0	4.0	4.0
140	5.0	5.4	5.6	5.6	5.8	5.6	5.0	4.8	4.8	4.0	4.0	4.0
145	4.6	4.8	5.0	5.0	5.6	5.6	4.8	4.6	4.6	3.8	3.8	3.8
150	4.0	4.4	4.4	4.4	5.2	5.4	4.2	4.6	4.6	3.6	3.6	3.6
155	3.4	3.8	3.8	4.0	4.6	5.0	3.8	4.4	4.4	3.6	3.6	3.6
160	3.0	3.2		3.6	4.2	4.4	3.4	4.0	4.2	3.2	3.4	3.4
165	2.6	2.8		3.0	3.6	4.0	2.8	3.6	4.0	2.8	3.2	3.4
170	2.2	2.4		2.6	3.2	3.4	2.4	3.0	3.4	2.4	3.0	3.2
175	1.8	2.0		2.2	2.8	3.0	2.0	2.6	3.0	2.0	2.6	3.0
180	1.4	1.6		2.0	2.4		1.8	2.2	2.4	1.6	2.2	2.6
185				1.6	2.0			1.8	2.0		1.8	2.2
190					1.6			1.4	1.6		1.6	1.8

GMK4115

GROVE.

THIS CHART IS ONLY A GUIDE AND SHOULD NOT BE USED TO OPERATE THE CRANE. The individual crane's load chart, operating instructions and other instructional plates must be read and understood prior to operating the crane.

load charts

6

171 ft.
(52 m)

32.8-55.8-72.2-88.6 ft
(10-17-22-27 m)
Manual Offset

52,600 lbs.
(23 859 kg)

100%
23' spread

360°



Pounds x1000

Radius	170.6' + 32.8'			170.6' + 55.8'			170.6' + 72.2'			170.6' + 88.6'		
	0°	20°	40°	0°	20°	40°	0°	20°	40°	0°	20°	40°
35	10.8											
40	10.8	10.8		7.4			5.8					
45	10.8	10.8		7.4			5.8			4.0		
50	10.8	10.8	10.0	7.4			5.8			4.0		
55	10.8	10.8	10.0	7.7	7.4		5.8			4.0		
60	10.8	10.8	10.0	7.4	7.4		5.8	5.8		4.0		
65	10.8	10.8	10.0	7.4	7.4		5.8	5.8		4.0		
70	10.8	10.8	10.0	7.4	7.4	6.2	5.8	5.8		4.0	4.0	
75	10.8	10.8	10.0	7.4	7.4	6.2	5.8	5.8	5.6	4.0	4.0	
80	10.8	10.8	10.0	7.4	7.4	6.2	5.8	5.8	5.6	4.0	4.0	4.0
85	10.8	10.4	10.0	7.4	7.4	6.2	5.8	5.8	5.6	4.0	4.0	4.0
90	10.4	10.0	9.8	7.4	7.2	6.2	5.8	5.8	5.6	4.0	4.0	4.0
95	10.0	9.8	9.6	7.4	7.2	6.0	5.8	5.8	5.6	4.0	4.0	4.0
100	9.4	9.4	9.2	7.4	7.0	6.0	5.8	5.8	5.6	4.0	4.0	4.0
105	9.0	9.0	9.0	7.4	6.8	6.0	5.8	5.8	5.6	4.0	4.0	4.0
110	8.4	8.6	8.6	7.4	6.8	5.8	5.8	5.8	5.6	4.0	4.0	4.0
115	7.6	8.2	8.4	7.2	6.6	5.8	5.8	5.6	5.6	4.0	4.0	4.0
120	7.0	7.4	7.8	6.8	6.4	5.8	5.8	5.6	5.4	4.0	4.0	4.0
125	6.2	6.8	7.0	6.6	6.4	5.8	5.6	5.4	5.2	4.0	4.0	4.0
130	5.6	6.0	6.4	6.0	6.2	5.6	5.4	5.2	5.0	4.0	4.0	4.0
135	5.0	5.4	5.6	5.4	6.0	5.6	5.0	5.0	5.0	4.0	4.0	4.0
140	4.4	4.8	5.0	4.8	5.6	5.6	4.6	4.8	4.8	4.0	4.0	4.0
145	3.8	4.2	4.4	4.2	5.0	5.6	4.0	4.6	4.6	3.8	3.8	3.8
150	3.2	3.6	3.8	3.8	4.4	5.0	3.6	4.2	4.6	3.4	3.6	3.6
155	2.8	3.2	3.2	3.4	4.0	4.4	3.2	3.8	4.2	3.0	3.6	3.6
160	2.4	2.6		2.8	3.4	3.8	2.6	3.4	3.8	2.6	3.2	3.4
165	2.0	2.2		2.4	3.0	3.2	2.2	3.0	3.2	2.2	2.8	3.2
170	1.6	1.8		2.0	2.6	2.8	1.8	2.4	2.8	1.8	2.4	2.8
175				1.6	2.2	2.4	1.6	2.0	2.4	1.4	2.0	2.4
180					1.8			1.6	2.0		1.6	2.0
185									1.4			1.6

GMK4115

THIS CHART IS ONLY A GUIDE AND SHOULD NOT BE USED TO OPERATE THE CRANE. The individual crane's load chart, operating instructions and other instructional plates must be read and understood prior to operating the crane.

GROVE

load charts

7



171 ft.
(52 m)



32.8-55.8-72.2-88.6 ft
(10-17-22-27 m)
Manual Offset



42,900 lbs.
(19 459 kg)



100%
23' spread



360°



Pounds x1000

Radius	170.6' + 32.8'			170.6' + 55.8'			170.6' + 72.2'			170.6' + 88.6'		
	0°	20°	40°	0°	20°	40°	0°	20°	40°	0°	20°	40°
35	10.8											
40	10.8	10.8		7.4			5.8					
45	10.8	10.8		7.4			5.8			4.0		
50	10.8	10.8	10.0	7.4			5.8			4.0		
55	10.8	10.8	10.0	7.7	7.4		5.8			4.0		
60	10.8	10.8	10.0	7.4	7.4		5.8	5.8		4.0		
65	10.8	10.8	10.0	7.4	7.4		5.8	5.8		4.0		
70	10.8	10.8	10.0	7.4	7.4	6.2	5.8	5.8		4.0	4.0	
75	10.8	10.8	10.0	7.4	7.4	6.2	5.8	5.8	5.6	4.0	4.0	
80	10.8	10.8	10.0	7.4	7.4	6.2	5.8	5.8	5.6	4.0	4.0	4.0
85	10.8	10.4	10.0	7.4	7.4	6.2	5.8	5.8	5.6	4.0	4.0	4.0
90	10.2	10.0	9.8	7.4	7.2	6.2	5.8	5.8	5.6	4.0	4.0	4.0
95	9.2	9.8	9.6	7.4	7.2	6.0	5.8	5.8	5.6	4.0	4.0	4.0
100	8.2	8.8	9.2	7.4	7.0	6.0	5.8	5.8	5.6	4.0	4.0	4.0
105	7.4	8.0	8.4	7.4	6.8	6.0	5.8	5.8	5.6	4.0	4.0	4.0
110	6.6	7.2	7.6	6.8	6.8	5.8	5.8	5.8	5.6	4.0	4.0	4.0
115	5.8	6.4	6.8	6.2	6.6	5.8	5.8	5.6	5.6	4.0	4.0	4.0
120	5.2	5.8	6.0	5.6	6.4	5.8	5.2	5.6	5.4	4.0	4.0	4.0
125	4.6	5.0	5.4	5.0	5.8	5.8	4.6	5.4	5.2	4.0	4.0	4.0
130	4.0	4.4	4.8	4.4	5.2	5.6	4.0	5.0	5.0	3.8	4.0	4.0
135	3.4	3.8	4.0	3.8	4.6	5.2	3.6	4.4	5.0	3.4	4.0	4.0
140	2.8	3.2	3.4	3.4	4.2	4.6	3.0	3.8	4.4	3.0	3.8	4.0
145	2.4	2.8	3.0	3.0	3.6	4.2	2.6	3.4	4.0	2.6	3.2	3.8
150	2.0	2.2	2.4	2.4	3.2	3.6	2.2	3.0	3.4	2.2	2.8	3.4
155	1.6	1.8	2.0	2.0	2.6	3.0	1.8	2.6	3.0	1.8	2.4	2.8
160				1.6	2.2	2.6		2.2	2.6		2.0	2.4
165					1.8	2.0		1.6	2.0		1.6	2.0
170						1.6			1.6			1.6

GMK4115

GROVE

THIS CHART IS ONLY A GUIDE AND SHOULD NOT BE USED TO OPERATE THE CRANE. The individual crane's load chart, operating instructions and other instructional plates must be read and understood prior to operating the crane.

notes

notes

9

GMK4115

GMK4115

GROVE.

notes

notes

10

GMK4115

GROVE.

GMK4115

Regional Headquarters

Americas

Manitowoc, Wisconsin, USA

Tel: +1 920 684 6621

Fax: +1 920 683 6278

Shady Grove, Pennsylvania, USA

Tel: +1 717 597 8121

Fax: +1 717 597 4062

Regional Offices

Americas

Brazil

Alphaville

Tel: +55 11 4688 2716

Fax: +55 11 8489 4671

Mexico

Monterrey

Tel: +52 81 8124 0128

Fax: +52 81 8124 0129

Europe, Middle East, Africa

Algers

Hydra

Tel: +21 3 21 48 1173

Fax: +21 3 21 48 1454

Czech Republic

Netvorice

Tel: +420 317 78 9313

Fax: +420 317 78 9314

France

Baudemont

Tel: +33 385 28 2589

Fax: +33 385 28 0430

Cergy

Tel: +33 130 31 3150

Fax: +33 130 38 6085

Decines

Tel: +33 472 81 5000

Fax: +33 472 81 5010

Germany

Langenfeld

Tel: +49 21 73 8909-0

Fax: +49 21 73 8909 30

Hungary

Budapest

Tel: +36 13 39 8622

Fax: +36 13 39 8622

Italy

Parabiago

Tel: +390 331 49 3311

Fax: +390 331 49 3330

Europe, Middle East, Africa

Ecully, France

Tel: +33 472 18 2020

Fax: +33 472 18 2000

Netherlands

Breda

Tel: +31 76 578 3999

Fax: +31 76 578 3978

Poland

Warsaw

Tel: +48 22 843 3824

Fax: +48 22 843 3471

Portugal

Alfena

Tel: +351 229 69 8840

Fax: +351 229 69 8848

Lisbon

Tel: +351 212 109 340

Fax: +351 212 109 349

Russia

Moscow

Tel: +7 495 641 2359

Fax: +7 495 641 2358

U.A.E.

Dubai

Tel: +971 4 3381 861

Fax: +971 4 3382 343

U. K.

Middlesex

Tel: +44 1 895 43 0053

Fax: +44 1 895 45 9500

Sunderland

Tel: +44 191 522 2000

Fax: +44 191 522 2052

Asia – Pacific

Australia

Melbourne

Tel: +61 3 9 336 1300

Fax: +61 3 9 336 1322

Sydney

Tel: +61 2 9 896 4433

Fax: +61 2 9 896 3122

Asia – Pacific

Shanghai, China

Tel: +86 21 51113579

Fax: +86 21 51113578

Singapore

Tel: +65 6264 1188

Fax: +65 6862 4142

China

Beijing

Tel: +86 10 64671690

Fax: +86 10 64671691

Xi'an

Tel: +86 29 87891465

Fax: +86 29 87884504

Korea

Seoul

Tel: +82 2 508 3361

Fax: +82 2 508 3365

Phillipines

Makati City

Tel: +63 2 844 9437

Fax: +63 2 844 4712

Factories

U.S.A.

Manitowoc

Shady Grove

Brazil

Alphaville

France

Charlieu

La Clayette

Moulines

India

Calcutta

Puna

Italy

Niella Tanaro

Germany

Wilhelmshaven

Portugal

Fânzeres

China

Zhangjiagang

dimensions

Weights & Dimensions

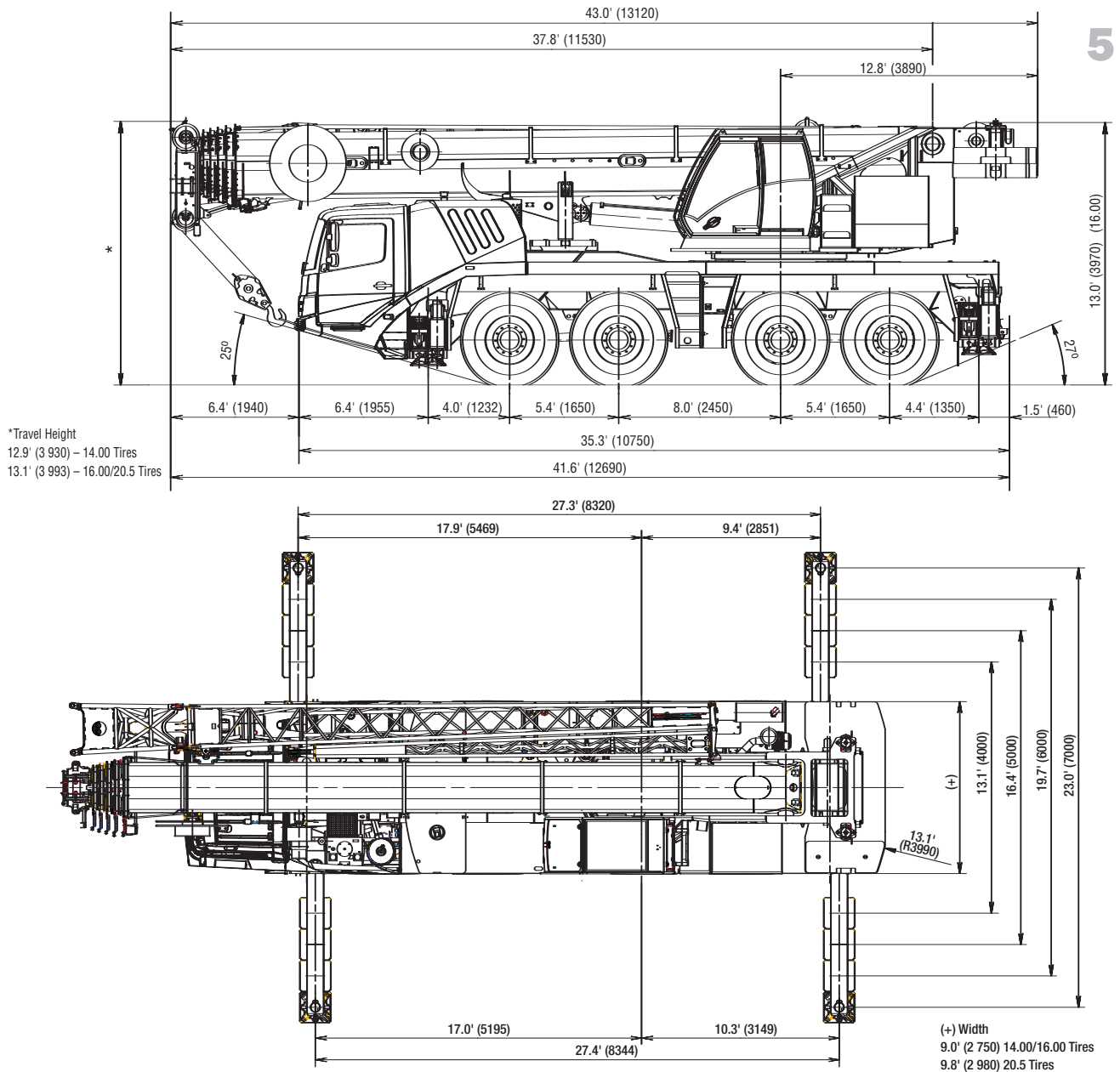

Basic Weights - lb. (kg.)

	Axles 1 & 2		Axles 2 & 3		Total	
Mercedes power, 14.00R25 tires, 8x6x8 drive/steer, 2nd oil cooler, outrigger floats installed, 7,716 lb. (3.5 t) bolted counterweight	47,503	(21547)	47,008	(21323)	94,511	(42870)
Additions:						
16.00R25 tires plus decking	584	(265)	584	(265)	1168	(530)
20.5R25 tires plus decking	955	(433)	955	(433)	1,910	(866)
14.00R25 spare tire with bracket	-395	(-179)	968	(439)	573	(260)
16.00R25 spare tire with bracket	-489	(-222)	1,195	(542)	705	(320)
20.5R25 spare tire with bracket	-560	(-254)	1,358	(616)	798	(362)
8X8X8 drive/steer	575	(261)	152	(69)	728	(330)
Electric driveline retarder	-60	(-27)	633	(287)	573	(260)
Brackets for swingaway	218	(99)	-20	(-9)	198	(90)
Hose reel for luffing swingaway	747	(339)	-362	(-164)	386	(175)
33-56 ft. (10-17 m) swingaway	3,545	(1608)	-668	(-303)	2,877	(1305)
Auxiliary boom nose	304	(138)	-172	(-78)	132	(60)
Auxiliary hoist	-340	(-154)	990	(449)	650	(295)
Removals:						
Outrigger floats (front and rear)	-128	(-58)	-137	(-62)	-265	(-120)

GMK4115

GROVE

trailing boom proposal

Trailing Boom Weights

6

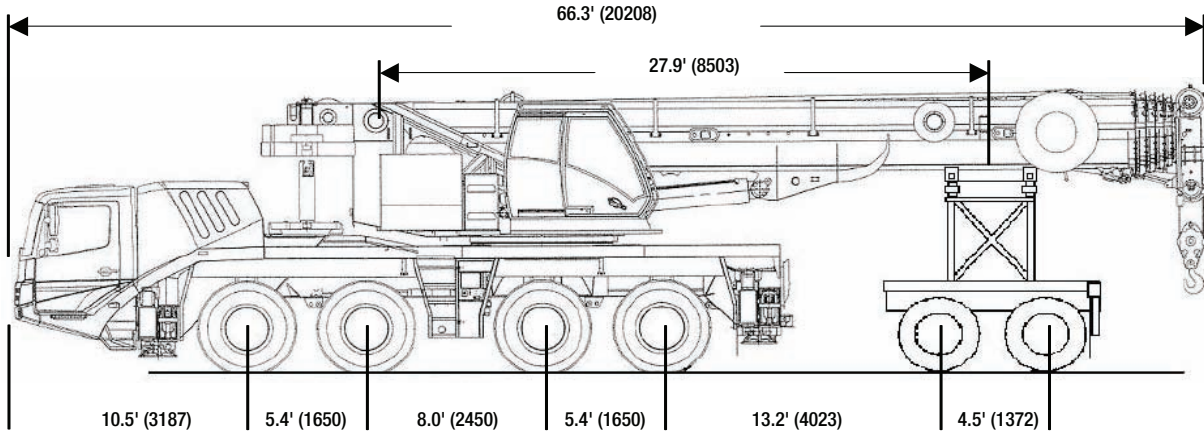

Basic Weights - lb. (kg.)	Axles 1 & 2		Axles 3 & 4		Dolly		Total	
Mercedes power, 16.00 tires, 8x8 drive/steer, outrigger pads stowed, auxiliary hoist, 56 ft. hydraulic luffing swingaway stowed, additional oil cooler, 7,716 lb. (3500 kg.) counterweight slab bolted to superstructure and 6,000 lb. boom dolly. 13 tons of extend boom boost with boom telescoped 12.2 ft.	38,736	(17571)	38,601	(17510)	29,059	(13181)	106,397	(48262)
Additions:								
14.00R25 tires	-584	(-265)	-584	(-265)	-	-	-1,168	(-530)
20.5R25 tires	370	(168)	370	(168)	-	-	740	(336)
8x8 drive/steer	575	(261)	152	(69)	-	-	728	(330)
Remove:								
Hydraulic hose reel	31	(14)	9	(4)	-428	(-194)	-387	(-175)
Brackets for swingaway	-44	(-20)	-13	(-6)	-139	(-63)	-197	(-90)
33 - 56 ft. (10 - 17 m) swingaway	-509	(-231)	-159	(-72)	-2209	(-1002)	-2877	(-1305)
Front and rear outrigger floats	-130	(-59)	-135	(-61)	-	-	-265	(-120)

GMK4115

GROVE

counterweight

7

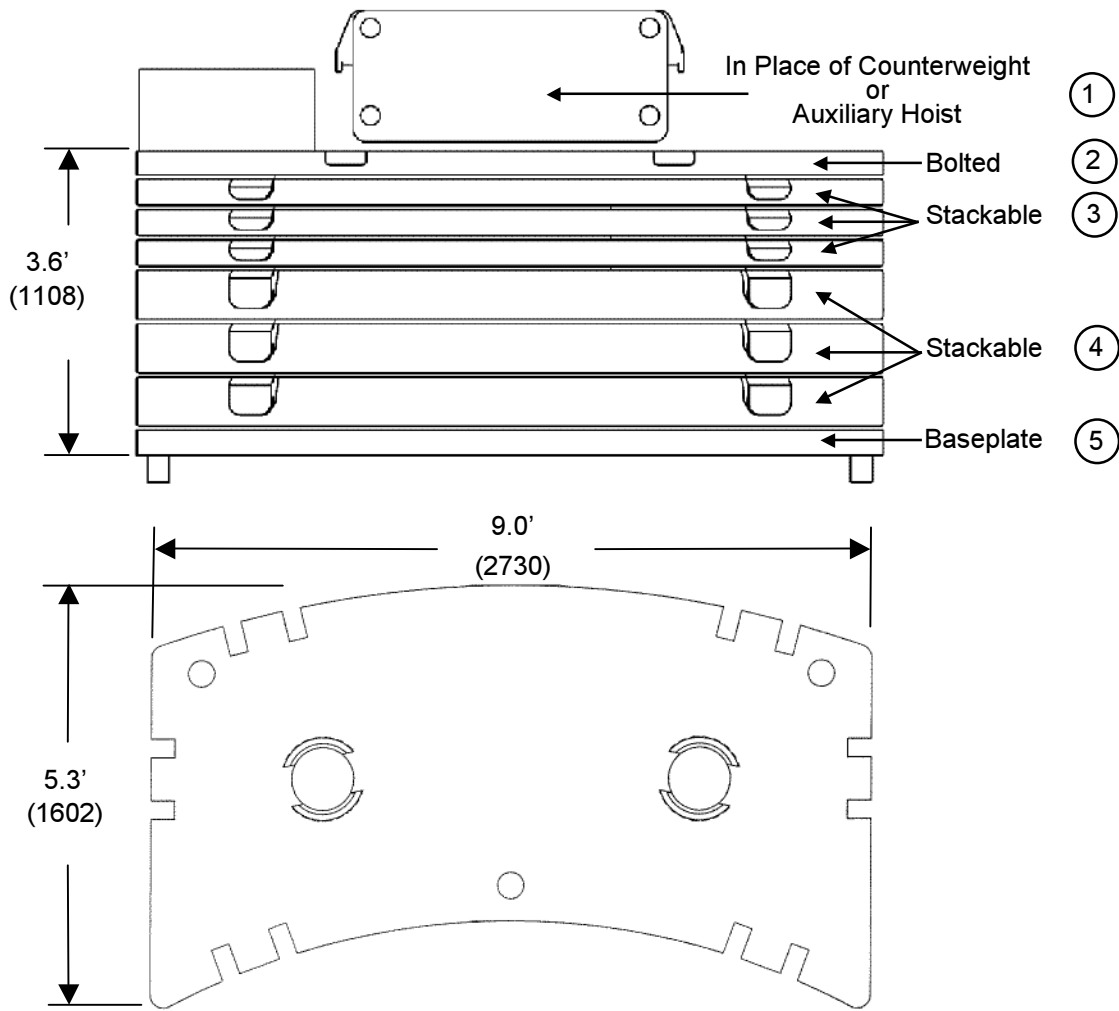

	1	2	3	4	5
	1,300 (600)	7,700 (3500)	4,850 (2200)	9,700 (4400)	4,850 (2200)
Counterweight Configuration lb.(kg.)					
9000 (4100)	X	X			
13,800 (6300)	X	X			X
18,700 (8500)	X	X	X		X
23,500 (10700)	X	X		X	X
28,400 (12900)	X	X	X	X	X
33,200 (15100)	X	X		2X	X
38,100 (17300)	X	X	X	2X	X
42,900 (19500)	X	X	2X	2X	X
47,800 (21700)	X	X	X	3X	X
52,600 (23900)	X	X	2X	3X	X
57,500 (26100)	X	X	3X	3X	X

GMK4115

working range

37'-171' Main Boom

8

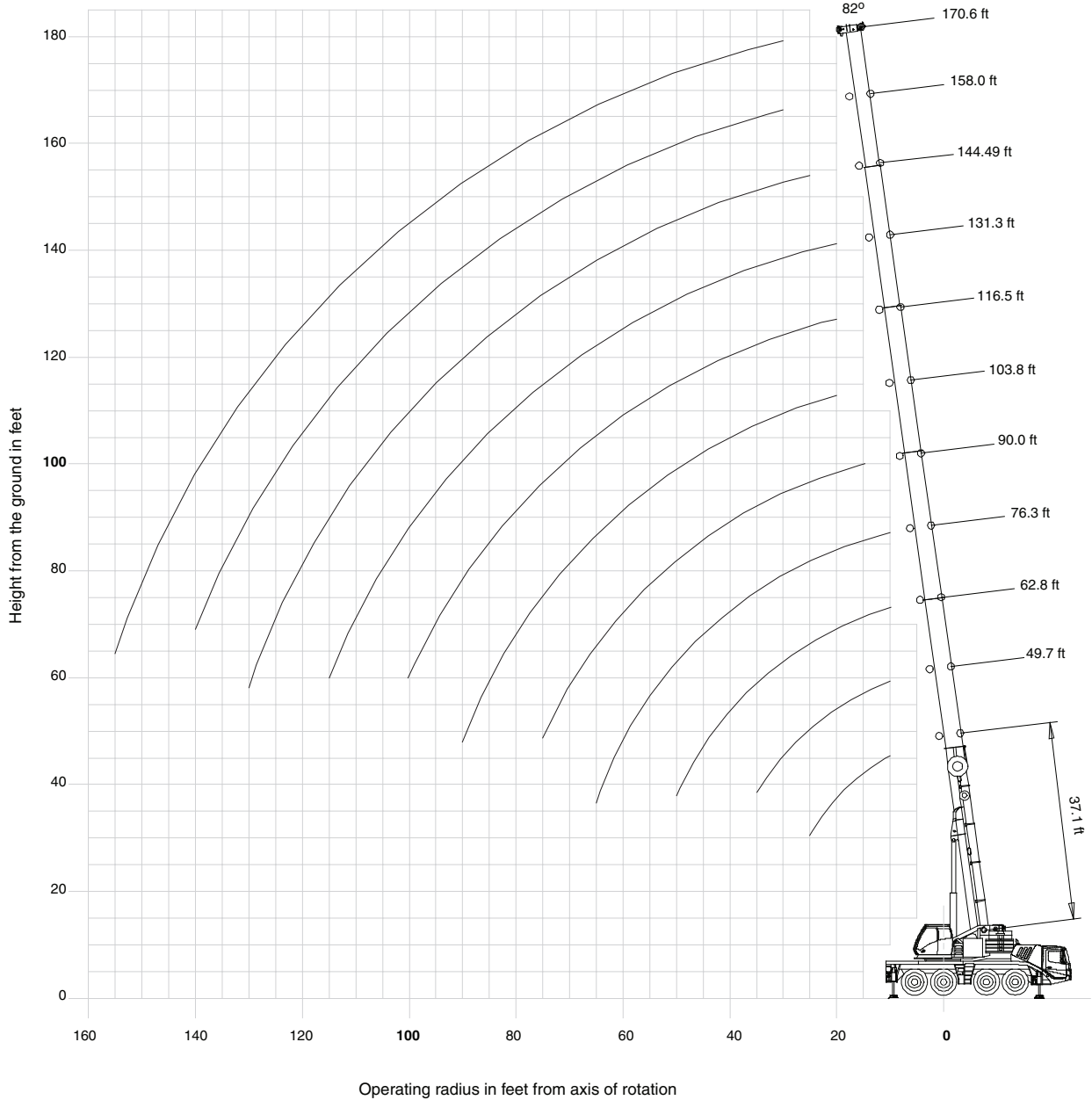





GMK4115

GROVE





THIS CHART IS ONLY A GUIDE AND SHOULD NOT BE USED TO OPERATE THE CRANE. The individual crane's load chart, operating instructions and other instructional plates must be read and understood prior to operating the crane.

load charts

 **37-171 ft.**
 (11.3-52 m)
  **57,500 lbs.**
 (26 082 kg)
  **100%**
 23' spread
  **360°**

Feet	37.1'	49.7'	62.8'	76.3'	90.0'	103.8'	116.5'	131.3'	144.9'	158.0'	170.6'
8	* 230.0										
10	161.0	146.0	138.0	123.0							
15	126.0	123.0	115.0	108.0	93.0						
20	101.0	102.0	95.0	89.0	84.0	71.0	56.0	41.8			
25	85.0	85.0	80.0	75.0	72.0	65.0	52.0	41.8	32.2		
30		73.0	70.0	65.0	62.0	58.0	47.0	41.0	32.2	25.4	21.0
35		63.0	62.0	56.0	54.0	53.0	42.0	37.8	32.2	25.4	21.0
40			52.0	49.0	48.0	47.0	37.6	34.2	31.4	25.4	21.0
45			43.2	42.6	41.6	41.6	34.0	31.0	28.8	25.4	21.0
50			37.8	37.8	36.0	36.2	30.8	28.4	26.4	24.2	21.0
55				32.6	32.4	31.8	28.0	25.6	24.2	22.6	20.8
60				28.4	29.6	28.2	25.6	23.2	21.8	21.0	19.6
65				24.8	26.2	25.2	24.0	21.4	20.2	19.4	18.4
70					23.4	22.4	22.8	19.8	18.8	18.0	17.4
75					20.8	19.8	21.0	18.4	17.4	16.8	16.4
80						18.6	18.8	16.6	16.0	15.4	15.2
85						17.8	16.8	15.4	14.6	14.2	14.0
90						16.2	15.2	14.6	13.2	12.8	12.6
95							13.8	13.6	12.2	11.8	11.8
100							12.4	12.6	11.2	11.0	11.0
105								11.8	10.6	10.2	10.2
110								10.8	10.2	9.6	9.8
115								9.8	9.8	9.2	9.0
120									9.0	8.6	8.0
125									8.2	8.0	7.2
130									7.6	7.2	6.6
135										6.6	5.8
140										6.0	5.2
145											4.6
150											4.2
155											3.6

* Over the rear with special equipment

 **37-171 ft.**
 (11.3-52 m)
  **52,600 lbs.**
 (23 859 kg)
  **100%**
 23' spread
  **360°**

Feet	37.1'	49.7'	62.8'	76.3'	90.0'	103.8'	116.5'	131.3'	144.9'	158.0'	170.6'
10	161.0	146.0	138.0	123.0							
15	126.0	123.0	115.0	108.0	93.0						
20	101.0	102.0	95.0	89.0	84.0	71.0	56.0	41.8			
25	84.0	85.0	80.0	75.0	72.0	65.0	52.0	41.8	32.2		
30		72.0	70.0	65.0	62.0	58.0	47.0	41.0	32.2	25.4	21.0
35		61.0	59.0	56.0	54.0	53.0	42.0	37.8	32.2	25.4	21.0
40			49.0	47.0	46.0	46.0	37.6	34.2	31.4	25.4	21.0
45			41.0	41.6	39.2	39.4	34.0	31.0	28.8	25.4	21.0
50			36.0	35.8	35.4	34.2	30.8	28.4	26.4	24.2	21.0
55				30.6	32.0	30.0	28.0	25.6	24.2	22.6	20.8
60				26.6	28.0	26.6	25.6	23.2	21.8	21.0	19.6
65				24.8	24.6	23.6	24.0	21.4	20.2	19.4	18.4
70					21.8	20.8	21.8	19.0	18.8	18.0	17.4
75					19.2	19.6	19.4	17.2	17.0	16.8	16.4
80						18.4	17.4	16.2	15.4	15.4	15.2
85						16.6	15.6	15.4	13.8	14.2	14.0
90						15.0	14.0	14.6	12.6	12.8	12.6
95							12.6	13.2	11.8	11.6	11.8
100							11.4	12.0	11.2	10.8	10.8
105								10.8	10.6	10.2	10.0
110								9.8	9.8	9.6	9.0
115								8.8	9.0	8.8	8.0
120									8.2	8.0	7.2
125									7.4	7.2	6.4
130									6.8	6.4	5.8
135										5.8	5.0
140										5.2	4.6
145											4.0
150											3.4
155											3.0





THIS CHART IS ONLY A GUIDE AND SHOULD NOT BE USED TO OPERATE THE CRANE. The individual crane's load chart, operating instructions and other instructional plates must be read and understood prior to operating the crane.

GROVE

GMK4115

load charts





10

 37-171 ft.
(11.3-52 m)
 42,900 lbs.
(19 459 kg)
 100%
23' spread
 360°



Pounds x 1000

Feet	37.1'	49.7'	62.8'	76.3'	90.0'	103.8'	116.5'	131.3'	144.9'	158.0'	170.6'
10	161.0	146.0	138.0	123.0							
15	125.0	123.0	115.0	108.0	93.0						
20	101.0	101.0	95.0	89.0	84.0	71.0	56.0	41.8			
25	84.0	85.0	80.0	75.0	72.0	65.0	52.0	41.8	32.2		
30		69.0	65.0	61.0	60.0	58.0	47.0	41.0	32.2	25.4	21.0
35		55.0	53.0	52.0	49.0	49.0	42.0	37.8	32.2	25.4	21.0
40			45.0	43.4	42.8	40.8	37.6	34.2	31.4	25.4	21.0
45			37.4	37.0	37.2	35.0	32.8	31.0	28.8	25.4	21.0
50			31.4	32.0	32.2	30.2	29.8	27.4	26.4	24.2	21.0
55				28.6	28.0	26.4	26.8	23.8	23.6	22.6	20.8
60				24.8	24.2	23.4	23.8	20.8	20.8	21.0	19.6
65				21.6	21.2	21.8	21.2	19.4	18.2	18.6	18.4
70					18.6	19.8	18.8	18.2	17.0	16.8	16.8
75					17.4	17.6	16.6	17.0	16.0	15.6	15.0
80						15.6	14.8	15.4	14.8	14.6	13.4
85						14.0	13.2	13.6	13.8	13.2	12.0
90						12.6	12.6	12.2	12.4	12.0	10.8
95							11.8	11.0	11.0	10.8	9.8
100							10.6	10.2	10.0	9.8	8.8
105								9.6	9.2	8.8	8.0
110								8.8	8.2	7.8	7.0
115								8.0	7.4	7.0	6.2
120									6.6	6.2	5.4
125									6.0	5.6	4.8
130									5.4	5.0	4.2
135										4.4	3.6
140										3.8	3.0
145											2.6
150											2.2
155											1.6

 37-171 ft.
(11.3-52 m)
 28,400 lbs.
(12 882 kg)
 100%
23' spread
 360°







Pounds x 1000



Feet	37.1'	49.7'	62.8'	76.3'	90.0'	103.8'	116.5'	131.3'	144.9'	158.0'	170.6'
10	160.0	146.0	138.0	123.0							
15	124.0	123.0	115.0	108.0	93.0						
20	100.0	101.0	93.0	88.0	84.0	71.0	56.0	41.8			
25	77.0	75.0	70.0	68.0	63.0	62.0	52.0	41.8	32.2		
30		58.0	56.0	53.0	49.0	49.0	46.0	41.0	32.2	25.4	21.0
35		44.0	45.0	43.4	42.8	39.8	28.8	35.6	32.2	25.4	21.0
40			36.0	37.6	35.6	33.0	33.2	29.6	29.0	25.4	21.0
45			31.0	31.4	30.0	29.8	28.2	25.6	24.4	24.4	21.0
50			25.8	26.2	25.6	26.2	24.2	23.8	22.6	22.2	21.0
55				22.2	22.6	22.8	21.0	21.0	20.4	19.8	18.4
60				19.2	20.4	20.0	19.0	18.4	18.2	17.2	16.0
65				16.8	17.8	17.2	17.6	16.6	16.2	15.2	14.0
70					15.6	15.0	15.6	15.4	14.4	13.4	12.4
75					13.8	13.6	13.8	13.8	12.8	12.0	10.8
80						12.6	12.2	12.2	11.4	10.6	9.6
85						11.2	10.8	10.8	10.2	9.4	8.4
90						9.0	9.8	9.6	9.0	8.4	7.4
95							8.8	8.6	8.0	7.6	6.6
100							7.8	7.6	7.0	6.6	5.6
105								6.8	6.2	5.8	5.0
110								6.0	5.4	5.0	4.2
115								5.2	4.6	4.2	3.4
120									4.0	3.6	2.8
125									3.4	3.0	2.4
130									3.0	2.6	1.8
135										2.0	
140										1.6	
145											

GMK4115





load charts



11

37-171 ft.
 (11.3-52 m)
 
18,700 lbs.
 (8 482 kg)
 
100%
 23' spread
 
360°

 **Pounds x 1000**

Feet	37.1'	49.7'	62.8'	76.3'	90.0'	103.8'	116.5'	131.3'	144.9'	158.0'	170.6'
10	159.0	146.0	138.0	123.0							
15	123.0	123.0	115.0	108.0	93.0						
20	99.0	91.0	84.0	80.0	74.0	71.0	56.0	41.8			
25	65.0	67.0	63.0	59.0	58.0	54.0	50.0	41.8	32.2		
30		49.0	48.0	48.0	45.0	41.8	41.0	36.8	32.2	25.4	21.0
35		36.8	39.2	38.6	36.2	35.4	33.4	30.4	28.8	25.4	21.0
40			31.4	31.6	29.6	30.0	27.6	27.4	26.2	23.6	21.0
45			25.6	26.0	26.4	25.2	24.0	23.2	22.8	21.6	20.0
50			21.2	21.6	23.0	21.6	21.4	20.8	19.6	18.4	17.0
55				19.4	19.6	18.6	18.6	18.2	17.0	16.0	14.6
60				16.6	16.8	17.2	16.4	15.8	14.8	13.8	12.6
65				14.2	14.4	15.0	14.6	14.0	12.8	12.0	10.8
70					12.6	13.0	12.8	12.2	11.2	10.6	9.4
75					10.8	11.4	11.2	10.8	10.0	9.2	8.2
80						10.0	9.8	9.6	8.8	8.0	7.0
85						8.8	8.6	8.4	7.6	7.0	6.0
90						6.8	7.4	7.2	6.6	6.2	5.2
95							6.6	6.4	5.8	5.4	4.4
100							5.8	5.6	5.0	4.4	3.6
105								4.8	4.2	3.8	3.0
110								4.2	3.4	3.0	2.4
115								3.6	2.8	2.4	1.8
120									2.4	2.0	
125										1.8	
130											

37-171 ft.
 (11.3-52 m)
 
9,000 lbs.
 (4 082 kg)
 
100%
 23' spread
 
360°

 **Pounds x 1000**

Feet	37.1'	49.7'	62.8'	76.3'	90.0'	103.8'	116.5'	131.3'	144.9'	158.0'	170.6'
10	158.0	146.0	138.0	123.0							
15	123.0	123.0	111.0	100.0	93.0						
20	83.0	79.0	74.0	68.0	66.0	60.0	44.0	41.8			
25	53.0	56.0	53.0	52.0	48.0	44.0	43.4	38.2	32.2		
30		40.2	41.4	39.4	36.8	36.6	33.6	32.8	28.6	25.4	21.0
35		30.2	32.2	31.2	29.2	29.4	28.8	27.8	26.0	23.4	21.0
40			25.2	25.4	25.8	24.0	23.8	23.0	21.4	20.2	18.6
45			20.4	22.0	21.6	21.2	20.4	19.4	18.0	16.8	15.4
50			16.6	18.2	18.2	18.2	17.2	16.4	15.2	14.2	13.0
55				15.2	15.4	15.6	14.8	14.0	13.0	12.0	10.8
60				12.8	13.0	13.4	12.8	12.2	11.2	10.4	9.2
65				10.8	11.0	11.4	11.2	10.6	9.6	8.8	7.6
70					9.4	9.8	9.6	9.2	8.2	7.4	6.4
75					8.0	8.4	8.2	8.0	7.0	6.4	5.4
80						7.2	7.0	6.8	6.0	5.4	4.4
85						6.2	6.0	5.8	5.2	4.4	3.6
90						4.2	5.0	4.8	4.2	3.8	2.8
95							4.2	4.0	3.4	3.0	2.0
100							3.6	3.4	2.8	2.4	1.4
105								2.8	2.2	1.8	
110								2.2	1.6		
115										1.6	
120											

GMK4115

THIS CHART IS ONLY A GUIDE AND SHOULD NOT BE USED TO OPERATE THE CRANE. The individual crane's load chart, operating instructions and other instructional plates must be read and understood prior to operating the crane.

working range

171' Main Boom with Hydraulic Luffing 32.8 ft. and 55.8 ft. Swingaway

12

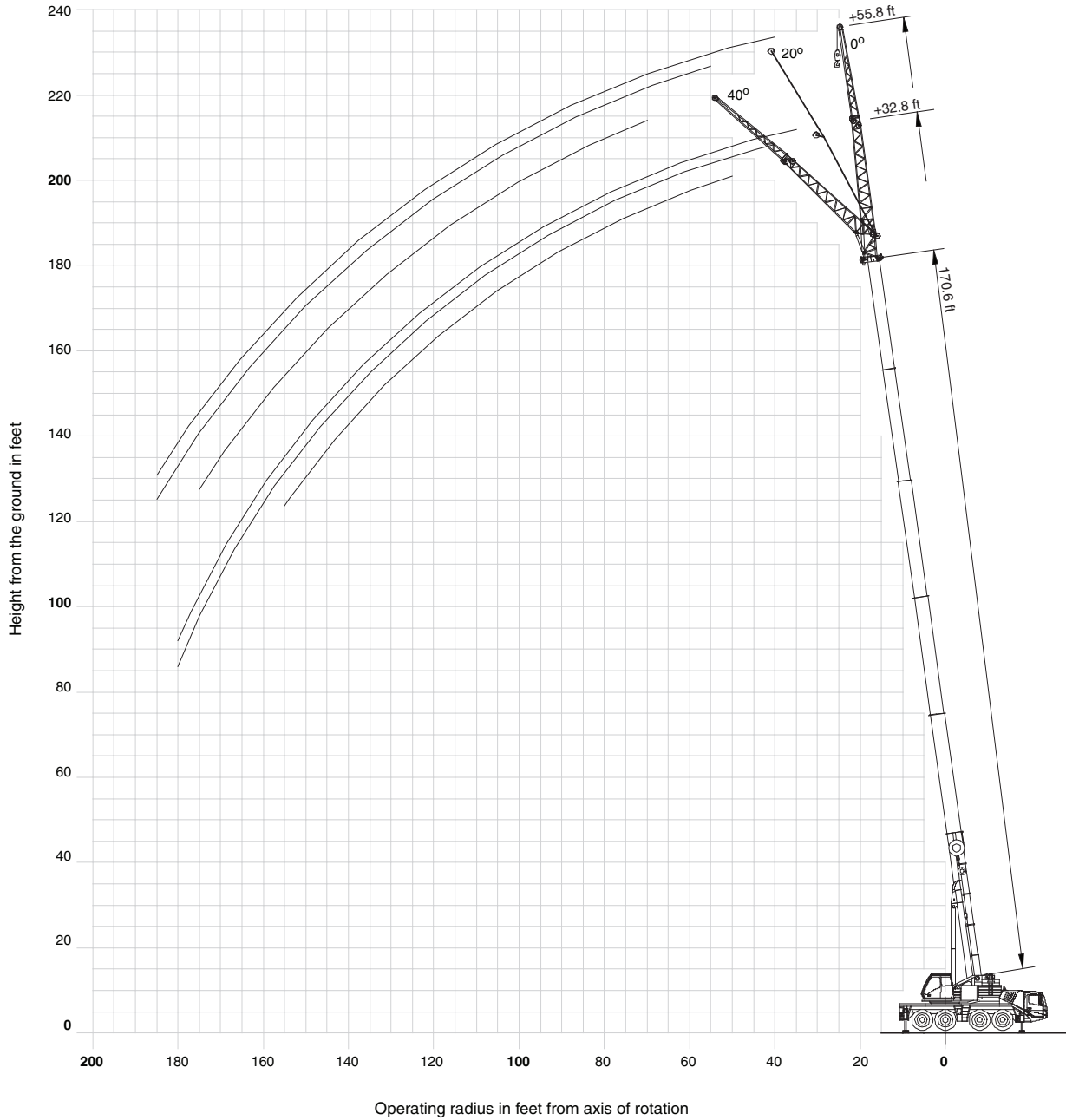

GMK4115

GROVE

THIS CHART IS ONLY A GUIDE AND SHOULD NOT BE USED TO OPERATE THE CRANE. The individual crane's load chart, operating instructions and other instructional plates must be read and understood prior to operating the crane.

working range

171' Main Boom with Hydraulic Luffing, 55.8 ft. Swingaway and 2 x 16 ft. Inserts

13

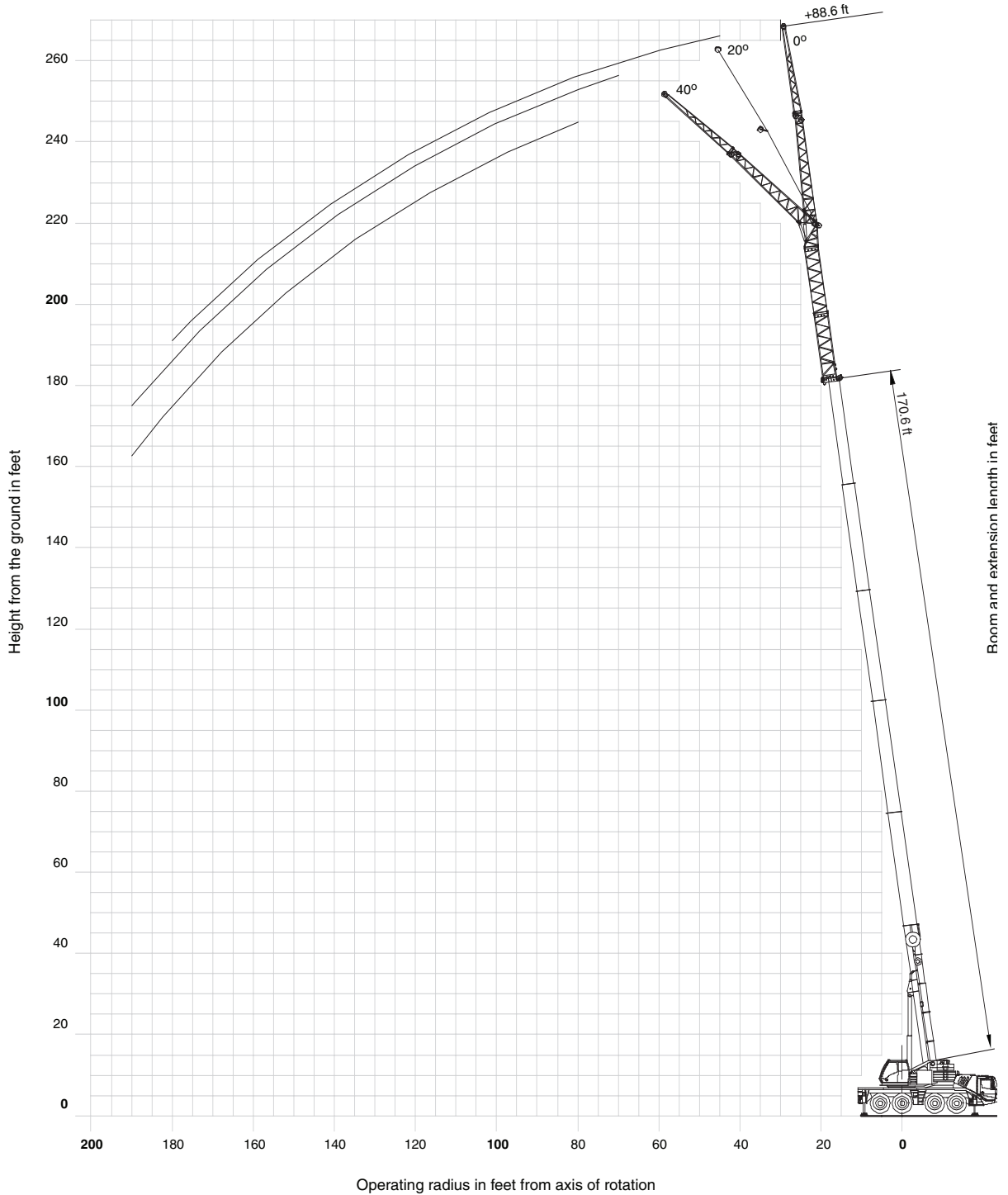

Boom and extension length in feet

GMK4115

THIS CHART IS ONLY A GUIDE AND SHOULD NOT BE USED TO OPERATE THE CRANE. The individual crane's load chart, operating instructions and other instructional plates must be read and understood prior to operating the crane.

GROVE

load charts

14



171 ft.
(52 m)



32.8-55.8-72.2-88.6 ft
(10-17-22-27 m)
Hydraulic Luffing
Stationary



57,500 lbs.
(26 082 kg)



100%
23' spread



360°



Pounds x1000

Radius	170.6' + 32.8'			170.6' + 55.8'			170.6' + 72.2'			170.6' + 88.6'		
	0°	0°-20°	20°-40°	0°	0°-20°	20°-40°	0°	0°-20°	20°-40°	0°	0°-20°	20°-40°
35	10.8											
40	10.8	10.8		7.4			5.8					
45	10.8	10.8		7.4			5.8			4.0		
50	10.8	10.8	10.0	7.4			5.8			4.0		
55	10.8	10.8	10.0	7.7	7.4		5.8			4.0		
60	10.8	10.8	10.0	7.4	7.4		5.8	5.8		4.0		
65	10.8	10.8	10.0	7.4	7.4		5.8	5.8		4.0		
70	10.8	10.8	10.0	7.4	7.4	6.2	5.8	5.8		4.0	4.0	
75	10.8	10.8	10.0	7.4	7.4	6.2	5.8	5.8	5.6	4.0	4.0	
80	10.8	10.8	10.0	7.4	7.4	6.2	5.8	5.8	5.6	4.0	4.0	4.0
85	10.8	10.4	10.0	7.4	7.4	6.2	5.8	5.8	5.6	4.0	4.0	4.0
90	10.4	10.0	9.8	7.4	7.2	6.2	5.8	5.8	5.6	4.0	4.0	
95	10.0	9.8	9.6	7.4	7.2	6.0	5.8	5.8	5.6	4.0	4.0	4.0
100	9.4	9.4	9.2	7.4	7.0	6.0	5.8	5.8	5.6	4.0	4.0	4.0
105	9.0	9.0	9.0	7.4	6.8	6.0	5.8	5.8	5.6	4.0	4.0	4.0
110	8.4	8.6	8.6	7.4	6.8	5.8	5.8	5.8	5.6	4.0	4.0	4.0
115	8.0	8.2	8.4	7.2	6.6	5.8	5.8	5.6	5.6	4.0	4.0	4.0
120	7.4	7.6	8.0	6.8	6.4	5.8	5.8	5.6	5.4	4.0	4.0	4.0
125	7.0	7.0	7.6	6.6	6.4	5.8	5.6	5.4	5.2	4.0	4.0	4.0
130	6.4	6.4	6.8	6.4	6.2	5.6	5.4	5.2	5.0	4.0	4.0	4.0
135	5.8	5.8	6.2	6.0	6.0	5.6	5.2	5.0	5.0	4.0	4.0	4.0
140	5.0	5.0	5.4	5.6	5.6	5.6	5.0	4.8	4.8	4.0	4.0	4.0
145	4.6	4.6	4.8	5.0	5.0	5.6	4.8	4.6	4.6	3.8	3.8	3.8
150	4.0	4.0	4.4	4.4	4.4	5.2	4.2	4.2	4.6	3.6	3.6	3.6
155	3.4	3.4	3.8	4.0	4.0	4.6	3.8	3.8	4.4	3.6	3.6	3.6
160	3.0	3.0		3.6	3.6	4.2	3.4	3.4	4.0	3.2	3.2	3.4
165	2.6	2.6		3.0	3.0	3.6	2.8	2.8	3.6	2.8	2.8	3.4
170	2.2	2.2		2.6	2.6	3.2	2.4	2.4	3.0	2.4	2.4	3.0
175	1.8	1.8		2.2	2.2	2.8	2.0	2.0	2.6	2.0	2.0	2.6
180	1.4	1.4		2.0	2.0		1.8	1.8	2.2	1.6	1.6	2.2
185				1.6	1.6				1.8			1.8
190									1.4			1.6

GMK4115

GROVE

THIS CHART IS ONLY A GUIDE AND SHOULD NOT BE USED TO OPERATE THE CRANE. The individual crane's load chart, operating instructions and other instructional plates must be read and understood prior to operating the crane.

load charts

171 ft.
(52 m)

32.8-55.8-72.2-88.6 ft
(10-17-22-27 m)
Hydraulic Luffing
Loads Luffing

57,500 lbs.
(26 082 kg)

100%
23' spread

360°



Pounds x1000

15

Radius	170.6' + 32.8'		170.6' + 55.8'		170.6' + 72.2'		170.6' + 88.6'	
	0°-20°	20°-40°	0°-20°	20°-40°	0°-20°	20°-40°	0°-20°	20°-40°
35								
40	10.8							
45	10.8							
50	10.8	9.4						
55	10.8	9.4	7.2					
60	10.8	9.4	7.2		5.8			
65	10.8	9.4	7.2		5.8			
70	10.8	9.4	7.2	6.0	5.8		4.0	
75	10.8	9.4	7.2	6.0	5.8	5.2	4.0	
80	10.4	9.4	7.2	6.0	5.8	5.2	4.0	4.0
85	10.0	9.4	7.0	6.0	5.8	5.2	4.0	4.0
90	9.6	9.4	6.8	5.8	5.8	5.2	4.0	4.0
95	9.2	9.2	6.6	5.8	5.8	5.2	4.0	4.0
100	8.8	8.8	6.4	5.6	5.8	5.2	4.0	4.0
105	8.6	8.6	6.2	5.6	5.8	5.2	4.0	4.0
110	8.2	8.2	6.0	5.4	5.6	5.2	4.0	4.0
115	7.8	8.0	6.0	5.4	5.4	5.2	4.0	4.0
120	7.4	7.6	5.8	5.4	5.2	5.2	4.0	4.0
125	6.6	7.2	5.6	5.2	5.0	5.0	4.0	4.0
130	6.0	6.4	5.6	5.2	5.0	4.8	4.0	4.0
135	5.4	5.8	5.4	5.2	4.8	4.8	3.8	3.8
140	4.8	5.2	5.2	5.2	4.6	4.6	3.8	3.8
145	4.4	4.6	4.8	5.0	4.4	4.4	3.6	3.6
150	3.8	4.2	4.2	4.8	4.2	4.4	3.4	3.4
155	3.4	3.6	3.8	4.4	3.6	4.2	3.4	3.4
160	3.0		3.4	4.0	3.2	3.8	3.2	3.2
165	2.6		3.0	3.6	2.8	3.4	2.8	3.2
170	2.2		2.6	3.2	2.4	3.0	2.4	3.0
175	1.8		2.2	2.8	2.0	2.6	2.0	2.6
180	1.4		2.0		1.8	2.2	1.6	2.2
185			1.6			1.8		1.8
190						1.4		1.6

THIS CHART IS ONLY A GUIDE AND SHOULD NOT BE USED TO OPERATE THE CRANE. The individual crane's load chart, operating instructions and other instructional plates must be read and understood prior to operating the crane.

GROVE

GMK4115

load charts

16



171 ft.
(52 m)



32.8-55.8-72.2-88.6 ft
(10-17-22-27 m)
Hydraulic Luffing
Stationary



52,600 lbs.
(23 859 kg)



100%
23' spread



360°



Pounds x1000

Radius	170.6' + 32.8'			170.6' + 55.8'			170.6' + 72.2'			170.6' + 88.6'		
	0°	0°-20°	20°-40°	0°	0°-20°	20°-40°	0°	0°-20°	20°-40°	0°	0°-20°	20°-40°
35	10.8											
40	10.8	10.8		7.4			5.8					
45	10.8	10.8		7.4			5.8			4.0		
50	10.8	10.8	10.0	7.4			5.8			4.0		
55	10.8	10.8	10.0	7.7	7.4		5.8			4.0		
60	10.8	10.8	10.0	7.4	7.4		5.8	5.8		4.0		
65	10.8	10.8	10.0	7.4	7.4		5.8	5.8		4.0		
70	10.8	10.8	10.0	7.4	7.4	6.2	5.8	5.8		4.0	4.0	
75	10.8	10.8	10.0	7.4	7.4	6.2	5.8	5.8	5.6	4.0	4.0	
80	10.8	10.8	10.0	7.4	7.4	6.2	5.8	5.8	5.6	4.0	4.0	4.0
85	10.8	10.4	10.0	7.4	7.4	6.2	5.8	5.8	5.6	4.0	4.0	4.0
90	10.4	10.0	9.8	7.4	7.2	6.2	5.8	5.8	5.6	4.0	4.0	4.0
95	10.0	9.8	9.6	7.4	7.2	6.0	5.8	5.8	5.6	4.0	4.0	4.0
100	9.4	9.4	9.2	7.4	7.0	6.0	5.8	5.8	5.6	4.0	4.0	4.0
105	9.0	9.0	9.0	7.4	6.8	6.0	5.8	5.8	5.6	4.0	4.0	4.0
110	8.4	8.4	8.6	7.4	6.8	5.8	5.8	5.8	5.6	4.0	4.0	4.0
115	7.6	7.6	8.2	7.2	6.6	5.8	5.8	5.6	5.6	4.0	4.0	4.0
120	7.0	7.0	7.4	6.8	6.4	5.8	5.8	5.6	5.4	4.0	4.0	4.0
125	6.2	6.2	6.8	6.6	6.4	5.8	5.6	5.4	5.2	4.0	4.0	4.0
130	5.6	5.6	6.0	6.0	6.0	5.6	5.4	5.2	5.0	4.0	4.0	4.0
135	5.0	5.0	5.4	5.4	5.4	5.6	5.0	5.0	5.0	4.0	4.0	4.0
140	4.4	4.4	4.8	4.8	4.8	5.6	4.6	4.6	4.8	4.0	4.0	4.0
145	3.8	3.8	4.2	4.2	4.2	5.0	4.0	4.0	4.6	3.8	3.8	3.8
150	3.2	3.2	3.6	3.8	3.8	4.4	3.6	3.6	4.2	3.4	3.4	3.6
155	2.8	2.8	3.2	3.4	3.4	4.0	3.2	3.2	3.8	3.0	3.0	3.6
160	2.4	2.4		2.8	2.8	3.4	2.6	2.6	3.4	2.6	2.6	3.2
165	2.0	2.0		2.4	2.4	3.0	2.2	2.2	3.0	2.2	2.2	2.8
170	1.6	1.6		2.0	2.0	2.6	1.8	1.8	2.4	1.8	1.8	2.4
175				1.6	1.6	2.2	1.6	1.6	2.0	1.4	1.4	2.0
180									1.6			1.6
185												

GMK4115

GROVE

THIS CHART IS ONLY A GUIDE AND SHOULD NOT BE USED TO OPERATE THE CRANE. The individual crane's load chart, operating instructions and other instructional plates must be read and understood prior to operating the crane.

load charts

17



171 ft.
(52 m)



32.8-55.8-72.2-88.6 ft
(10-17-22-27 m)
Hydraulic Luffing
Loads Luffing



52,600 lbs.
(23 859 kg)



100%
23' spread



360°



 Pounds x1000

Radius	170.6' + 32.8'		170.6' + 55.8'		170.6' + 72.2'		170.6' + 88.6'	
	0°-20°	20°-40°	0°-20°	20°-40°	0°-20°	20°-40°	0°-20°	20°-40°
35								
40	10.8							
45	10.8							
50	10.8	9.4						
55	10.8	9.4	7.2					
60	10.8	9.4	7.2		5.8			
65	10.8	9.4	7.2		5.8			
70	10.8	9.4	7.2	6.0	5.8		4.0	
75	10.8	9.4	7.2	6.0	5.8	5.2	4.0	
80	10.4	9.4	7.2	6.0	5.8	5.2	4.0	4.0
85	10.0	9.4	7.0	6.0	5.8	5.2	4.0	4.0
90	9.6	9.4	6.8	5.8	5.8	5.2	4.0	4.0
95	9.2	9.2	6.6	5.8	5.8	5.2	4.0	4.0
100	8.8	8.8	6.4	5.6	5.8	5.2	4.0	4.0
105	8.6	8.6	6.2	5.6	5.8	5.2	4.0	4.0
110	8.2	8.2	6.0	5.4	5.6	5.2	4.0	4.0
115	7.4	8.0	6.0	5.4	5.4	5.2	4.0	4.0
120	6.6	7.2	5.8	5.4	5.2	5.2	4.0	4.0
125	6.0	6.4	5.6	5.2	5.0	5.0	4.0	4.0
130	5.4	5.8	5.6	5.2	5.0	4.8	4.0	4.0
135	4.8	5.2	5.2	5.2	4.8	4.8	3.8	3.8
140	4.2	4.6	4.6	5.2	4.6	4.6	3.8	3.8
145	3.8	4.0	4.2	4.8	4.0	4.4	3.6	3.6
150	3.2	3.6	3.6	4.2	3.6	4.2	3.4	3.4
155	2.8	3.0	3.2	3.8	3.2	3.8	3.0	3.4
160	2.4		2.8	3.4	2.6	3.2	2.6	3.2
165	2.0		2.4	3.0	2.2	2.8	2.2	2.8
170	1.6		2.0	2.6	1.8	2.4	1.8	2.4
175			1.6	2.2	1.6	2.0	1.4	2.0
180						1.6		1.6
185								

GMK4115

THIS CHART IS ONLY A GUIDE AND SHOULD NOT BE USED TO OPERATE THE CRANE. The individual crane's load chart, operating instructions and other instructional plates must be read and understood prior to operating the crane.

GROVE

load charts

18



171 ft.
(52 m)



32.8-55.8-72.2-88.6 ft
(10-17-22-27 m)
Hydraulic Luffing
Stationary



42,900 lbs.
(19 459 kg)



100%
23' spread



360°



Pounds x1000

Radius	170.6' + 32.8'			170.6' + 55.8'			170.6' + 72.2'			170.6' + 88.6'		
	0°	0°-20°	20°-40°	0°	0°-20°	20°-40°	0°	0°-20°	20°-40°	0°	0°-20°	20°-40°
35	10.8											
40	10.8	10.8		7.4			5.8					
45	10.8	10.8		7.4			5.8			4.0		
50	10.8	10.8	10.0	7.4			5.8			4.0		
55	10.8	10.8	10.0	7.7	7.4		5.8			4.0		
60	10.8	10.8	10.0	7.4	7.4		5.8	5.8		4.0		
65	10.8	10.8	10.0	7.4	7.4		5.8	5.8		4.0		
70	10.8	10.8	10.0	7.4	7.4	6.2	5.8	5.8		4.0	4.0	
75	10.8	10.8	10.0	7.4	7.4	6.2	5.8	5.8	5.6	4.0	4.0	
80	10.8	10.8	10.0	7.4	7.4	6.2	5.8	5.8	5.6	4.0	4.0	4.0
85	10.8	10.4	10.0	7.4	7.4	6.2	5.8	5.8	5.6	4.0	4.0	4.0
90	10.2	10.0	9.8	7.4	7.2	6.2	5.8	5.8	5.6	4.0	4.0	4.0
95	9.2	9.2	9.6	7.4	7.2	6.0	5.8	5.8	5.6	4.0	4.0	4.0
100	8.2	8.2	8.8	7.4	7.0	6.0	5.8	5.8	5.6	4.0	4.0	4.0
105	7.4	7.4	8.0	7.4	6.8	6.0	5.8	5.8	5.6	4.0	4.0	4.0
110	6.6	6.6	7.2	6.8	6.8	5.8	5.8	5.8	5.6	4.0	4.0	4.0
115	5.8	5.8	6.4	6.2	6.2	5.8	5.8	5.6	5.6	4.0	4.0	4.0
120	5.2	5.2	5.8	5.6	5.6	5.8	5.2	5.2	5.4	4.0	4.0	4.0
125	4.6	4.6	5.0	5.0	5.0	5.8	4.6	4.6	5.2	4.0	4.0	4.0
130	4.0	4.0	4.4	4.4	4.4	5.2	4.0	4.0	5.0	3.8	3.8	4.0
135	3.4	3.4	3.8	3.8	3.8	4.6	3.6	3.6	4.4	3.4	3.4	4.0
140	2.8	2.8	3.2	3.4	3.4	4.2	3.0	3.0	3.8	3.0	3.0	3.8
145	2.4	2.4	2.8	3.0	3.0	3.6	2.6	2.6	3.4	2.6	2.6	3.2
150	2.0	2.0	2.2	2.4	2.4	3.2	2.2	2.2	3.0	2.2	2.2	2.8
155	1.6	1.6	1.8	2.0	2.0	2.6	1.8	1.8	2.6	1.8	1.8	2.4
160				1.6	1.6	2.2			2.2			2.0
165						1.8			1.6			1.6
170												

GMK4115

GROVE

THIS CHART IS ONLY A GUIDE AND SHOULD NOT BE USED TO OPERATE THE CRANE. The individual crane's load chart, operating instructions and other instructional plates must be read and understood prior to operating the crane.

load charts

19



171 ft.
(52 m)



32.8-55.8-72.2-88.6 ft
(10-17-22-27 m)
Hydraulic Luffing
Loads Luffing



42,900 lbs.
(19 459 kg)



100%
23' spread



360°



 Pounds x1000

Radius	170.6' + 32.8'		170.6' + 55.8'		170.6' + 72.2'		170.6' + 88.6'	
	0°-20°	20°-40°	0°-20°	20°-40°	0°-20°	20°-40°	0°-20°	20°-40°
35								
40	10.8							
45	10.8							
50	10.8	9.4						
55	10.8	9.4	7.2					
60	10.8	9.4	7.2		5.8			
65	10.8	9.4	7.2		5.8			
70	10.8	9.4	7.2	6.0	5.8		4.0	
75	10.8	9.4	7.2	6.0	5.8	5.2	4.0	
80	10.4	9.4	7.2	6.0	5.8	5.2	4.0	4.0
85	10.0	9.4	7.0	6.0	5.8	5.2	4.0	4.0
90	9.6	9.4	6.8	5.8	5.8	5.2	4.0	4.0
95	9.2	9.2	6.6	5.8	5.8	5.2	4.0	4.0
100	8.2	8.8	6.4	5.6	5.8	5.2	4.0	4.0
105	7.4	8.0	6.2	5.6	5.8	5.2	4.0	4.0
110	6.6	7.2	6.0	5.4	5.6	5.2	4.0	4.0
115	5.8	6.4	6.0	5.4	5.4	5.2	4.0	4.0
120	5.2	5.6	5.6	5.4	5.2	5.2	4.0	4.0
125	4.6	5.0	5.0	5.2	4.6	5.0	4.0	4.0
130	4.0	4.4	4.4	5.2	4.0	4.8	3.8	4.0
135	3.4	3.8	3.8	4.6	3.6	4.4	3.4	3.8
140	2.8	3.2	3.4	4.0	3.0	3.8	3.0	3.8
145	2.4	2.8	3.0	3.6	2.6	3.4	2.6	3.2
150	2.0	2.2	2.4	3.2	2.2	3.0	2.2	2.8
155	1.6	1.8	2.0	2.6	1.8	2.6	1.8	2.4
160			1.6	2.2		2.2		2.0
165				1.8		1.6		1.6
170								

GMK4115

THIS CHART IS ONLY A GUIDE AND SHOULD NOT BE USED TO OPERATE THE CRANE. The individual crane's load chart, operating instructions and other instructional plates must be read and understood prior to operating the crane.

GROVE

working range

171' Main Boom with Manual Offset 32.8 ft. and 55.8 ft. Swingaway

20

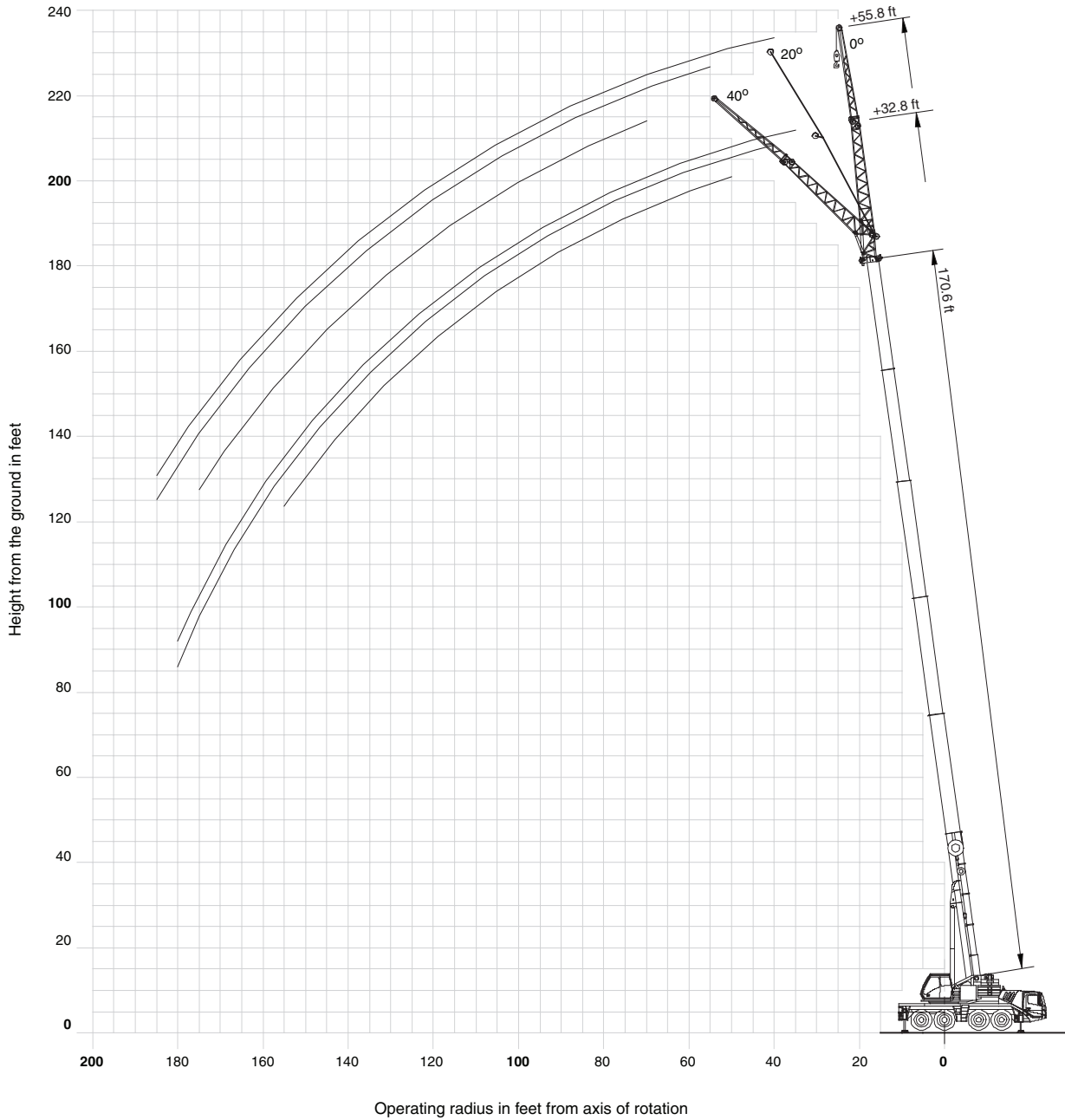

GMK4115

GROVE

THIS CHART IS ONLY A GUIDE AND SHOULD NOT BE USED TO OPERATE THE CRANE. The individual crane's load chart, operating instructions and other instructional plates must be read and understood prior to operating the crane.

working range

171' Main Boom with Manual Offset 55.8 ft. Swingaway and 2 x 16 ft. Inserts

21

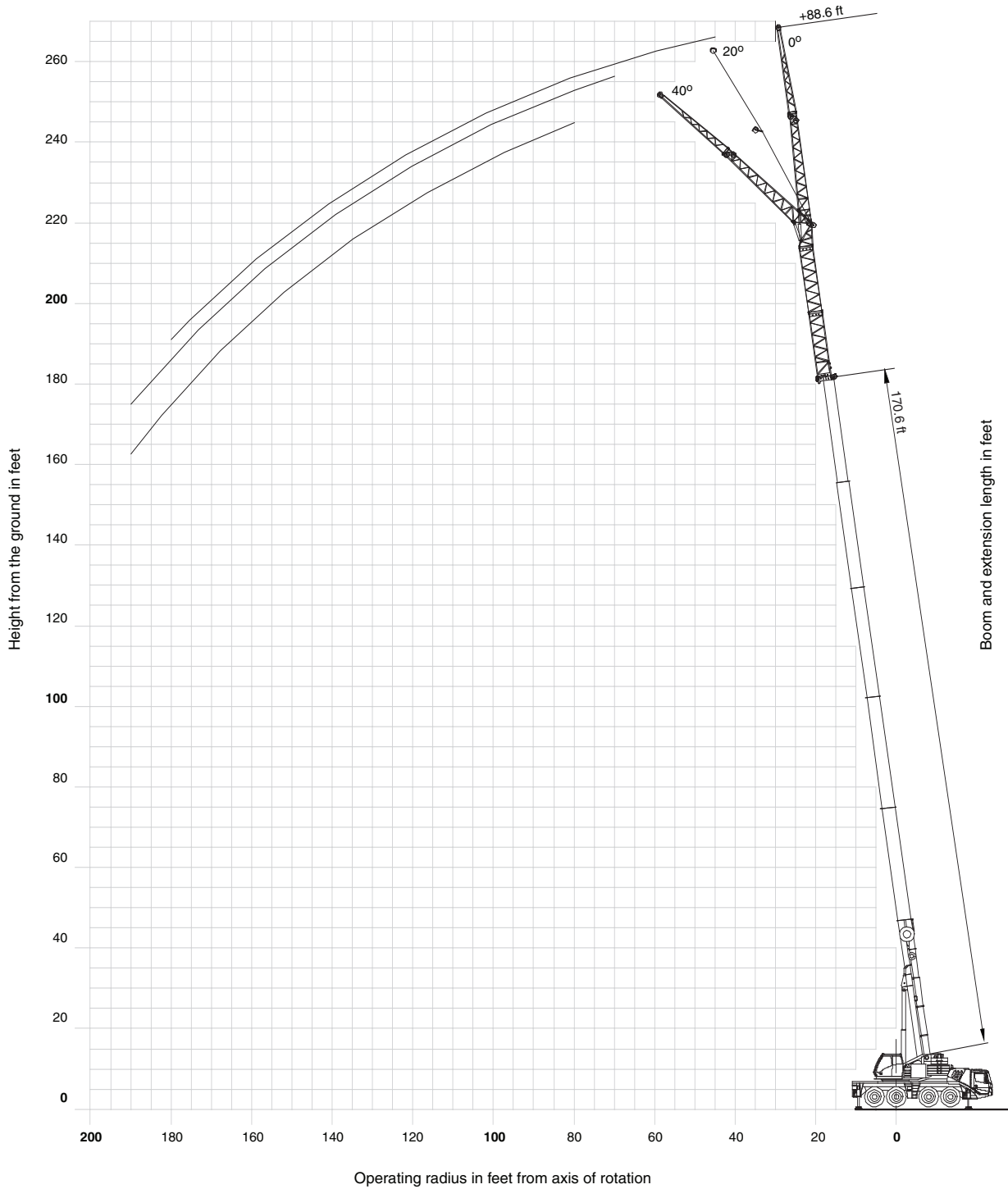

Boom and extension length in feet

GMK4115

THIS CHART IS ONLY A GUIDE AND SHOULD NOT BE USED TO OPERATE THE CRANE. The individual crane's load chart, operating instructions and other instructional plates must be read and understood prior to operating the crane.

GROVE

load charts

22



171 ft.
(52 m)



32.8-55.8-72.2-88.6 ft
(10-17-22-27 m)
Manual Offset



57,500 lbs.
(26 082 kg)



100%
23' spread



360°



Pounds x1000

Radius	170.6' + 32.8'			170.6' + 55.8'			170.6' + 72.2'			170.6' + 88.6'		
	0°	20°	40°	0°	20°	40°	0°	20°	40°	0°	20°	40°
35	10.8											
40	10.8	10.8		7.4			5.8					
45	10.8	10.8		7.4			5.8			4.0		
50	10.8	10.8	10.0	7.4			5.8			4.0		
55	10.8	10.8	10.0	7.7	7.4		5.8			4.0		
60	10.8	10.8	10.0	7.4	7.4		5.8	5.8		4.0		
65	10.8	10.8	10.0	7.4	7.4		5.8	5.8		4.0		
70	10.8	10.8	10.0	7.4	7.4	6.2	5.8	5.8		4.0	4.0	
75	10.8	10.8	10.0	7.4	7.4	6.2	5.8	5.8	5.6	4.0	4.0	
80	10.8	10.8	10.0	7.4	7.4	6.2	5.8	5.8	5.6	4.0	4.0	4.0
85	10.8	10.4	10.0	7.4	7.4	6.2	5.8	5.8	5.6	4.0	4.0	4.0
90	10.4	10.0	9.8	7.4	7.2	6.2	5.8	5.8	5.6	4.0	4.0	4.0
95	10.0	9.8	9.6	7.4	7.2	6.0	5.8	5.8	5.6	4.0	4.0	4.0
100	9.4	9.4	9.2	7.4	7.0	6.0	5.8	5.8	5.6	4.0	4.0	4.0
105	9.0	9.0	9.0	7.4	6.8	6.0	5.8	5.8	5.6	4.0	4.0	4.0
110	8.4	8.6	8.6	7.4	6.8	5.8	5.8	5.8	5.6	4.0	4.0	4.0
115	8.0	8.2	8.4	7.2	6.6	5.8	5.8	5.6	5.6	4.0	4.0	4.0
120	7.4	7.6	8.0	6.8	6.4	5.8	5.8	5.6	5.4	4.0	4.0	4.0
125	7.0	7.2	7.6	6.6	6.4	5.8	5.6	5.4	5.2	4.0	4.0	4.0
130	6.4	6.8	7.0	6.4	6.2	5.6	5.4	5.2	5.0	4.0	4.0	4.0
135	5.8	6.2	6.4	6.0	6.0	5.6	5.2	5.0	5.0	4.0	4.0	4.0
140	5.0	5.4	5.6	5.6	5.8	5.6	5.0	4.8	4.8	4.0	4.0	4.0
145	4.6	4.8	5.0	5.0	5.6	5.6	4.8	4.6	4.6	3.8	3.8	3.8
150	4.0	4.4	4.4	4.4	5.2	5.4	4.2	4.6	4.6	3.6	3.6	3.6
155	3.4	3.8	3.8	4.0	4.6	5.0	3.8	4.4	4.4	3.6	3.6	3.6
160	3.0	3.2		3.6	4.2	4.4	3.4	4.0	4.2	3.2	3.4	3.4
165	2.6	2.8		3.0	3.6	4.0	2.8	3.6	4.0	2.8	3.2	3.4
170	2.2	2.4		2.6	3.2	3.4	2.4	3.0	3.4	2.4	3.0	3.2
175	1.8	2.0		2.2	2.8	3.0	2.0	2.6	3.0	2.0	2.6	3.0
180	1.4	1.6		2.0	2.4		1.8	2.2	2.4	1.6	2.2	2.6
185				1.6	2.0			1.8	2.0		1.8	2.2
190					1.6			1.4	1.6		1.6	1.8

GMK4115

GROVE

THIS CHART IS ONLY A GUIDE AND SHOULD NOT BE USED TO OPERATE THE CRANE. The individual crane's load chart, operating instructions and other instructional plates must be read and understood prior to operating the crane.

load charts

23

171 ft.
(52 m)

32.8-55.8-72.2-88.6 ft
(10-17-22-27 m)
Manual Offset

52,600 lbs.
(23 859 kg)

100%
23' spread

360°



Pounds x1000

Radius	170.6' + 32.8'			170.6' + 55.8'			170.6' + 72.2'			170.6' + 88.6'		
	0°	20°	40°	0°	20°	40°	0°	20°	40°	0°	20°	40°
35	10.8											
40	10.8	10.8		7.4			5.8					
45	10.8	10.8		7.4			5.8			4.0		
50	10.8	10.8	10.0	7.4			5.8			4.0		
55	10.8	10.8	10.0	7.7	7.4		5.8			4.0		
60	10.8	10.8	10.0	7.4	7.4		5.8	5.8		4.0		
65	10.8	10.8	10.0	7.4	7.4		5.8	5.8		4.0		
70	10.8	10.8	10.0	7.4	7.4	6.2	5.8	5.8		4.0	4.0	
75	10.8	10.8	10.0	7.4	7.4	6.2	5.8	5.8	5.6	4.0	4.0	
80	10.8	10.8	10.0	7.4	7.4	6.2	5.8	5.8	5.6	4.0	4.0	4.0
85	10.8	10.4	10.0	7.4	7.4	6.2	5.8	5.8	5.6	4.0	4.0	4.0
90	10.4	10.0	9.8	7.4	7.2	6.2	5.8	5.8	5.6	4.0	4.0	4.0
95	10.0	9.8	9.6	7.4	7.2	6.0	5.8	5.8	5.6	4.0	4.0	4.0
100	9.4	9.4	9.2	7.4	7.0	6.0	5.8	5.8	5.6	4.0	4.0	4.0
105	9.0	9.0	9.0	7.4	6.8	6.0	5.8	5.8	5.6	4.0	4.0	4.0
110	8.4	8.6	8.6	7.4	6.8	5.8	5.8	5.8	5.6	4.0	4.0	4.0
115	7.6	8.2	8.4	7.2	6.6	5.8	5.8	5.6	5.6	4.0	4.0	4.0
120	7.0	7.4	7.8	6.8	6.4	5.8	5.8	5.6	5.4	4.0	4.0	4.0
125	6.2	6.8	7.0	6.6	6.4	5.8	5.6	5.4	5.2	4.0	4.0	4.0
130	5.6	6.0	6.4	6.0	6.2	5.6	5.4	5.2	5.0	4.0	4.0	4.0
135	5.0	5.4	5.6	5.4	6.0	5.6	5.0	5.0	5.0	4.0	4.0	4.0
140	4.4	4.8	5.0	4.8	5.6	5.6	4.6	4.8	4.8	4.0	4.0	4.0
145	3.8	4.2	4.4	4.2	5.0	5.6	4.0	4.6	4.6	3.8	3.8	3.8
150	3.2	3.6	3.8	3.8	4.4	5.0	3.6	4.2	4.6	3.4	3.6	3.6
155	2.8	3.2	3.2	3.4	4.0	4.4	3.2	3.8	4.2	3.0	3.6	3.6
160	2.4	2.6		2.8	3.4	3.8	2.6	3.4	3.8	2.6	3.2	3.4
165	2.0	2.2		2.4	3.0	3.2	2.2	3.0	3.2	2.2	2.8	3.2
170	1.6	1.8		2.0	2.6	2.8	1.8	2.4	2.8	1.8	2.4	2.8
175				1.6	2.2	2.4	1.6	2.0	2.4	1.4	2.0	2.4
180					1.8			1.6	2.0		1.6	2.0
185									1.4			1.6

GMK4115

THIS CHART IS ONLY A GUIDE AND SHOULD NOT BE USED TO OPERATE THE CRANE. The individual crane's load chart, operating instructions and other instructional plates must be read and understood prior to operating the crane.

GROVE

load charts

24



171 ft.
(52 m)



32.8-55.8-72.2-88.6 ft
(10-17-22-27 m)
Manual Offset



42,900 lbs.
(19 459 kg)



100%
23' spread



360°



Pounds x1000

Radius	170.6' + 32.8'			170.6' + 55.8'			170.6' + 72.2'			170.6' + 88.6'		
	0°	20°	40°	0°	20°	40°	0°	20°	40°	0°	20°	40°
35	10.8											
40	10.8	10.8		7.4			5.8					
45	10.8	10.8		7.4			5.8			4.0		
50	10.8	10.8	10.0	7.4			5.8			4.0		
55	10.8	10.8	10.0	7.7	7.4		5.8			4.0		
60	10.8	10.8	10.0	7.4	7.4		5.8	5.8		4.0		
65	10.8	10.8	10.0	7.4	7.4		5.8	5.8		4.0		
70	10.8	10.8	10.0	7.4	7.4	6.2	5.8	5.8		4.0	4.0	
75	10.8	10.8	10.0	7.4	7.4	6.2	5.8	5.8	5.6	4.0	4.0	
80	10.8	10.8	10.0	7.4	7.4	6.2	5.8	5.8	5.6	4.0	4.0	4.0
85	10.8	10.4	10.0	7.4	7.4	6.2	5.8	5.8	5.6	4.0	4.0	4.0
90	10.2	10.0	9.8	7.4	7.2	6.2	5.8	5.8	5.6	4.0	4.0	4.0
95	9.2	9.8	9.6	7.4	7.2	6.0	5.8	5.8	5.6	4.0	4.0	4.0
100	8.2	8.8	9.2	7.4	7.0	6.0	5.8	5.8	5.6	4.0	4.0	4.0
105	7.4	8.0	8.4	7.4	6.8	6.0	5.8	5.8	5.6	4.0	4.0	4.0
110	6.6	7.2	7.6	6.8	6.8	5.8	5.8	5.8	5.6	4.0	4.0	4.0
115	5.8	6.4	6.8	6.2	6.6	5.8	5.8	5.6	5.6	4.0	4.0	4.0
120	5.2	5.8	6.0	5.6	6.4	5.8	5.2	5.6	5.4	4.0	4.0	4.0
125	4.6	5.0	5.4	5.0	5.8	5.8	4.6	5.4	5.2	4.0	4.0	4.0
130	4.0	4.4	4.8	4.4	5.2	5.6	4.0	5.0	5.0	3.8	4.0	4.0
135	3.4	3.8	4.0	3.8	4.6	5.2	3.6	4.4	5.0	3.4	4.0	4.0
140	2.8	3.2	3.4	3.4	4.2	4.6	3.0	3.8	4.4	3.0	3.8	4.0
145	2.4	2.8	3.0	3.0	3.6	4.2	2.6	3.4	4.0	2.6	3.2	3.8
150	2.0	2.2	2.4	2.4	3.2	3.6	2.2	3.0	3.4	2.2	2.8	3.4
155	1.6	1.8	2.0	2.0	2.6	3.0	1.8	2.6	3.0	1.8	2.4	2.8
160				1.6	2.2	2.6		2.2	2.6		2.0	2.4
165					1.8	2.0		1.6	2.0		1.6	2.0
170						1.6			1.6			1.6

GMK4115

GROVE

THIS CHART IS ONLY A GUIDE AND SHOULD NOT BE USED TO OPERATE THE CRANE. The individual crane's load chart, operating instructions and other instructional plates must be read and understood prior to operating the crane.

Regional Headquarters

Americas

Manitowoc, Wisconsin, USA

Tel: +1 920 684 6621

Fax: +1 920 683 6278

Shady Grove, Pennsylvania, USA

Tel: +1 717 597 8121

Fax: +1 717 597 4062

Regional Offices

Americas

Brazil

Alphaville

Tel: +55 11 4688 2716

Fax: +55 11 8489 4671

Mexico

Monterrey

Tel: +52 81 8124 0128

Fax: +52 81 8124 0129

Europe, Middle East, Africa

Algers

Hydra

Tel: +21 3 21 48 1173

Fax: +21 3 21 48 1454

Czeck Republic

Netvorice

Tel: +420 317 78 9313

Fax: +420 317 78 9314

France

Baudemont

Tel: +33 385 28 2589

Fax: +33 385 28 0430

Cergy

Tel: +33 130 31 3150

Fax: +33 130 38 6085

Decines

Tel: +33 472 81 5000

Fax: +33 472 81 5010

Germany

Langenfeld

Tel: +49 21 73 8909-0

Fax: +49 21 73 8909 30

Hungary

Budapest

Tel: +36 13 39 8622

Fax: +36 13 39 8622

Italy

Parabiago

Tel: +390 331 49 3311

Fax: +390 331 49 3330

Europe, Middle East, Africa

Ecully, France

Tel: +33 472 18 2020

Fax: +33 472 18 2000

Netherlands

Breda

Tel: +31 76 578 3999

Fax: +31 76 578 3978

Poland

Warsaw

Tel: +48 22 843 3824

Fax: +48 22 843 3471

Portugal

Alfena

Tel: +351 229 69 8840

Fax: +351 229 69 8848

Lisbon

Tel: +351 212 109 340

Fax: +351 212 109 349

Russia

Moscow

Tel: +7 495 641 2359

Fax: +7 495 641 2358

U.A.E.

Dubai

Tel: +971 4 3381 861

Fax: +971 4 3382 343

U. K.

Middlesex

Tel: +44 1 895 43 0053

Fax: +44 1 895 45 9500

Sunderland

Tel: +44 191 522 2000

Fax: +44 191 522 2052

Asia – Pacific

Australia

Melbourne

Tel: +61 3 9 336 1300

Fax: +61 3 9 336 1322

Sydney

Tel: +61 2 9 896 4433

Fax: +61 2 9 896 3122

Asia – Pacific

Shanghai, China

Tel: +86 21 51113579

Fax: +86 21 51113578

Singapore

Tel: +65 6264 1188

Fax: +65 6862 4142

China

Beijing

Tel: +86 10 64671690

Fax: +86 10 64671691

Xi'an

Tel: +86 29 87891465

Fax: +86 29 87884504

Korea

Seoul

Tel: +82 2 508 3361

Fax: +82 2 508 3365

Phillipines

Makati City

Tel: +63 2 844 9437

Fax: +63 2 844 4712

Factories

U.S.A.

Manitowoc

Shady Grove

Brazil

Alphaville

France

Charlieu

La Clayette

Moulines

India

Calcutta

Puna

Italy

Niella Tanaro

Germany

Wilhelmshaven

Portugal

Fânzeres

China

Zhangjiagang

