

LS-248H II

HYLAB Series

Lattice Boom Crawler Crane 200-ton (181.44 mt)

- 200-ton (181.44 mt) at 10' (3.05 m) radius
- Maximum 280' (85.34 m) of conventional boom or 240' + 100' (73.15 + 30.48 m) of offsettable jib for 337' (102.72 m) tip height
- Luffer ready
- Maximum 190' (57.91 m) of luffing boom + 190' (57.91 m) of luffing jib and fixed jib for 380' (115.82 m) tip height
- All hydraulic power with fine inching control
- Self-assembly and disassembly (no helper crane required)
- Main transport load is 68,100 lbs (30 890 kg)
- Completely sealed lower
- Compact travel drives
- Ergonomic cab layout with arm chair controls
- 248 hp Isuzu engine
- Meets latest OSHA requirements for handling personnel



LS-248H II

HYLAB Series

Unbeatable hydraulic control system, luffing availability and maximum transportability

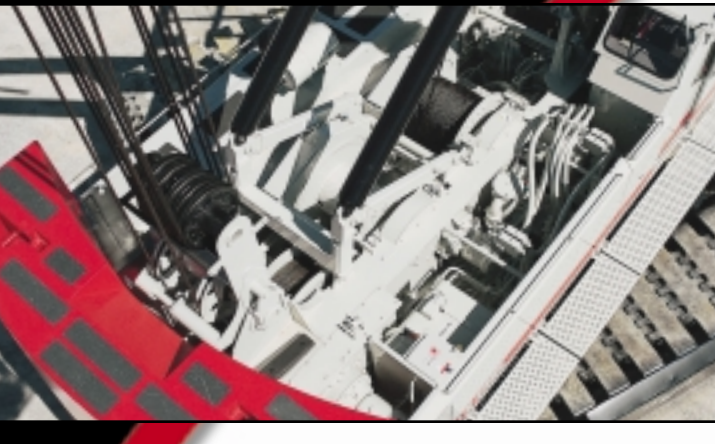

Seamless welds and treated hardware throughout attachment



248 hp Isuzu A-6SD1T-QB-01 engine



Counterweight tray, repositionable ladders and removal catwalks provide outstanding accessibility.



Hydraulic jacking system lifts the upper, lower frame and treadmembers off the ground. Treadmembers are removed and a trailer can then be backed under the lower frame and upper for transport.

Variable displacement hydraulic system provides maximum reliability and precise load control

- Two variable displacement piston pumps provide power to individual hydraulic motors for fast, efficient operation of main, auxiliary and boom hoist drums.
- Infinite control of load speed in hoist and lowering modes
- Maximum full load line speed of over 595 fpm (181.36 m/min)
- Fully independent hydraulic control allows drums to be run simultaneously at different speeds or in different directions.
- Selectable freefall or automatic brake mode of operation for load lowering
- All hydraulic power with fine inching control for super precise control of load lowering/hoisting, boom hoist or travel
- Optional third drum mounts in boom base
- Variable speed control of all functions
- Power up and power down on all drums
- Extra wide, equal size drums easily viewed from operator's control center
- Anti-two block system
- Swing alarm
- Mechanical drum rotation indicators
- Quiet 248 hp Isuzu A-6SD1T-QB-01 engine

Lower

- High flotation, extra-wide self-cleaning 44" (1.12 m) track shoes form a wide gauge of 23' 6" (7.16 m)
- Ball bearing turntable with two-position locking mechanism
- Sealed track rollers, idler and drive planetaries and compact hydrostatic drives add up to outstanding reliability and maintenance-free operation
- Side frame counterweights - 24,000 lbs (10 886 kg) each

Operator's cab

- Swing-up roof window with wiper
- Sliding front glass
- Six-way adjustable seat
- Hand and foot throttle
- Hand and foot-operated boom hoist control
- Pilot-operated arm chair single-axis control levers
- Swing lever with swing brake and horn located on handle
- PAT DS-350 rated capacity limiter

Attachment flexibility offers extended range

- 50' - 280' (15.24 - 85.34 m) conventional boom
- Optional auxiliary 5' (1.5 m) tip extension designed to provide clearance between two working hoist lines
- 40' - 100' (12.19 - 30.48 m) tube jib, offsettable at 5°, 15° or 25°
- 42.5-ton (38.5 m) capacity, 380' (115.82 m) luffing attachment with 360° capacities, utilizing conventional boom for luffing boom

Move quickly from job to job

- Self-stripdown capabilities - no helper crane needed
- Counterweights can be removed and installed using the crane's live mast or the optional 10' (3.05 m) boom extension with lifting sheaves
- Handling sling — standard
- Lower frame jacking cylinders lifts the upper, lower frame and treadmembers off the ground to quickly load for transport
- Moves in eight loads with full boom, jib and counterweight



Optional 10' (3.05 m) boom extension handles treadmembers, counterweight and boom during self-stripdown or erection.



Specifications

Hydraulic Lattice Boom Crawler Crane

LS-248H II

200-Ton (181.50 metric ton)

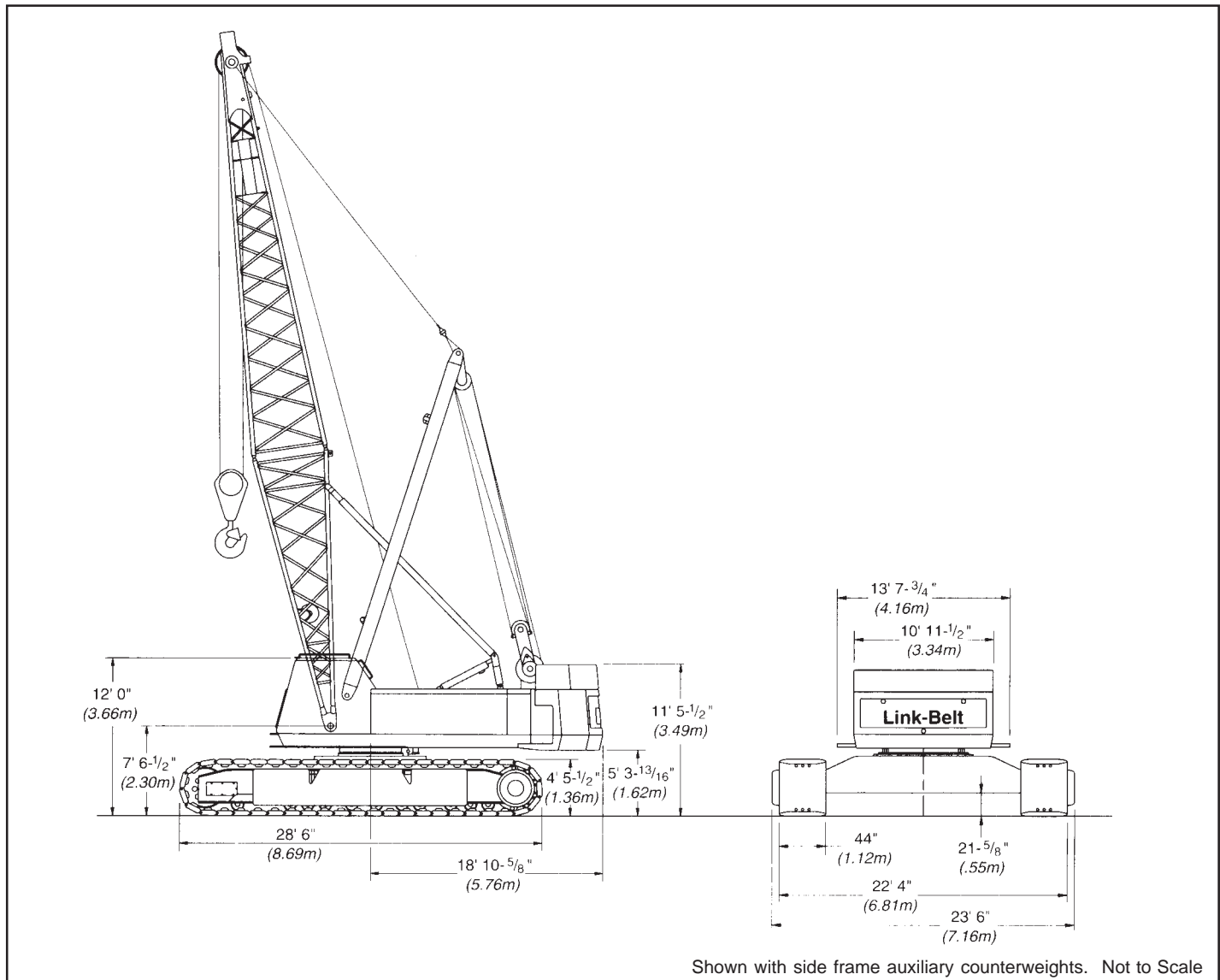

General dimensions	feet	meters
Basic boom length	50	15.24
Overall width of machine with 44" (1.12 m) track shoes	22.5	6.85
Overall width of cab w/catwalks both sides	13.64	4.15
Overall width of cab less catwalks	10.95	3.34

General dimensions	feet	meters
Tailswing of counterweight "A"	16.80	5.12
Tailswing of counterweight "AB"	18.89	5.76
Tailswing of counterweight "ABC"	18.89	5.76
Overall height for transport w/boom base	13.31	4.05
Overall height for transport w/live mast only	13.31	4.05

Machine Working Weights - approximate

Based on standard machine with Isuzu A-6SD1TQB-01 diesel engine, turntable bearing, independent hydraulic powered drums, boomhoist limiting device, independent hydraulic swing and travel, swing brake, drum rotation indicators, and 18' 10" (5.74 m) gauge by 28' 6" (8.69 m) long crawler lower with 44" (1.12 m) wide track shoes, track rollers with dirt seals, 48,000 lb. (21 772 kg) side frame auxiliary counterweights, catwalks, hydraulic boomfoot pin removal, plus the following:	Equipped with upper ctwt. "A" + side frame ctwts.		Equipped with upper ctwt. "AB" + side frame ctwts.		Equipped with upper ctwt. "ABC" + side frame ctwts.	
	lbs.	kg	lbs.	kg	lbs.	kg
Lifting Crane - includes 50' (15.24 m) basic tubular boom, 30' (9.14 m) live mast, 1,050' (320.04 m) of 1" (25 mm) diameter wire rope, 715' (217.93 m) of 7/8" (22 mm) diameter boomhoist rope, 175-ton (159 mt) hookblock, and basic pendants.	224,560	101 860	269,300	122 154	298,260	135 290

Transport Weights and Dimensions - ±3%

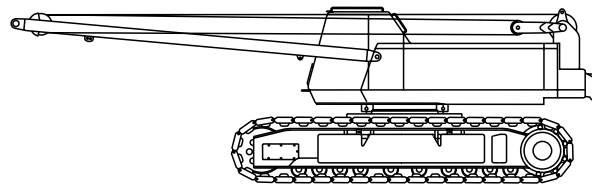

Assembly Weight
166,700 lbs. (75 615 kg)

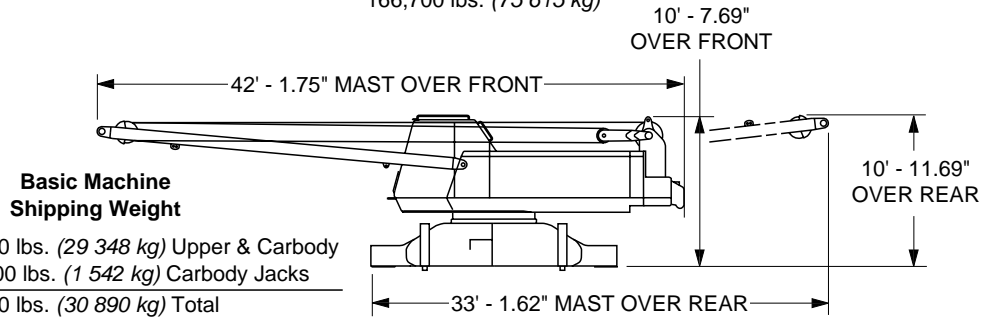
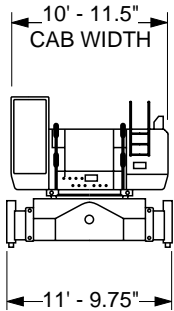

Basic Machine Shipping Weight
64,700 lbs. (29 348 kg) Upper & Carbody
+ 3,400 lbs. (1 542 kg) Carbody Jacks
68,100 lbs. (30 890 kg) Total

"C" Upper Counterweight
28,960 lbs. (13 136 kg)

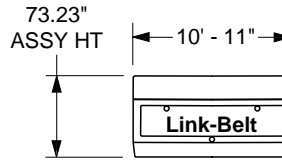
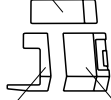

"ABC" Counterweight Assembly

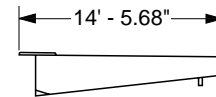

Counterweight Assist Frame
4,900 lbs. (2 223 kg)
(not included in basic machine weight)

"A" Upper Counterweight
22,730 lbs. (10 310 kg)

"B" Upper Counterweight
44,740 lbs. (20 294 kg)

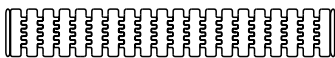
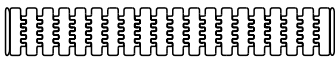

Tread Members
36,600 lbs. (16 602 kg) each

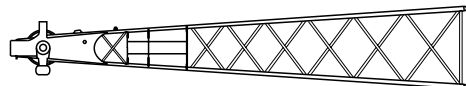

30' (9.14 m) Peak Section
4,130 lbs. (1 873 kg)

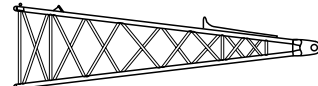

20' (6.10 m) Base Section
4,650 lbs. (2 109 kg) - w/o third drum winch assembly
9,830 lbs. (4 459 kg) - w/third drum winch assembly

68" x 80" cross-section tubular boom

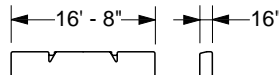

Side Frame Auxiliary Counterweights (2)
24,000 lbs. (10 886 kg) each
(not included in basic machine weight)

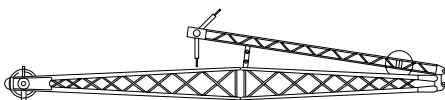

30' (9.14 m) Jib Assembly
1,900 lbs. (862 kg)

Optional Boom Sections	
10' (3.05 m) boom extension	840 lbs. (381 kg)
20' (6.10 m) boom extension	1,680 lbs. (762 kg)
30' (9.14 m) boom extension	2,520 lbs. (1 143 kg)
40' (12.19 m) boom extension	3,360 lbs. (1 524 kg)

Crawler Mounting

■ Lower frame

All welded high strength steel (100,000 psi yield), box construction; precision machined surfaces for turntable bearing and axle plates.

■ Turntable bearing

Outer race bolted to lower frame; inner race with internal swing gear bolted to upper.

■ Crawler side frames

All welded, precision machined and removable. Each side frame comes with lifting brackets. Positioned on cross axles by dowels and held in place with adjustable wedgepacks.

■ Crawler side frame auxiliary counterweights

Removable 24,000 lb. (10 886 kg) auxiliary counterweight on each crawler side frame.

■ Track drive sprockets

Cast steel, heat treated; self-cleaning and sealed for lifetime lubrication. Powered by hydraulic motor(s) through double reduction gear drive.

■ Track carrier slide rails

Slide rails on top of each side frame.

■ Track rollers

Heat treated, oil filled, mounted on "sealed for life" anti-friction bearings; 12 per side crawler side frame.

■ Tracks

Heat treated, self-cleaning, multiple hinged track shoes joined by one piece full floating pins; 51 shoes per side frame - 44" (1.12 m) wide.

Track tension adjustment - Idler wheel adjusted by means of hydraulic cylinder and hand pump. Idler wheel shaft held in position with shims after adjustment is made.

■ Take up idlers

Cast steel, heat treated, self-cleaning, mounted on aluminum/bronze bushings. Lubricated through idler shaft.

■ Independent hydraulic travel/steering

Power transmitted by axial piston hydraulic motors through planetary gear reduction unit to track drive sprocket.

Steering - Axial piston motor with reduction gear is located at inner drive end of each crawler side frame. Each track is driven simultaneously or individually for straight-line, gradual turn, or pivot turn. The tracks can be counterrotated for spin turns.

Brakes - Spring applied, hydraulically released multiple disc brakes are applied automatically when the control lever is in the neutral position.

Travel speed - 0 - .50 mph (0 - 0.80 km/hr).
Gradeability - 30%

■ Jacking system

Optional; four ground controlled, power hydraulic jacks, pinned to the lower carbody frame, used to raise the machine to facilitate removal or installation of the crawler side frames.

Ground contact area and ground bearing pressure

Based on standard machine equipped with "ABC" counterweight and 50' (15.24 m) tubular boom.

Track shoes		Ground contact area		Ground bearing pressure	
inches	meters	sq. in.	cm ²	psi	kg/cm ²
44	1.12	12,760	82 328	11.6	0.82

Revolving Upperstructure

■ Frame

All welded and precision machined.

■ Turntable bearing

With integral swing (ring) gear. Inner race with internal swing gear is bolted to upper revolving frame; outer race is bolted to machined surface on lower.

■ Engine

Full pressure lubrication, oil filter, air cleaner, hour meter and throttle, electric control shutdown.

■ Fuel tank

77 gallon (291 liter) capacity; equipped with fuel sight level gauge, flame arrester, and self-closing cap with locking eye for padlock.

Engine Specifications	Isuzu A-6SD1TQB-01
Number of cylinders	6
Bore and stroke: inch - (mm)	4.72 x 5.71 (120 x 145)
Piston displacement - cu. in. - (cm ³)	600 (9 839)
High idle speed - rpm	2,400
Engine rpm at full load speed	2,200
Net engine hp at full load speed	237
Peak torque - foot pounds - joules	644 (873.3)
Peak torque - rpm	1,500
Electrical system	24-volt
Batteries	2 - 12 volt

LS-248H II Load Hoisting Performance

Available line speed and line pull

Line pulls are not based on wire rope strength. See wire rope chart below for maximum permissible single part of line working loads.

Line Speeds and Pulls

Rope layer	Front Drum - 1" (25 mm) wire rope						Rear Drum - 1" (25 mm) wire rope					
	Maximum line pull		No load line speed		Full load line speed		Maximum line pull		No load line speed		Full load line speed	
	lbs.	kg	ft./min	m/min	ft./min	m/min	lbs.	kg	ft./min	m/min	ft./min	m/min
1	48,620	22 055	225	68.5	112	34.2	29,360	13 318	372	113.4	186	56.7
2	44,200	20 050	247	75.3	124	37.7	26,690	12 108	409	124.8	205	62.4
3	40,510	18 379	270	82.2	135	41.1	24,470	11 099	446	136.1	223	68.0
4	37,400	16 965	292	89.0	146	44.5	22,590	10 245	484	147.5	242	73.7
5	34,720	15 753	315	95.9	157	47.9	20,970	9 513	521	158.8	260	79.4
6	32,410	14 703	337	102.7	168	51.3	19,570	8 877	558	170.1	279	85.1
7	30,390	13 784	359	109.6	179	54.7	18,350	8 324	595	181.5	298	90.7

Rope layer	Boomhoist Drum - 7/8" (22 mm) wire rope						Third Drum - 1" (25 mm) wire rope					
	Maximum line pull		No load line speed		Full load line speed		Maximum line pull		No load line speed		Full load line speed	
	lbs.	kg	ft./min	m/min	ft./min	m/min	lbs.	kg	ft./min	m/min	ft./min	m/min
1	40,842	18 526	147	44.9	134	40.8	20,656	9 369	442	135	105	32
2	36,760	16 674	163	49.8	149	45.3	18,752	8 506	486	148	116	35
3	33,417	15 158	180	54.8	163	49.8	17,169	7 788	531	162	127	39
4	30,633	13 895	196	59.8	178	54.4	15,833	7 182	576	176	138	42
5	28,276	12 826	213	64.8	193	58.9	14,690	6 663	621	189	148	45
6	26,257	11 910	229	69.7	208	63.4	--	--	--	--	--	--
7	24,506	11 116	245	74.7	223	67.9	--	--	--	--	--	--

Wire Rope Drum Capacities

Rope layer	Boomhoist Drum Capacity - 7/8" (22 mm) rope					
	Pitch Diameter		Layer		Total	
	in.	mm	ft.	m	ft.	m
1	15.88	403.2	51.8	15.8	51.8	15.8
2	17.63	447.7	57.1	17.4	108.9	33.2
3	19.38	492.1	62.3	19.0	171.2	52.2
4	21.13	536.6	67.2	20.5	238.5	72.7
5	22.88	581.0	72.5	22.1	311.0	94.8
6	24.63	625.5	77.4	23.6	388.4	118.4
7	26.38	669.9	82.7	25.2	471.1	143.6

Rope layer	Front Drum Capacity - 1" (25 mm) wire rope					
	Pitch Diameter		Layer		Total	
	in.	mm	ft.	m	ft.	m
1	20	508	113	34.3	113	34.3
2	22	559	123	37.4	235	71.7
3	24	610	133	40.4	368	112.1
4	26	660	142	43.4	510	155.5
5	28	711	153	46.5	663	202.0
6	30	762	163	49.6	825	251.6
7	32	813	173	52.6	998	304.2

Rope layer	Rear Drum Capacity - 1" (25 mm) wire rope					
	Pitch Diameter		Layer		Total	
	in.	mm	ft.	m	ft.	m
1	20	508	113	34.3	113	34.3
2	22	559	123	37.4	235	71.7
3	24	610	133	40.4	368	112.1
4	26	660	142	43.4	510	155.5
5	28	711	153	46.5	663	202.0
6	30	762	163	49.6	825	251.6
7	32	813	173	52.6	998	304.2

Rope layer	Third Drum Capacity - 1" (25 mm) wire rope					
	Pitch Diameter		Layer		Total	
	in.	mm	ft.	m	ft.	m
1	19.7	500	150	45.8	150	45.8
2	21.7	551	165	50.4	316	96.2
3	23.7	602	181	55.1	496	151.3
4	25.7	653	196	59.7	692	211.0
5	27.7	704	211	64.4	903	275.3
6	29.7	754	226	68.9	1,129	344.1

Wire Rope: size, type and working strength

Wire rope application	Size: diameter		Type	Max. permissible load	
	inches	mm		lbs.	kg
Boomhoist	7/8	22	LB	25,000	11 340
Main load hoist	1	25	N	29,500	13 400
Jib load hoist (1-part)	1	25	RB	22,760	10 320
Jib load hoist (2-parts)	1	25	RB	45,520	20 640
Boom pendants (dual)	1	25	N	69,000	31 300
Jib staylines	7/8	22	N	26,550	12 040

Wire Rope: types available

- Type "N" - 6 x 25 (6 x 19 class) filler wire, extra improved plow steel, preformed, independent wire rope center, right lay, regular lay.
- Type "LB" - 6 x 25 (6 x 19 class) filler wire, preformed, independent wire rope center, right lay, regular lay.
- Type "RB" - 19 x 19 non-rotating, extra, extra improved plow steel, preformed, right regular lay, swaged.

Hydraulic System

Hydraulic pumps

Two variable displacement piston pumps operating at 4,000 psi (281.24 kg/cm²) power travel, main drum, auxiliary drum, third drum, and boomhoist functions. Two fixed displacement gear pumps operating at 3,000 psi (211 kg/cm²) power swing, counterweight lowering, and machine jack functions. One fixed displacement gear pump operating at 1,210 psi (85 kg/cm²) powers pilot control system, clutches, brakes, and pump controls.

"Fine Inching" pump control mode

Special fine metering pump setting selectable from the operator's cab allows very slow movements for precision work. Main hoist, auxiliary hoist, boomhoist, third drum, and travel are all supplied with this standard feature.

Hydraulic reservoir

42 gal. (159 L), equipped with sight level gauge.

Relief valves

Each function is equipped with relief valves to protect the circuit from overload or shock.

Brake valves

Travel circuit is provided with brake valves for all terrain capability.

Hydraulic filtration

Ten micron, full flow line filter furnished in control circuit. All oil is filtered prior to return to sump tank.

Hydraulic motors

Main hoist drum, auxiliary hoist drum, boomhoist, swing, and travel are powered by axial piston motors.

Counterbalance valves

Upper - Hoist motors are equipped with counterbalance valves to provide positive load lowering and prevent accidental load drop when hydraulic power is suddenly reduced.

Lower - Travel motors equipped with counterbalance valve to prevent over-speeding of motors when traveling down an incline.

Principal Operating Functions

Control system

Remote controlled hydraulic servo for main drum and auxiliary drum. Mechanical linkage controls swing. Function speed is proportional to lever movement. Levers are adjustable for operator comfort.

Load hoisting and lowering

Main and auxiliary hoist drums are driven by individual axial piston motors and reduction gearing. Load hoisting or lowering is provided by actuating or reversing a hydraulic motor. The control lever provides two speeds for hoisting and lowering. Hoisting or lowering speeds are proportional to lever movement.

Freefall - The incorporation of power hydraulic controlled, two-shoe clutches allow freefall operation of the main and auxiliary hoist drums for high cycle crane and duty cycle application. Mode selection switch on control panel allows operator to select the most productive operation mode.

Load hoist drums

Main (front) and auxiliary (rear) hoist drums are 19" (.48 m) root diameter grooved for 1" (25 mm) wire rope. Mounted on anti-friction bearings.

Third operating drum - *Optional*; 12-1/2" (.32 m) grooved drum lagging, mounted in boom base section.

Drum clutches

Speed-o-Matic® power hydraulic two-shoe clutches; internal expanding, lined shoes. Clutch spiders are splined to shafts; clutch drums are integral with hoist drums.

Load hoist clutches - Front and rear main drums - clutch drums 30" (.76 m) diameter, 6-1/2" (.17 m) width.

Drum brakes

External contracting band type; operated by foot pedal equipped with a locking latch. Operator may select automatic brake mode* (spring applied, hydraulically released), which will apply brakes when the hoist control lever is in the neutral position.

*When in the automatic brake mode, the LS-248H II meets all OSHA requirements for personnel handling.

Drum rotation indicators

Standard for front and rear drums. Audible-type indicators.

Drum locking pawl

Standard for front and rear drums; electrically actuated and prevents drum rotation in a lowering direction.

Anti two-block system

Standard - A switch mounted on the boom peak activates a buzzer to warn the operator of a two-block condition and simultaneously disengages hoist function while applying the hoist brakes.

Swing system

Independent, hydraulic swing is driven by two axial piston motors through a gear reduction system; free swing when lever is in neutral position.

Swing brake - Spring applied, hydraulically released; controlled by button on swing control lever.

Swing lock - Mechanically controlled, two-position locking mechanism.

Optional - 360° locking mechanism available to meet New York City code.

Swing speed - Variable from 0 to 2 rpm.

Boomhoist/lowering system

Independent, hydraulic boomhoist is driven by an axial piston motor through a gear reduction system. Boom hoisting or lowering is performed by actuating or reversing the motor. Boomhoist speed is infinitely variable. Boomhoist speed from 0° to 70° boom angle is 90 seconds.

Boomhoist drum

Single grooved lagging 15" (.38 m) root diameter.

Boomhoist drum locking pawl

Electrically operated.

Boomhoist brake

Spring applied, hydraulically released, multiple disc type brake. Brake is automatically applied when control lever is in neutral position.

Boomhoist limiting device - Restricts hoisting boom beyond recommended minimum radius.

■ Electrical system

24 volt negative ground system with two 12-volt batteries. Standard lighting system includes: two 70 watt headlights mounted on machine front and one interior cab light.

■ Operator's cab

Full vision, modular compartment with safety glass panels. The completely independent cab is insulated against noise and vibration. Sliding operator's door, swing up roof window. Standard equipment includes: heater, air conditioner, defroster, windshield wiper, dry chemical fire extinguisher, sun visor, bubble-type level, fuel gauge, tachometer, hydraulic temperature gauge, engine oil pressure gauge, coolant temperature gauge, and service monitor system.

■ Machinery cab

Hinged doors (one on right side, two on left side) for machinery access. Equipped with rooftop access ladder, electric warning horn and skid resistant finish on roof.

■ Catwalks

Standard on right and left sides. Catwalks remove for reduced travel width.

■ Bail

Pinned to revolving frame. Seven sheaves are provided for 16 part boomhoist wire rope reeving. Sheaves mounted on "lifetime sealed" anti-friction bearings.

■ Counterweights

"A" upper ctwt. - 22,730 lb. (10 310 kg)

"AB" upper ctwt. - 67,470 lb. (30 604 kg)

"ABC" upper ctwt. - 96,430 lb. (43 741 kg)

Side frame ctwts. - see side frame auxiliary ctwt. description under Crawler Mounting on page 3.

Boom and Jib

■ Tubular boom

Two-piece basic boom 50' (15.24 m) long with open throat top section. Boom 80" (2.03 m) wide, 68" (1.73 m) deep at connections. Alloy steel round tubular cords 4" (.10 m) outside diameter. Maximum boom length is 280' (85.34 m).

■ Base section

20' (6.10 m) long; boomfeet on 55" (1.40 m) centers.

■ Boom extensions

Available in 10', 20', 30' and 40' (3.05, 6.10, 9.14 and 12.19 m) lengths with appropriate length pendants.

■ Boom connections

In-line pin connections.

■ Boom top section

Open throat; 30' (9.14 m) long.

■ Boompoint machinery

Six 21" (.53 m) root diameter sheaves mounted on "lifetime sealed" anti-friction bearings.

■ Hydraulic boomfoot pin removal

Standard; Speed-o-Matic controlled; located between mounting lugs on boom base section.

■ Boom live mast

30' (9.14 m) long; supports boomhoist bridle and boom pendants. Required for all boom lengths. May be used as short boom for assembling and disassembly of side frames and boom, but is not intended for general crane service. Refer to operator's manual for boom live mast lifting capacities.

■ Jib

Tubular; two-piece basic jib 30' (9.14 m) long; 32" (.81 m) wide, 24" (.61 m) deep at centerline of connections. Alloy steel tubular chords 2-1/4" (57 mm) outside diameter.

Base section - 13' 3" (4.04 m) long.

Jib extensions - Available in 10' (3.05 m) and 20' (6.10 m) lengths with appropriate length pendants.

Jib connections - In-line, tapered pins.

Tip section - 15' (4.57 m) long; equipped with single peak sheave 21" (.53 m) root diameter, heat treated and mounted on anti-friction bearings. Anchor provided at peak of jib tip section for two-part load hoist wire rope (whipline) connection.

Maximum jib length permitted - 100' (30.48 m). All jib lengths may be mounted at 5°, 15°, or 25° offset to boom.

■ Jib mast

17' 10" (5.44 m) long, mounted on jib base section. Two deflector sheaves mounted within mast to guide whipline; mounted on anti-friction bearings. Two equalizer sheaves mounted on top of mast - one for jib frontstay line, one for jib backstay line.

Jib staylines - Front and back staylines. Back staylines vary in length depending on degree of jib offset from boom centerline; back staylines attached at bottom end of boom top section.

Jib stops - Telescoping type; pinned from jib mast to boom top section and from jib mast to jib base section.

Auxiliary Equipment

■ Boom angle indicator

Pendulum type; mounted on boom base section. Electronic type readout on load indicator.

■ Hook blocks

Blocks, or weighted ball with swivel hook, *optional* - refer to price list.

■ Rated capacity limiter

Standard; PAT DS-350 rated capacity limiter, programmed with multiple charts, provides the operator with: main boom length, main boom angle, jib angle, jib length, operating mode, load radius, boom tip height, anti-two block indicator, pre-warning light, audible alarm, overload light, and load on hook.

■ Swing alarm

Standard; audio/visual warning device signals when upper is swinging.

■ Lifting slings

For handling side frames and auxiliary side frame counterweights.

This page intentionally blank



Specifications

Hydraulic Lattice Boom Crawler Crane

LS-248H II

200-Ton (181.50 metric ton)

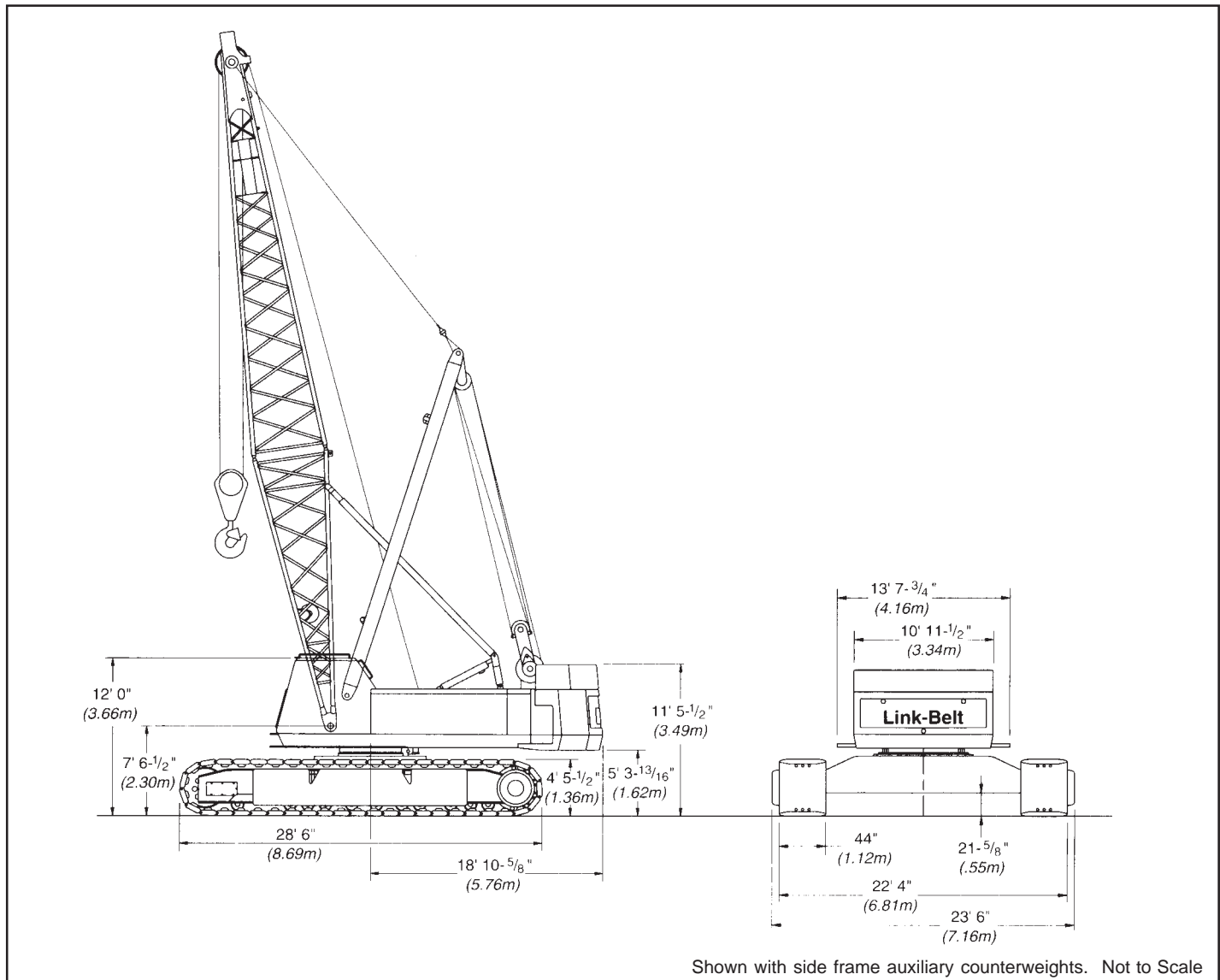

General dimensions	feet	meters
Basic boom length	50	15.24
Overall width of machine with 44" (1.12 m) track shoes	22.5	6.85
Overall width of cab w/catwalks both sides	13.64	4.15
Overall width of cab less catwalks	10.95	3.34

General dimensions	feet	meters
Tailswing of counterweight "A"	16.80	5.12
Tailswing of counterweight "AB"	18.89	5.76
Tailswing of counterweight "ABC"	18.89	5.76
Overall height for transport w/boom base	13.31	4.05
Overall height for transport w/live mast only	13.31	4.05

Machine Working Weights - approximate

Based on standard machine with Isuzu A-6SD1TQB-01 diesel engine, turntable bearing, independent hydraulic powered drums, boomhoist limiting device, independent hydraulic swing and travel, swing brake, drum rotation indicators, and 18' 10" (5.74 m) gauge by 28' 6" (8.69 m) long crawler lower with 44" (1.12 m) wide track shoes, track rollers with dirt seals, 48,000 lb. (21 772 kg) side frame auxiliary counterweights, catwalks, hydraulic boomfoot pin removal, plus the following:	Equipped with upper ctwt. "A" + side frame ctwts.		Equipped with upper ctwt. "AB" + side frame ctwts.		Equipped with upper ctwt. "ABC" + side frame ctwts.	
	lbs.	kg	lbs.	kg	lbs.	kg
Lifting Crane - includes 50' (15.24 m) basic tubular boom, 30' (9.14 m) live mast, 1,050' (320.04 m) of 1" (25 mm) diameter wire rope, 715' (217.93 m) of 7/8" (22 mm) diameter boomhoist rope, 175-ton (159 mt) hookblock, and basic pendants.	224,560	101 860	269,300	122 154	298,260	135 290

Transport Weights and Dimensions - ±3%

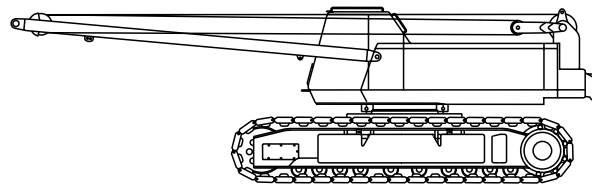

Assembly Weight
166,700 lbs. (75 615 kg)

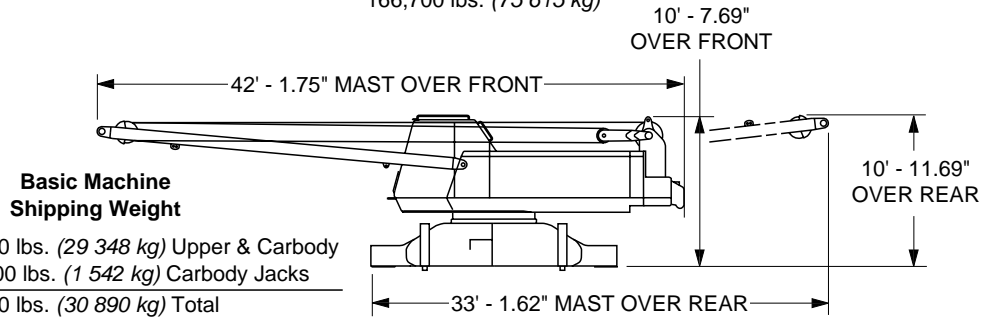
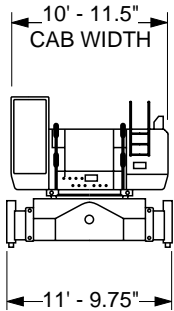

Basic Machine Shipping Weight
64,700 lbs. (29 348 kg) Upper & Carbody
+ 3,400 lbs. (1 542 kg) Carbody Jacks
68,100 lbs. (30 890 kg) Total

"C" Upper Counterweight
28,960 lbs. (13 136 kg)

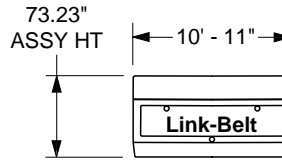

"ABC" Counterweight Assembly

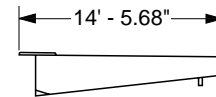

Counterweight Assist Frame
4,900 lbs. (2 223 kg)
(not included in basic machine weight)

"A" Upper Counterweight
22,730 lbs. (10 310 kg)

"B" Upper Counterweight
44,740 lbs. (20 294 kg)

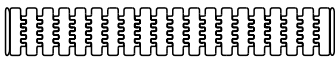

Tread Members
36,600 lbs. (16 602 kg) each

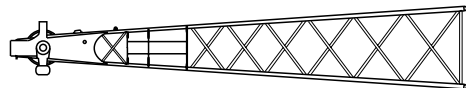
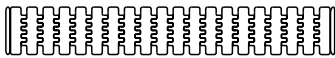

30' (9.14 m) Peak Section
4,130 lbs. (1 873 kg)

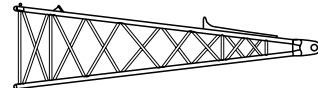

20' (6.10 m) Base Section
4,650 lbs. (2 109 kg) - w/o third drum winch assembly
9,830 lbs. (4 459 kg) - w/third drum winch assembly

68" x 80" cross-section tubular boom

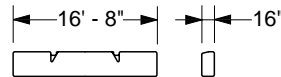

Side Frame Auxiliary Counterweights (2)
24,000 lbs. (10 886 kg) each
(not included in basic machine weight)

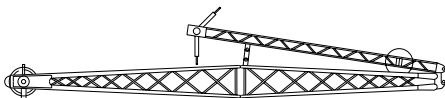

30' (9.14 m) Jib Assembly
1,900 lbs. (862 kg)

Optional Boom Sections	
10' (3.05 m) boom extension	840 lbs. (381 kg)
20' (6.10 m) boom extension	1,680 lbs. (762 kg)
30' (9.14 m) boom extension	2,520 lbs. (1 143 kg)
40' (12.19 m) boom extension	3,360 lbs. (1 524 kg)

Crawler Mounting

■ Lower frame

All welded high strength steel (100,000 psi yield), box construction; precision machined surfaces for turntable bearing and axle plates.

■ Turntable bearing

Outer race bolted to lower frame; inner race with internal swing gear bolted to upper.

■ Crawler side frames

All welded, precision machined and removable. Each side frame comes with lifting brackets. Positioned on cross axles by dowels and held in place with adjustable wedgepacks.

■ Crawler side frame auxiliary counterweights

Removable 24,000 lb. (10 886 kg) auxiliary counterweight on each crawler side frame.

■ Track drive sprockets

Cast steel, heat treated; self-cleaning and sealed for lifetime lubrication. Powered by hydraulic motor(s) through double reduction gear drive.

■ Track carrier slide rails

Slide rails on top of each side frame.

■ Track rollers

Heat treated, oil filled, mounted on "sealed for life" anti-friction bearings; 12 per side crawler side frame.

■ Tracks

Heat treated, self-cleaning, multiple hinged track shoes joined by one piece full floating pins; 51 shoes per side frame - 44" (1.12 m) wide.

Track tension adjustment - Idler wheel adjusted by means of hydraulic cylinder and hand pump. Idler wheel shaft held in position with shims after adjustment is made.

■ Take up idlers

Cast steel, heat treated, self-cleaning, mounted on aluminum/bronze bushings. Lubricated through idler shaft.

■ Independent hydraulic travel/steering

Power transmitted by axial piston hydraulic motors through planetary gear reduction unit to track drive sprocket.

Steering - Axial piston motor with reduction gear is located at inner drive end of each crawler side frame. Each track is driven simultaneously or individually for straight-line, gradual turn, or pivot turn. The tracks can be counterrotated for spin turns.

Brakes - Spring applied, hydraulically released multiple disc brakes are applied automatically when the control lever is in the neutral position.

Travel speed - 0 - .50 mph (0 - 0.80 km/hr).
Gradeability - 30%

■ Jacking system

Optional; four ground controlled, power hydraulic jacks, pinned to the lower carbody frame, used to raise the machine to facilitate removal or installation of the crawler side frames.

Ground contact area and ground bearing pressure

Based on standard machine equipped with "ABC" counterweight and 50' (15.24 m) tubular boom.

Track shoes		Ground contact area		Ground bearing pressure	
inches	meters	sq. in.	cm ²	psi	kg/cm ²
44	1.12	12,760	82 328	11.6	0.82

Revolving Upperstructure

■ Frame

All welded and precision machined.

■ Turntable bearing

With integral swing (ring) gear. Inner race with internal swing gear is bolted to upper revolving frame; outer race is bolted to machined surface on lower.

■ Engine

Full pressure lubrication, oil filter, air cleaner, hour meter and throttle, electric control shutdown.

■ Fuel tank

77 gallon (291 liter) capacity; equipped with fuel sight level gauge, flame arrester, and self-closing cap with locking eye for padlock.

Engine Specifications	Isuzu A-6SD1TQB-01
Number of cylinders	6
Bore and stroke: inch - (mm)	4.72 x 5.71 (120 x 145)
Piston displacement - cu. in. - (cm ³)	600 (9 839)
High idle speed - rpm	2,400
Engine rpm at full load speed	2,200
Net engine hp at full load speed	237
Peak torque - foot pounds - joules	644 (873.3)
Peak torque - rpm	1,500
Electrical system	24-volt
Batteries	2 - 12 volt

LS-248H II Load Hoisting Performance

Available line speed and line pull

Line pulls are not based on wire rope strength. See wire rope chart below for maximum permissible single part of line working loads.

Line Speeds and Pulls

Rope layer	Front Drum - 1" (25 mm) wire rope						Rear Drum - 1" (25 mm) wire rope					
	Maximum line pull		No load line speed		Full load line speed		Maximum line pull		No load line speed		Full load line speed	
	lbs.	kg	ft./min	m/min	ft./min	m/min	lbs.	kg	ft./min	m/min	ft./min	m/min
1	48,620	22 055	225	68.5	112	34.2	29,360	13 318	372	113.4	186	56.7
2	44,200	20 050	247	75.3	124	37.7	26,690	12 108	409	124.8	205	62.4
3	40,510	18 379	270	82.2	135	41.1	24,470	11 099	446	136.1	223	68.0
4	37,400	16 965	292	89.0	146	44.5	22,590	10 245	484	147.5	242	73.7
5	34,720	15 753	315	95.9	157	47.9	20,970	9 513	521	158.8	260	79.4
6	32,410	14 703	337	102.7	168	51.3	19,570	8 877	558	170.1	279	85.1
7	30,390	13 784	359	109.6	179	54.7	18,350	8 324	595	181.5	298	90.7

Rope layer	Boomhoist Drum - 7/8" (22 mm) wire rope						Third Drum - 1" (25 mm) wire rope					
	Maximum line pull		No load line speed		Full load line speed		Maximum line pull		No load line speed		Full load line speed	
	lbs.	kg	ft./min	m/min	ft./min	m/min	lbs.	kg	ft./min	m/min	ft./min	m/min
1	40,842	18 526	147	44.9	134	40.8	20,656	9 369	442	135	105	32
2	36,760	16 674	163	49.8	149	45.3	18,752	8 506	486	148	116	35
3	33,417	15 158	180	54.8	163	49.8	17,169	7 788	531	162	127	39
4	30,633	13 895	196	59.8	178	54.4	15,833	7 182	576	176	138	42
5	28,276	12 826	213	64.8	193	58.9	14,690	6 663	621	189	148	45
6	26,257	11 910	229	69.7	208	63.4	--	--	--	--	--	--
7	24,506	11 116	245	74.7	223	67.9	--	--	--	--	--	--

Wire Rope Drum Capacities

Rope layer	Boomhoist Drum Capacity - 7/8" (22 mm) rope					
	Pitch Diameter		Layer		Total	
	in.	mm	ft.	m	ft.	m
1	15.88	403.2	51.8	15.8	51.8	15.8
2	17.63	447.7	57.1	17.4	108.9	33.2
3	19.38	492.1	62.3	19.0	171.2	52.2
4	21.13	536.6	67.2	20.5	238.5	72.7
5	22.88	581.0	72.5	22.1	311.0	94.8
6	24.63	625.5	77.4	23.6	388.4	118.4
7	26.38	669.9	82.7	25.2	471.1	143.6

Rope layer	Front Drum Capacity - 1" (25 mm) wire rope					
	Pitch Diameter		Layer		Total	
	in.	mm	ft.	m	ft.	m
1	20	508	113	34.3	113	34.3
2	22	559	123	37.4	235	71.7
3	24	610	133	40.4	368	112.1
4	26	660	142	43.4	510	155.5
5	28	711	153	46.5	663	202.0
6	30	762	163	49.6	825	251.6
7	32	813	173	52.6	998	304.2

Rope layer	Rear Drum Capacity - 1" (25 mm) wire rope					
	Pitch Diameter		Layer		Total	
	in.	mm	ft.	m	ft.	m
1	20	508	113	34.3	113	34.3
2	22	559	123	37.4	235	71.7
3	24	610	133	40.4	368	112.1
4	26	660	142	43.4	510	155.5
5	28	711	153	46.5	663	202.0
6	30	762	163	49.6	825	251.6
7	32	813	173	52.6	998	304.2

Rope layer	Third Drum Capacity - 1" (25 mm) wire rope					
	Pitch Diameter		Layer		Total	
	in.	mm	ft.	m	ft.	m
1	19.7	500	150	45.8	150	45.8
2	21.7	551	165	50.4	316	96.2
3	23.7	602	181	55.1	496	151.3
4	25.7	653	196	59.7	692	211.0
5	27.7	704	211	64.4	903	275.3
6	29.7	754	226	68.9	1,129	344.1

Wire Rope: size, type and working strength

Wire rope application	Size: diameter		Type	Max. permissible load	
	inches	mm		lbs.	kg
Boomhoist	7/8	22	LB	25,000	11 340
Main load hoist	1	25	N	29,500	13 400
Jib load hoist (1-part)	1	25	RB	22,760	10 320
Jib load hoist (2-parts)	1	25	RB	45,520	20 640
Boom pendants (dual)	1	25	N	69,000	31 300
Jib staylines	7/8	22	N	26,550	12 040

Wire Rope: types available

- Type "N" - 6 x 25 (6 x 19 class) filler wire, extra improved plow steel, preformed, independent wire rope center, right lay, regular lay.
- Type "LB" - 6 x 25 (6 x 19 class) filler wire, preformed, independent wire rope center, right lay, regular lay.
- Type "RB" - 19 x 19 non-rotating, extra, extra improved plow steel, preformed, right regular lay, swaged.

Hydraulic System

■ Hydraulic pumps

Two variable displacement piston pumps operating at 4,000 psi (281.24 kg/cm²) power travel, main drum, auxiliary drum, third drum, and boomhoist functions. Two fixed displacement gear pumps operating at 3,000 psi (211 kg/cm²) power swing, counterweight lowering, and machine jack functions. One fixed displacement gear pump operating at 1,210 psi (85 kg/cm²) powers pilot control system, clutches, brakes, and pump controls.

■ "Fine Inching" pump control mode

Special fine metering pump setting selectable from the operator's cab allows very slow movements for precision work. Main hoist, auxiliary hoist, boomhoist, third drum, and travel are all supplied with this standard feature.

■ Hydraulic reservoir

42 gal. (159 L), equipped with sight level gauge.

■ Relief valves

Each function is equipped with relief valves to protect the circuit from overload or shock.

■ Brake valves

Travel circuit is provided with brake valves for all terrain capability.

■ Hydraulic filtration

Ten micron, full flow line filter furnished in control circuit. All oil is filtered prior to return to sump tank.

■ Hydraulic motors

Main hoist drum, auxiliary hoist drum, boomhoist, swing, and travel are powered by axial piston motors.

■ Counterbalance valves

Upper - Hoist motors are equipped with counterbalance valves to provide positive load lowering and prevent accidental load drop when hydraulic power is suddenly reduced.

Lower - Travel motors equipped with counterbalance valve to prevent over-speeding of motors when traveling down an incline.

Principal Operating Functions

■ Control system

Remote controlled hydraulic servo for main drum and auxiliary drum. Mechanical linkage controls swing. Function speed is proportional to lever movement. Levers are adjustable for operator comfort.

■ Load hoisting and lowering

Main and auxiliary hoist drums are driven by individual axial piston motors and reduction gearing. Load hoisting or lowering is provided by actuating or reversing a hydraulic motor. The control lever provides two speeds for hoisting and lowering. Hoisting or lowering speeds are proportional to lever movement.

Freefall - The incorporation of power hydraulic controlled, two-shoe clutches allow freefall operation of the main and auxiliary hoist drums for high cycle crane and duty cycle application. Mode selection switch on control panel allows operator to select the most productive operation mode.

■ Load hoist drums

Main (front) and auxiliary (rear) hoist drums are 19" (.48 m) root diameter grooved for 1" (25 mm) wire rope. Mounted on anti-friction bearings.

Third operating drum - *Optional*; 12-1/2" (.32 m) grooved drum lagging, mounted in boom base section.

■ Drum clutches

Speed-o-Matic® power hydraulic two-shoe clutches; internal expanding, lined shoes. Clutch spiders are splined to shafts; clutch drums are integral with hoist drums.

Load hoist clutches - Front and rear main drums - clutch drums 30" (.76 m) diameter, 6-1/2" (.17 m) width.

■ Drum brakes

External contracting band type; operated by foot pedal equipped with a locking latch. Operator may select automatic brake mode* (spring applied, hydraulically released), which will apply brakes when the hoist control lever is in the neutral position.

*When in the automatic brake mode, the LS-248H II meets all OSHA requirements for personnel handling.

■ Drum rotation indicators

Standard for front and rear drums. Audible-type indicators.

■ Drum locking pawl

Standard for front and rear drums; electrically actuated and prevents drum rotation in a lowering direction.

■ Anti two-block system

Standard - A switch mounted on the boom peak activates a buzzer to warn the operator of a two-block condition and simultaneously disengages hoist function while applying the hoist brakes.

■ Swing system

Independent, hydraulic swing is driven by two axial piston motors through a gear reduction system; free swing when lever is in neutral position.

Swing brake - Spring applied, hydraulically released; controlled by button on swing control lever.

Swing lock - Mechanically controlled, two-position locking mechanism.

Optional - 360° locking mechanism available to meet New York City code.

Swing speed - Variable from 0 to 2 rpm.

■ Boomhoist/lowering system

Independent, hydraulic boomhoist is driven by an axial piston motor through a gear reduction system. Boom hoisting or lowering is performed by actuating or reversing the motor. Boomhoist speed is infinitely variable. Boomhoist speed from 0° to 70° boom angle is 90 seconds.

■ Boomhoist drum

Single grooved lagging 15" (.38 m) root diameter.

■ Boomhoist drum locking pawl

Electrically operated.

■ Boomhoist brake

Spring applied, hydraulically released, multiple disc type brake. Brake is automatically applied when control lever is in neutral position.

Boomhoist limiting device - Restricts hoisting boom beyond recommended minimum radius.

■ Electrical system

24 volt negative ground system with two 12-volt batteries. Standard lighting system includes: two 70 watt headlights mounted on machine front and one interior cab light.

■ Operator's cab

Full vision, modular compartment with safety glass panels. The completely independent cab is insulated against noise and vibration. Sliding operator's door, swing up roof window. Standard equipment includes: heater, air conditioner, defroster, windshield wiper, dry chemical fire extinguisher, sun visor, bubble-type level, fuel gauge, tachometer, hydraulic temperature gauge, engine oil pressure gauge, coolant temperature gauge, and service monitor system.

■ Machinery cab

Hinged doors (one on right side, two on left side) for machinery access. Equipped with rooftop access ladder, electric warning horn and skid resistant finish on roof.

■ Catwalks

Standard on right and left sides. Catwalks remove for reduced travel width.

■ Bail

Pinned to revolving frame. Seven sheaves are provided for 16 part boomhoist wire rope reeving. Sheaves mounted on "lifetime sealed" anti-friction bearings.

■ Counterweights

"A" upper ctwt. - 22,730 lb. (10 310 kg)

"AB" upper ctwt. - 67,470 lb. (30 604 kg)

"ABC" upper ctwt. - 96,430 lb. (43 741 kg)

Side frame ctwts. - see side frame auxiliary ctwt. description under Crawler Mounting on page 3.

Boom and Jib

■ Tubular boom

Two-piece basic boom 50' (15.24 m) long with open throat top section. Boom 80" (2.03 m) wide, 68" (1.73 m) deep at connections. Alloy steel round tubular cords 4" (.10 m) outside diameter. Maximum boom length is 280' (85.34 m).

■ Base section

20' (6.10 m) long; boomfeet on 55" (1.40 m) centers.

■ Boom extensions

Available in 10', 20', 30' and 40' (3.05, 6.10, 9.14 and 12.19 m) lengths with appropriate length pendants.

■ Boom connections

In-line pin connections.

■ Boom top section

Open throat; 30' (9.14 m) long.

■ Boompoint machinery

Six 21" (.53 m) root diameter sheaves mounted on "lifetime sealed" anti-friction bearings.

■ Hydraulic boomfoot pin removal

Standard; Speed-o-Matic controlled; located between mounting lugs on boom base section.

■ Boom live mast

30' (9.14 m) long; supports boomhoist bridle and boom pendants. Required for all boom lengths. May be used as short boom for assembling and disassembly of side frames and boom, but is not intended for general crane service. Refer to operator's manual for boom live mast lifting capacities.

■ Jib

Tubular; two-piece basic jib 30' (9.14 m) long; 32" (.81 m) wide, 24" (.61 m) deep at centerline of connections. Alloy steel tubular chords 2-1/4" (57 mm) outside diameter.

Base section - 13' 3" (4.04 m) long.

Jib extensions - Available in 10' (3.05 m) and 20' (6.10 m) lengths with appropriate length pendants.

Jib connections - In-line, tapered pins.

Tip section - 15' (4.57 m) long; equipped with single peak sheave 21" (.53 m) root diameter, heat treated and mounted on anti-friction bearings. Anchor provided at peak of jib tip section for two-part load hoist wire rope (whipline) connection.

Maximum jib length permitted - 100' (30.48 m). All jib lengths may be mounted at 5°, 15°, or 25° offset to boom.

■ Jib mast

17' 10" (5.44 m) long, mounted on jib base section. Two deflector sheaves mounted within mast to guide whipline; mounted on anti-friction bearings. Two equalizer sheaves mounted on top of mast - one for jib frontstay line, one for jib backstay line.

Jib staylines - Front and back staylines. Back staylines vary in length depending on degree of jib offset from boom centerline; back staylines attached at bottom end of boom top section.

Jib stops - Telescoping type; pinned from jib mast to boom top section and from jib mast to jib base section.

Auxiliary Equipment

■ Boom angle indicator

Pendulum type; mounted on boom base section. Electronic type readout on load indicator.

■ Hook blocks

Blocks, or weighted ball with swivel hook, *optional* - refer to price list.

■ Rated capacity limiter

Standard; PAT DS-350 rated capacity limiter, programmed with multiple charts, provides the operator with: main boom length, main boom angle, jib angle, jib length, operating mode, load radius, boom tip height, anti-two block indicator, pre-warning light, audible alarm, overload light, and load on hook.

■ Swing alarm

Standard; audio/visual warning device signals when upper is swinging.

■ Lifting slings

For handling side frames and auxiliary side frame counterweights.

This page intentionally blank

LS-248H II Lift Crane Capacities

PCSA Class 12-1080
Refer to notes page 11

Boom - Tube; 80" (2.03 m) wide, 68" (1.73m) deep with open throat top section. Hammerhead top section required for max. pick.

Jib - Tube; 32" (.81 m) wide, 24" (.61m) deep.

Counterweights - Refer to chart below.

Mounting - crawler:
overall length: 28' 6" (8.69 m)
gauge: 18' 10" (5.74 m)

Counterweights							
"A" Upper		"AB" Upper		"ABC" Upper		"A" Auxillary Lower	
Pounds	Kilograms	Pounds	Kilograms	Pounds	Kilograms	Pounds	Kilograms
22,730	10 310	67,470	30 604	96,430	43 741	48,000	21 773

Open throat boom or boom + jib machine can **lift off** ground unassisted, without load.

Counterweight		Over End Only			
		Boom		Boom + Jib	
		Feet	meters	Feet	meters
No Cwt.	Maximum	150	45.72	n/a	n/a
Cwt. "A"	Maximum	180	54.86	n/a	n/a
Cwt. "AB"	Maximum	240	73.15	n/a	n/a
Cwt. "ABC"	Maximum	270	82.30	n/a	n/a
Cwt. "ABC" + "A"	Maximum	280	85.34	240 + 100	73.15 + 30.48

Notes:

1. Booms must be erected or lowered over the end with no load.
2. Crane on firm and level surface.
3. Booms \geq 250 ft. (76.20 m) and longer require midpoint suspension pendants.

Working Areas

Note: These lines determine the limiting position of any load for operation within working areas indicated.

Caution: This material is for reference only. Operator must refer to the Crane Rating Manual to determine allowable machine lifting capacities and operating procedures.

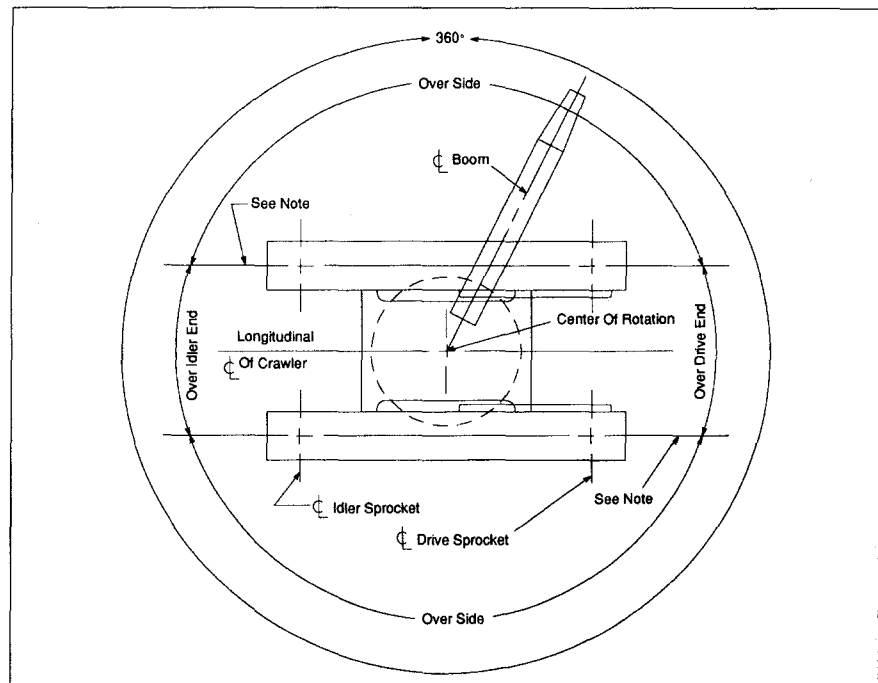

LS-248H II Lift Crane Capacities

35 FT. (10.67 m) TUBE BOOM - HAMMERHEAD TOP SECTION								
Load Radius (ft)	Boom Angle (deg)	360° Rotation					Over End Blocked	Load Radius (ft)
		ABC+A CTWT (lb)	ABC CTWT (lb)	AB CTWT (lb)	A CTWT (lb)	0 CTWT (lb)		
10	82.0	400,000					400,000	10
11	80.8	375,000					375,000	11
12	79.0	350,000					350,000	12
13	77.2	345,000					345,000	13
14	75.4	336,100					336,100	14
15	73.5	315,000					315,000	15
16	71.6	296,300					296,300	16
17	69.7	279,700					279,700	17
18	67.8	264,800					264,800	18
19	65.8	251,300					251,300	19
20	63.8	239,100					239,100	20
25	53.1	192,000					192,000	25
30	40.1	140,100					140,100	30
35	19.9	72,700					72,700	35

50 FT. (15.24 m) TUBE BOOM - OPEN THROAT TOP SECTION								
Load Radius (ft)	Boom Angle (deg)	360° Rotation					Over End Blocked	Load Radius (ft)
		ABC+A CTWT (lb)	ABC CTWT (lb)	AB CTWT (lb)	A CTWT (lb)	0 CTWT (lb)		
12	80.0	350,000	350,000	350,000	319,600	300,300	350,000	12
13	78.8	350,000	350,000	336,700	297,000	279,000	350,000	13
14	77.6	337,100	337,100	314,500	277,300	254,100	337,100	14
15	76.4	316,200	316,200	295,000	260,000	204,700	316,200	15
16	75.3	297,700	297,700	277,700	239,800	171,100	297,700	16
17	74.1	281,200	281,200	262,300	206,000	146,800	281,200	17
18	72.9	266,400	266,400	248,400	180,400	128,300	266,400	18
19	71.7	253,000	253,000	235,900	160,300	113,900	253,000	19
20	70.5	240,900	240,900	224,600	144,100	102,200	240,900	20
25	64.3	194,100	191,500	154,500	95,100	66,900	194,100	25
30	57.7	154,800	142,900	114,900	70,200	49,000	154,800	30
35	50.6	127,300	113,400	91,000	55,100	38,100	127,300	35
40	42.7	105,300	93,700	75,000	45,000	30,800	108,000	40
50	20.9	70,200	68,800	54,700	32,200	21,500	70,200	50

60 FT. (18.29 m) TUBE BOOM - OPEN THROAT TOP SECTION								
Load Radius (ft)	Boom Angle (deg)	360° Rotation					Over End Blocked	Load Radius (ft)
		ABC+A CTWT (lb)	ABC CTWT (lb)	AB CTWT (lb)	A CTWT (lb)	0 CTWT (lb)		
12	81.6	308,300	308,300	308,300	308,300	299,800	308,300	12
13	80.7	302,300	302,300	302,300	296,500	278,700	302,300	13
14	79.7	296,500	296,500	296,500	277,000	256,300	296,400	14
15	78.7	289,500	289,500	289,500	259,800	206,500	289,600	15
16	77.8	284,200	284,200	277,400	241,300	172,600	284,200	16
17	76.8	279,200	279,200	262,100	207,300	148,100	279,200	17
18	75.8	266,200	266,200	248,300	181,600	129,500	266,200	18
19	74.8	252,900	252,900	235,800	161,400	114,900	252,900	19
20	73.8	240,800	240,800	224,500	145,100	103,200	240,800	20
25	68.8	188,100	188,100	155,200	95,800	67,600	188,100	25
30	63.6	150,500	143,400	115,500	70,800	49,600	150,500	30
35	58.1	124,800	113,900	91,500	55,700	38,700	124,900	35
40	52.3	105,800	94,200	75,500	45,500	31,300	106,300	40
50	38.9	78,000	69,300	55,200	32,700	22,100	79,900	50
60	19.0	58,400	54,200	42,900	24,900	16,400	58,400	60

70 FT. (21.34 m) TUBE BOOM - OPEN THROAT TOP SECTION								
Load Radius (ft)	Boom Angle (deg)	360° Rotation					Over End Blocked	Load Radius (ft)
		ABC+A CTWT (lb)	ABC CTWT (lb)	AB CTWT (lb)	A CTWT (lb)	0 CTWT (lb)		
13	82.0	286,600	286,000	286,600	286,600	278,700	286,600	13
14	81.2	281,800	281,800	281,800	277,400	261,200	281,800	14
15	80.4	277,000	277,000	277,000	260,200	210,500	277,000	15
16	79.5	272,500	272,500	272,500	244,700	176,000	272,500	16
17	78.7	268,100	268,100	262,500	210,200	151,000	268,100	17
18	77.9	262,400	262,400	248,700	184,100	132,100	262,400	18
19	77.0	253,300	253,300	236,300	163,700	117,200	253,300	19
20	76.2	241,300	241,300	225,000	147,200	105,300	241,300	20
25	71.9	194,600	193,700	156,600	97,200	69,100	194,600	25
30	67.6	161,900	144,600	116,700	71,900	50,700	162,700	30
35	63.1	128,800	114,900	92,500	56,600	39,600	137,100	35
40	58.4	106,600	95,000	76,300	46,300	32,100	117,600	40
50	48.1	78,700	70,000	55,900	33,400	22,700	89,200	50
60	35.9	61,800	54,800	43,600	25,500	17,000	71,300	60
70	17.6	50,400	44,600	35,200	20,200	13,000	57,800	70

80 FT. (24.38 m) TUBE BOOM - OPEN THROAT TOP SECTION								
Load Radius (ft)	Boom Angle (deg)	360° Rotation					Over End Blocked	Load Radius (ft)
		ABC+A CTWT (lb)	ABC CTWT (lb)	AB CTWT (lb)	A CTWT (lb)	0 CTWT (lb)		
14.4	82.0	260,100	260,100	260,100	260,100	238,700	260,100	14.4
15	81.6	257,700	257,700	257,700	257,700	211,400	257,700	15
16	80.9	253,500	253,500	253,500	244,500	176,800	253,500	16
17	80.1	249,600	249,600	249,600	210,900	151,700	249,600	17
18	79.4	245,700	245,700	245,700	184,700	132,700	245,600	18
19	78.7	241,900	241,900	235,800	164,200	117,800	241,900	19
20	77.9	238,300	238,300	224,600	147,700	105,800	238,300	20
25	74.2	194,300	194,000	156,900	97,500	69,300	194,300	25
30	70.5	162,100	144,800	116,800	72,100	50,900	162,400	30
35	66.6	128,900	115,000	92,600	56,700	39,700	135,700	35
40	62.7	106,700	95,100	76,400	46,500	32,300	116,500	40
50	54.3	78,800	70,100	56,000	33,500	22,800	88,600	50
60	44.8	61,900	54,900	43,700	25,700	17,100	71,400	60
70	33.5	50,600	44,800	35,400	20,400	13,200	59,000	70
80	16.5	42,400	37,400	29,400	16,500	10,400	48,400	80

90 FT. (27.43 m) TUBE BOOM - OPEN THROAT TOP SECTION								
Load Radius (ft)	Boom Angle (deg)	360° Rotation					Over End Blocked	Load Radius (ft)
		ABC+A CTWT (lb)	ABC CTWT (lb)	AB CTWT (lb)	A CTWT (lb)	0 CTWT (lb)		
15.8	82.0	239,200	239,200	239,200	239,200	183,300	239,200	15.8
16	81.9	238,500	238,500	238,500	238,500	177,400	238,500	16
17	81.2	233,500	233,500	233,500	211,400	152,200	233,500	17
18	80.6	230,000	230,000	230,000	185,200	133,100	230,000	18
19	79.9	226,600	226,600	226,600	164,600	118,100	226,600	19
20	79.3	223,400	223,400	223,400	148,000	106,100	223,300	20
25	76.0	193,900	193,900	157,100	97,700	69,500	193,900	25
30	72.7	160,800	144,900	116,900	72,200	51,000	160,900	30
35	69.4	129,000	115,100	92,700	56,800	39,800	134,300	35
40	65.9	106,700	95,100	76,400	46,500	32,300	115,500	40
50	58.7	78,800	70,100	56,000	33,500	22,800	88,400	50
60	50.9	61,900	54,900	43,700	25,700	17,100	71,000	60
70	42.2	50,600	44,800	35,400	20,400	13,300	59,900	70
80	31.5	42,500	37,500	29,500	16,600	10,500	49,400	80
90	15.5	36,300	31,900	24,900	13,600	8,300	41,300	90

LS-248H II Lift Crane Capacities

100 FT. (30.48 m) TUBE BOOM - OPEN THROAT TOP SECTION								
Load Radius (ft)	Boom Angle (deg)	360° Rotation					Over End Blocked	Load Radius (ft)
		ABC+A CTWT (lb)	ABC CTWT (lb)	AB CTWT (lb)	A CTWT (lb)	0 CTWT (lb)		
17.2	82.0	219,200	219,200	219,200	206,100	148,500	219,200	17.2
18	81.5	216,700	216,700	216,700	185,500	133,500	216,700	18
19	81.0	213,800	213,800	213,800	164,900	118,500	213,800	19
20	80.4	210,800	210,800	210,800	148,200	106,400	210,800	20
25	77.5	193,500	193,500	157,200	97,800	69,600	193,500	25
30	74.5	159,400	144,900	117,000	72,300	51,000	159,400	30
35	71.5	129,000	115,100	92,700	56,800	39,800	133,200	35
40	68.5	106,700	95,100	76,400	46,500	32,300	114,500	40
50	62.1	78,700	70,000	56,000	33,500	22,800	88,400	50
60	55.4	61,900	54,900	43,600	25,600	17,100	70,500	60
70	48.1	50,600	44,800	35,400	20,300	13,200	58,900	70
80	39.9	42,500	37,500	29,400	16,500	10,400	49,500	80
90	29.9	36,400	32,000	24,900	13,700	8,300	42,000	90
100	14.7	31,500	27,600	21,400	11,300	6,600	35,600	100

110 FT. (33.53 m) TUBE BOOM - OPEN THROAT TOP SECTION								
Load Radius (ft)	Boom Angle (deg)	360° Rotation					Over End Blocked	Load Radius (ft)
		ABC+A CTWT (lb)	ABC CTWT (lb)	AB CTWT (lb)	A CTWT (lb)	0 CTWT (lb)		
18.6	82.0	201,100	201,100	201,100	173,100	124,500	201,100	18.6
19	81.8	200,000	200,000	200,000	165,100	118,700	200,000	19
20	81.3	197,500	197,500	197,500	148,500	106,600	197,500	20
25	78.6	185,300	185,300	157,300	97,900	69,700	185,400	25
30	75.9	158,100	144,900	117,000	72,300	51,000	158,200	30
35	73.2	128,900	115,000	92,700	56,800	39,800	132,100	35
40	70.5	106,600	95,000	76,300	46,400	32,200	113,500	40
50	64.9	78,600	69,900	55,900	33,400	22,700	87,700	50
60	59.0	61,800	54,800	43,500	25,500	17,000	69,900	60
70	52.7	50,500	44,700	35,300	20,200	13,100	58,700	70
80	45.8	42,400	37,400	29,300	16,400	10,300	49,300	80
90	38.0	36,300	31,900	24,900	13,600	8,200	42,000	90
100	28.4	31,500	27,600	21,300	11,300	6,500	36,200	100
110	14.0	27,600	24,100	18,500	9,400	5,100	31,000	110

120 FT. (36.58 m) TUBE BOOM - OPEN THROAT TOP SECTION								
Load Radius (ft)	Boom Angle (deg)	360° Rotation					Over End Blocked	Load Radius (ft)
		ABC+A CTWT (lb)	ABC CTWT (lb)	AB CTWT (lb)	A CTWT (lb)	0 CTWT (lb)		
20.0	82.0	186,200	186,200	186,200	148,900	106,900	186,200	20.0
25	79.6	173,900	173,900	157,300	97,900	69,800	173,900	25
30	77.1	156,900	144,900	117,000	72,200	51,000	156,900	30
35	74.7	128,900	115,000	92,600	56,700	39,700	131,100	35
40	72.2	106,500	94,900	76,300	46,300	32,100	112,600	40
50	67.1	78,500	69,800	55,800	33,200	22,600	86,900	50
60	61.8	61,600	54,600	43,400	25,400	16,800	69,300	60
70	56.2	50,300	44,500	35,100	20,100	13,000	58,300	70
80	50.3	42,200	37,200	29,200	16,300	10,200	49,000	80
90	43.7	36,100	31,800	24,700	13,400	8,100	41,800	90
100	36.3	31,400	27,500	21,200	11,200	6,400	36,100	100
110	27.2	27,500	24,000	18,400	9,400	5,100	31,400	110
120	13.4	24,300	21,100	16,000	7,800	3,900	27,500	120

130 FT. (39.62 m) TUBE BOOM - OPEN THROAT TOP SECTION								
Load Radius (ft)	Boom Angle (deg)	360° Rotation					Over End Blocked	Load Radius (ft)
		ABC+A CTWT (lb)	ABC CTWT (lb)	AB CTWT (lb)	A CTWT (lb)	0 CTWT (lb)		
21.4	82.0	171,200	171,200	171,200	130,500	93,500	171,200	21.4
25	80.4	164,400	164,400	157,300	97,900	69,800	164,400	25
30	78.1	155,800	144,800	116,900	72,200	51,000	155,700	30
35	75.9	128,800	114,900	92,500	56,600	39,600	130,200	35
40	73.6	106,400	94,800	76,100	46,200	32,000	111,800	40
50	68.9	78,400	69,700	55,600	33,100	22,400	86,300	50
60	64.1	61,500	54,500	43,200	25,200	16,700	68,700	60
70	59.1	50,200	44,300	35,000	19,900	12,800	57,800	70
80	53.8	42,100	37,100	29,000	16,100	10,000	48,600	80
90	48.2	36,000	31,600	24,600	13,300	7,900	41,500	90
100	41.9	31,200	27,300	21,100	11,000	6,300	35,900	100
110	34.8	27,400	23,900	18,300	9,200	4,900	31,300	110
120	26.1	24,200	21,100	15,900	7,700	3,800	28,000	120
130	12.9	21,600	18,600	13,900	6,400	2,800	24,100	130

140 FT. (42.67 m) TUBE BOOM - OPEN THROAT TOP SECTION								
Load Radius (ft)	Boom Angle (deg)	360° Rotation					Over End Blocked	Load Radius (ft)
		ABC+A CTWT (lb)	ABC CTWT (lb)	AB CTWT (lb)	A CTWT (lb)	0 CTWT (lb)		
22.8	82.0	158,800	158,800	158,800	115,900	82,900	158,800	22.8
25	81.1	155,200	155,200	155,200	97,900	69,800	155,200	25
30	79.0	146,000	144,800	116,900	72,100	50,900	146,000	30
35	76.9	128,700	114,800	92,400	56,500	39,500	129,300	35
40	74.8	106,300	94,700	76,000	46,100	31,900	111,000	40
50	70.5	78,200	69,500	55,500	33,000	22,300	85,600	50
60	66.1	61,300	54,300	43,100	25,000	16,500	68,200	60
70	61.5	50,000	44,200	34,800	19,700	12,600	57,200	70
80	56.8	41,900	36,900	28,800	16,000	9,800	48,100	80
90	51.7	35,800	31,400	24,400	13,100	7,700	41,100	90
100	46.3	31,000	27,200	20,900	10,900	6,100	35,600	100
110	40.3	27,200	23,700	18,100	9,100	4,800	31,100	110
120	33.5	24,100	20,900	15,800	7,600	3,700	28,000	120
130	25.2	21,400	18,500	13,800	6,300	2,700	24,500	130
140	12.4	19,200	16,500	12,100	5,200	2,200	21,200	140

150 FT. (45.72 m) TUBE BOOM - OPEN THROAT TOP SECTION								
Load Radius (ft)	Boom Angle (deg)	360° Rotation					Over End Blocked	Load Radius (ft)
		ABC+A CTWT (lb)	ABC CTWT (lb)	AB CTWT (lb)	A CTWT (lb)	0 CTWT (lb)		
24.2	82.0	146,000	146,000	146,000	104,000		146,000	24.2
25	81.7	144,800	144,800	144,800	97,900		144,800	25
30	79.7	138,100	138,100	116,800	72,000		138,100	30
35	77.8	128,500	114,700	92,300	56,400		128,500	35
40	75.8	106,200	94,600	75,900	45,900		110,200	40
50	71.9	78,100	69,300	55,300	32,800		84,900	50
60	67.8	61,100	54,100	42,900	24,900		67,600	60
70	63.6	49,800	44,000	34,600	19,600		56,800	70
80	59.2	41,700	36,700	28,600	15,800		47,700	80
90	54.7	35,600	31,200	24,200	12,900		40,700	90
100	49.8	30,800	27,000	20,700	10,700		35,200	100
110	44.6	27,000	23,500	17,900	8,900		30,800	110
120	38.9	23,900	20,700	15,600	7,400		27,800	120
130	32.3	21,300	18,400	13,700	6,100		24,500	130
140	24.3	19,000	16,300	12,000	5,000		21,500	140
150	12.0	17,100	14,600	10,500	4,100		18,700	150

LS-248H II Lift Crane Capacities

160 FT. (48.77 m) TUBE BOOM - OPEN THROAT TOP SECTION

Load Radius (ft)	Boom Angle (deg)	360° Rotation					Over End Blocked	Load Radius (ft)
		ABC+A CTWT (lb)	ABC CTWT (lb)	AB CTWT (lb)	A CTWT (lb)	0 CTWT (lb)		
25.6	82.0	135,700	135,700	135,700	94,200		135,700	25.6
30	80.4	130,400	130,400	116,700	71,900		130,400	30
35	78.6	124,600	114,500	92,200	56,300		124,600	35
40	76.7	106,000	94,400	75,700	45,800		109,600	40
50	73.0	77,900	69,200	55,100	32,600		84,300	50
60	69.2	60,900	53,900	42,700	24,700		67,000	60
70	65.4	49,600	43,800	34,400	19,300		56,200	70
80	61.3	41,500	36,500	28,400	15,500		47,200	80
90	57.2	35,400	31,000	24,000	12,700		40,300	90
100	52.8	30,600	26,700	20,500	10,400		34,600	100
110	48.2	26,800	23,300	17,700	8,600		30,400	110
120	43.2	23,700	20,500	15,400	7,200		27,600	120
130	37.6	21,100	18,100	13,400	5,900		24,300	130
140	31.3	18,800	16,100	11,800	4,800		21,400	140
150	23.5	16,900	14,400	10,400	3,900		18,900	150
160	11.6	15,200	12,900	9,100	3,100		16,500	160

170 FT. (51.82 m) TUBE BOOM - OPEN THROAT TOP SECTION

Load Radius (ft)	Boom Angle (deg)	360° Rotation					Over End Blocked	Load Radius (ft)
		ABC+A CTWT (lb)	ABC CTWT (lb)	AB CTWT (lb)	A CTWT (lb)	0 CTWT (lb)		
27.0	82.0	126,100	126,100	126,100	86,000		126,100	27.0
30	81.0	122,900	122,900	116,600	71,800		122,900	30
35	79.2	116,100	114,400	92,000	56,100		116,100	35
40	77.5	105,900	94,300	75,600	45,600		108,900	40
50	74.0	77,700	69,000	54,900	32,400		83,700	50
60	70.5	60,700	53,700	42,500	24,500		66,400	60
70	66.9	49,400	43,600	34,200	19,100		55,700	70
80	63.2	41,300	36,300	28,200	15,300		46,700	80
90	59.3	35,200	30,800	23,700	12,500		39,800	90
100	55.3	30,400	26,500	20,200	10,200		34,400	100
110	51.1	26,600	23,100	17,400	8,400		30,100	110
120	46.6	23,500	20,300	15,200	6,900		27,200	120
130	41.8	20,800	17,900	13,200	5,700		24,000	130
140	36.5	18,600	15,900	11,600	4,600		21,200	140
150	30.3	16,700	14,200	10,200	3,700		18,800	150
160	22.8	15,000	12,700	8,900	2,900		16,600	160
170	11.3	13,500	11,300	7,800	2,200		14,400	170

180 FT. (54.86 m) TUBE BOOM - OPEN THROAT TOP SECTION

Load Radius (ft)	Boom Angle (deg)	360° Rotation					Over End Blocked	Load Radius (ft)
		ABC+A CTWT (lb)	ABC CTWT (lb)	AB CTWT (lb)	A CTWT (lb)	0 CTWT (lb)		
28.3	82.0	115,900	115,900	115,900	78,900		115,900	28.3
30	81.5	114,200	114,200	114,200	71,700		114,200	30
35	79.9	109,500	109,500	91,900	56,000		109,500	35
40	78.2	104,900	94,100	75,400	45,500		104,900	40
50	75.0	77,500	68,800	54,700	32,200		83,100	50
60	71.6	60,500	53,500	42,300	24,300		65,900	60
70	68.2	49,200	43,300	34,000	18,900		55,200	70
80	64.8	41,000	36,000	28,000	15,100		46,200	80
90	61.2	34,900	30,600	23,500	12,200		39,400	90
100	57.5	30,200	26,300	20,000	10,000		34,000	100
110	53.6	26,400	22,900	17,200	8,200		29,600	110
120	49.6	23,200	20,000	14,900	6,700		26,900	120
130	45.3	20,600	17,700	13,000	5,500		23,600	130
140	40.6	18,400	15,700	11,400	4,400		20,900	140
150	35.4	16,500	14,000	10,000	3,500		18,500	150
160	29.5	14,800	12,500	8,700	2,700		16,400	160
170	22.1	13,300	11,200	7,600	2,000		14,500	170
180	11.0	12,000	9,900	6,600	1,600		12,600	180

190 FT. (57.91 m) TUBE BOOM - OPEN THROAT TOP SECTION								
Load Radius (ft)	Boom Angle (deg)	360° Rotation					Over End Blocked	Load Radius (ft)
		ABC+A CTWT (lb)	ABC CTWT (lb)	AB CTWT (lb)	A CTWT (lb)	0 CTWT (lb)		
29.7	82.0	107,100	107,100	107,100			107,100	29.7
30	81.9	107,100	107,100	107,100			107,100	30
35	80.4	103,100	103,100	91,700			103,100	35
40	78.9	98,900	93,900	75,200			98,900	40
50	75.8	77,300	68,600	54,500			82,600	50
60	72.6	60,300	53,300	42,100			65,400	60
70	69.4	48,900	43,100	33,700			54,700	70
80	66.2	40,800	35,800	27,800			45,700	80
90	62.8	34,700	30,300	23,300			38,900	90
100	59.4	29,900	26,000	19,800			33,500	100
110	55.8	26,100	22,600	17,000			29,500	110
120	52.1	23,000	19,800	14,700			26,500	120
130	48.2	20,400	17,500	12,800			23,300	130
140	44.0	18,200	15,500	11,100			20,800	140
150	39.4	16,200	13,700	9,700			18,200	150
160	34.4	14,600	12,300	8,500			16,100	160
170	28.7	13,100	10,900	7,400			14,300	170
180	21.5	11,800	9,800	6,400			12,600	180
190	10.7	10,600	8,700	5,500			10,900	190

200 FT. (60.96 m) TUBE BOOM - OPEN THROAT TOP SECTION								
Load Radius (ft)	Boom Angle (deg)	360° Rotation					Over End Blocked	Load Radius (ft)
		ABC+A CTWT (lb)	ABC CTWT (lb)	AB CTWT (lb)	A CTWT (lb)	0 CTWT (lb)		
31.1	82.0	95,300	95,300	95,300			95,300	31.1
35	80.9	94,100	94,100	91,600			94,100	35
40	79.4	93,100	93,100	75,100			93,100	40
50	76.5	77,100	68,400	54,300			82,000	50
60	73.5	60,100	53,100	41,800			64,800	60
70	70.5	48,700	42,900	33,500			54,200	70
80	67.4	40,600	35,600	27,500			45,200	80
90	64.3	34,400	30,100	23,000			38,400	90
100	61.1	29,700	25,800	19,500			33,100	100
110	57.8	25,900	22,400	16,700			29,400	110
120	54.3	22,700	19,600	14,400			26,100	120
130	50.7	20,100	17,200	12,500			22,900	130
140	46.9	17,900	15,200	10,900			20,200	140
150	42.8	16,000	13,500	9,500			17,900	150
160	38.4	14,300	12,000	8,200			15,800	160
170	33.5	12,900	10,700	7,200			14,000	170
180	27.9	11,600	9,500	6,200			12,400	180
190	21.0	10,400	8,500	5,300			10,900	190
200	10.4	9,400	7,500	4,500			9,400	200

210 FT. (64.01 m) TUBE BOOM - OPEN THROAT TOP SECTION								
Load Radius (ft)	Boom Angle (deg)	360° Rotation					Over End Blocked	Load Radius (ft)
		ABC+A CTWT (lb)	ABC CTWT (lb)	AB CTWT (lb)	A CTWT (lb)	0 CTWT (lb)		
32.5	82.0	83,900	83,900	83,900			83,900	32.5
35	81.3	83,900	83,900	83,900			83,900	35
40	79.9	82,800	82,800	74,900			82,600	40
50	77.1	76,900	68,200	54,100			79,600	50
60	74.3	59,900	52,900	41,600			64,300	60
70	71.5	48,500	42,600	33,300			53,700	70
80	68.6	40,300	35,300	27,300			44,800	80
90	65.6	34,200	29,800	22,800			38,000	90
100	62.6	29,400	25,500	19,300			32,700	100
110	59.5	25,600	22,100	16,500			29,400	110
120	56.2	22,500	19,300	14,200			26,700	120
130	52.9	19,900	16,900	12,200			22,500	130
140	49.4	17,700	15,000	10,600			19,800	140
150	45.7	15,700	13,200	9,200			17,500	150
160	41.7	14,100	11,800	8,000			15,500	160
170	37.4	12,600	10,400	6,900			13,700	170
180	32.7	11,400	9,300	6,000			12,100	180
190	27.2	10,200	8,300	5,100			10,700	190
200	20.5	9,200	7,300	4,300			9,300	200
210	10.1	8,000	6,400	3,800			8,000	210

LS-248H II Lift Crane Capacities

220 FT. (67.06 m) TUBE BOOM - OPEN THROAT TOP SECTION								
Load Radius (ft)	Boom Angle (deg)	360° Rotation					Over End Blocked	Load Radius (ft)
		ABC+A CTWT (lb)	ABC CTWT (lb)	AB CTWT (lb)	A CTWT (lb)	0 CTWT (lb)		
33.9	82.0	75,200	75,200	75,200			75,200	33.9
35	81.7	75,200	75,200	75,200			75,000	35
40	80.4	74,300	74,300	74,300			74,300	40
50	77.7	72,400					73,100	50
60	75.1	59,600	68,000	53,900			63,800	60
70	72.3	48,200	52,700	41,400			53,200	70
80	69.6	40,100	48,200	42,400			44,300	80
90	66.8	34,000	35,100	27,000			37,500	90
100	63.9	29,200	29,600	22,500			32,200	100
110	61.0	25,400	25,300	19,000			29,000	110
120	58.0	22,200	21,900	16,200			25,200	120
130	54.8	19,600	19,000	13,900			22,100	130
140	51.6	17,400	16,700	12,000			19,400	140
150	48.2	15,500	14,700	10,400			17,100	150
160	44.6	13,800	13,000	9,000			15,100	160
170	40.7	12,400	11,500	7,700			13,300	170
180	36.6	11,100	10,200	6,700			11,800	180
190	31.9	10,000	9,000	5,700			10,400	190
200	26.6	8,900	8,000	4,900			9,100	200
210	20.0	7,900	7,100	4,100			7,900	210
220	9.9	6,600	6,200	3,400			6,600	220
			5,400	2,700				

230 FT. (70.10 m) TUBE BOOM - OPEN THROAT TOP SECTION								
Load Radius (ft)	Boom Angle (deg)	360° Rotation					Over End Blocked	Load Radius (ft)
		ABC+A CTWT (lb)	ABC CTWT (lb)	AB CTWT (lb)	A CTWT (lb)	0 CTWT (lb)		
35.3	82.0	68,100	68,100	68,100			68,100	35.3
40	80.8	67,200	67,200	67,100			67,200	40
50	78.3	65,600	65,600	53,700			65,600	50
60	75.7	59,400	52,400	41,200			61,900	60
70	73.1	48,000	42,200	32,800			52,700	70
80	70.5	39,800	34,800	26,800			43,600	80
90	67.8	33,700	29,300	22,300			37,100	90
100	65.1	28,900	25,000	18,800			31,700	100
110	62.4	25,100	21,600	16,000			28,600	110
120	59.5	22,000	18,800	13,700			24,800	120
130	56.6	19,300	16,400	11,700			21,600	130
140	53.5	17,100	14,400	10,100			19,000	140
150	50.4	15,200	12,700	8,700			16,700	150
160	47.0	13,600	11,200	7,500			14,700	160
170	43.5	12,100	9,900	6,400			13,000	170
180	39.8	10,800	8,800	5,500			11,400	180
190	35.7	9,700	7,700	4,600			10,000	190
200	31.2	8,700	6,800	3,800			8,800	200
210	26.0	7,600	6,000	3,200			7,600	210
220	19.6	6,500	5,200	2,500			6,500	220
230	9.7	5,400	4,500				5,400	230

240 FT. (73.15 m) TUBE BOOM - OPEN THROAT TOP SECTION								
Load Radius (ft)	Boom Angle (deg)	360° Rotation					Over End Blocked	Load Radius (ft)
		ABC+A CTWT (lb)	ABC CTWT (lb)	AB CTWT (lb)	A CTWT (lb)	0 CTWT (lb)		
36.7	82.0	61,200	61,200	61,200			61,200	36.7
40	81.2	60,400	60,400	60,400			60,400	40
50	78.8	57,800	57,800	53,500			57,700	50
60	76.3	54,900	52,200	40,900			54,800	60
70	73.9	47,800	41,900	32,500			49,600	70
80	71.4	39,600	34,600	26,500			43,400	80
90	68.8	33,400	29,100	22,000			36,600	90
100	66.2	28,700	24,800	18,500			31,300	100
110	63.6	24,800	21,300	15,700			27,700	110
120	60.9	21,700	18,500	13,400			24,400	120
130	58.1	19,100	16,200	11,500			21,200	130
140	55.3	16,900	14,200	9,800			18,600	140
150	52.3	15,000	12,500	8,400			16,300	150
160	49.2	13,300	11,000	7,200			14,300	160
170	46.0	11,900	9,700	6,100			12,600	170
180	42.6	10,600	8,500	5,200			11,000	180
190	38.9	9,400	7,500	4,300			9,700	190
200	34.9	8,400	6,600	3,600			8,400	200
210	30.5	7,300	5,700	2,900			7,300	210
220	25.4	6,200	5,000	2,300			6,200	220
230	19.1	5,200	4,200				5,200	230
240	9.5	4,200	3,600				4,200	240

250 FT. (76.20 m) TUBE BOOM - OPEN THROAT TOP SECTION								
Load Radius (ft)	Boom Angle (deg)	360° Rotation					Over End Blocked	Load Radius (ft)
		ABC+A CTWT (lb)	ABC CTWT (lb)	AB CTWT (lb)	A CTWT (lb)	0 CTWT (lb)		
38.1	82.0	53,900	53,900				53,900	38.1
40	81.6	53,900	53,900				53,900	40
50	79.2	52,500	52,500				52,300	50
60	76.9	49,600	49,600				49,700	60
70	74.5	45,200	41,700				45,300	70
80	72.1	39,300	34,300				41,100	80
90	69.7	33,100	28,800				36,300	90
100	67.2	28,300	24,500				31,100	100
110	64.7	24,500	21,000				26,500	110
120	62.2	21,400	18,200				23,600	120
130	59.5	18,700	15,800				21,100	130
140	56.8	16,500	13,800				18,600	140
150	54.1	14,600	12,100				15,900	150
160	51.2	12,900	10,600				13,700	160
170	48.2	11,500	9,300				11,700	170
180	45.0	9,900	8,100				9,900	180
190	41.7	8,400	7,100				8,400	190
200	38.1	8,000	6,200				8,000	200
210	34.2	7,100	5,300				7,500	210
220	29.9	6,200	4,600				6,500	220
230	24.9	5,300	3,900				5,300	230
240	18.8	3,300	3,200				3,300	240
250	9.3	2,800	2,600				2,800	250

260 FT. (79.25 m) TUBE BOOM - OPEN THROAT TOP SECTION								
Load Radius (ft)	Boom Angle (deg)	360° Rotation					Over End Blocked	Load Radius (ft)
		ABC+A CTWT (lb)	ABC CTWT (lb)	AB CTWT (lb)	A CTWT (lb)	0 CTWT (lb)	ABC+A CTWT (lb)	
39.5	82.0	48,900	48,900				48,900	39.5
40	81.9	48,900	48,900				48,900	40
50	79.6	47,700	47,700				47,700	50
60	77.4	45,000	45,000				45,000	60
70	75.1	41,100	41,100				41,100	70
80	72.8	37,500	34,000				37,500	80
90	70.5	32,900	28,500				33,800	90
100	68.2	28,100	24,200				30,800	100
110	65.8	24,200	20,700				25,000	110
120	63.3	21,100	17,900				23,300	120
130	60.8	18,500	15,500				21,600	130
140	58.3	16,200	13,500				19,900	140
150	55.6	14,300	11,800				17,700	150
160	52.9	12,700	10,300				15,800	160
170	50.1	11,200	9,000				14,100	170
180	47.2	9,900	7,900				12,600	180
190	44.1	8,800	6,800				11,200	190
200	40.8	7,800	5,900				10,000	200
210	37.3	6,800	5,100				8,900	210
220	33.5	6,000	4,300				7,800	220
230	29.3	5,200	3,600				6,800	230
240	24.4	4,500	3,000				5,800	240
250	18.4	3,800	2,400				4,800	250
260	9.1	3,200					3,500	260

270 FT. (82.30 m) TUBE BOOM - OPEN THROAT TOP SECTION								
Load Radius (ft)	Boom Angle (deg)	360° Rotation					Over End Blocked	Load Radius (ft)
		ABC+A CTWT (lb)	ABC CTWT (lb)	AB CTWT (lb)	A CTWT (lb)	0 CTWT (lb)	ABC+A CTWT (lb)	
40.9	82.0	44,400	44,400				44,400	40.9
50	80.0	43,300	43,300				43,500	50
60	77.9	40,900	40,900				40,800	60
70	75.7	37,300	37,300				37,200	70
80	73.5	33,800	33,800				33,900	80
90	71.3	30,800	28,300				31,000	90
100	69.0	27,000	23,900				26,700	100
110	66.7	24,000	20,500				24,700	110
120	64.4	20,800	17,600				22,500	120
130	62.0	18,200	15,300				20,800	130
140	59.6	16,000	13,300				19,000	140
150	57.1	14,100	11,600				17,300	150
160	54.5	12,400	10,100				16,000	160
170	51.9	10,900	8,800				14,400	170
180	49.1	9,700	7,600				12,900	180
190	46.2	8,500	6,600				11,600	190
200	43.2	7,500	5,600				10,400	200
210	40.0	6,600	4,800				9,300	210
220	36.6	5,700	4,000				8,300	220
230	32.9	4,900	3,400				7,400	230
240	28.7	4,200	2,700				6,600	240
250	24.0	3,600	2,100				5,800	250
260	18.0	3,000					5,000	260
270	8.9	2,400					2,400	270

280 FT. (85.34 m) TUBE BOOM - OPEN THROAT TOP SECTION								
Load Radius (ft)	Boom Angle (deg)	360° Rotation					Over End Blocked	Load Radius (ft)
		ABC+A CTWT (lb)	ABC CTWT (lb)	AB CTWT (lb)	A CTWT (lb)	0 CTWT (lb)		
42.3	82.0	40,400					40,400	42.3
50	80.4	39,600					39,600	50
60	78.3	37,200					37,200	60
70	76.2	33,900					34,000	70
80	74.1	30,900					30,800	80
90	72.0	26,700					26,700	90
100	69.8	24,300					24,400	100
110	67.6	22,400					22,300	110
120	65.4	20,400					20,400	120
130	63.1	17,900					18,600	130
140	60.8	15,700					17,200	140
150	58.4	13,800					15,700	150
160	56.0	12,100					14,500	160
170	53.5	10,700					13,500	170
180	50.9	9,400					12,400	180
190	48.2	8,200					11,300	190
200	45.4	7,200					10,100	200
210	42.4	6,300					9,000	210
220	39.3	5,400					8,000	220
230	35.9	4,700					7,100	230
240	32.3	4,000					6,300	240
250	28.2	3,300					5,600	250
260	23.5	2,700					4,900	260
270	17.7	2,200					3,900	270
280	8.8							280

Notes: Lift Crane Capacities

General:

- Rated lifting capacities in pounds as shown on lift charts pertain to the crane as originally manufactured and normally equipped. Modifications to the crane or use of optional equipment other than that specified can result in a reduction of capacity.
- Construction equipment can be dangerous if improperly operated or maintained. Operation and maintenance of the crane must be in compliance with the information in the Operator's, Parts and Safety Manuals supplied with the crane. If these manuals are missing, order replacements through the distributor.
- The operator and other personnel associated with the crane shall read and fully understand the latest applicable American National Standards Institute (ANSI) safety standards for cranes.
- The maximum allowable lifting capacities are based on crane standing level on firm supporting surface.
- All capacities listed are in compliance with ASME/ANSI B30.5b-1991, SAE J987-April 1991, and SAE J765-October 1990.

Set-Up:

- The crane shall be leveled on a firm supporting surface. Depending on the nature of the supporting surface, it may be necessary to have structural supports under the crawler side frames to spread the load to a larger bearing surface.
- For required parts of line, see wire rope strength and winch performance tables in Crane Rating Manual.

Lift Crane Operation:

- Capacities shown are in pounds and are not more than 75% of the tipping loads with the crane standing level on firm supporting surface. A deduction must be made from these capacities for weight of hook block, hook, sling, grapple, load weighing device, etc. When using main hook while jib is attached, reduce capacities by values shown in Crane Rating Manual. See Operator's Manual for all limitations when raising or lowering attachment.
- The capacities in the shaded areas are based on structural strength. The capacities in the non-shaded areas are based on stability ratings.
- For recommended reeving, parts of line, wire rope type and wire rope inspection, see wire rope strength chart, Operator's Manual and Parts Manual.
- Load ratings are based on freely suspended loads and make no allowances for such factors as the effect of the wind, ground conditions, and operating speeds. The operator shall therefore reduce load ratings in order to take these conditions into account.
- Rated lifting capacities do not account for the effects of wind on a suspended load or boom. Lifting capacities should be considered acceptable for wind speeds less than 20 mph (32.19 km/hr) and appropriately reduced for wind speeds greater than 20 mph (32.19 km/hr). Extreme caution should be used when lifting heavy loads or loads with large wind sail area under high wind conditions (over 20 mph - 32.19 km/hr).

- Auxiliary lower counterweights are to be used for specific, infrequent lifts only. Avoid travel with lower counterweights installed on machine. Doing so may cause decreased travel torque and/or excessive wear to drive components.
- The 30' (9.14 m) live mast must be used for all capacities listed.
- The least stable rated condition is over the side.
- Booms must be erected and lowered over the end.
- Do not operate at radii and boom lengths where the Crane Rating Manual lists no capacity. Do not use longer booms or jibs than those listed in the Crane Rating Manual. Any of the above can cause a tipping condition, or boom and jib failure.
- These capacities apply only to the crane as originally manufactured and normally equipped by Link-Belt Construction Equipment Company.

For Over End Capacities Only:

- These capacities can be lifted over either end with crane standing level on firm supporting surface with **adequate blocking placed under the tread member sprockets/ idlers** at the lift off end, to prevent rocking.
- Do not travel with a load.

Jib Capacities

Hydraulic Lattice Boom Truck Crane

HC-238H II HYLAB Series

150-ton (136 metric ton)

Tube Boom + Jib

- 50' – 230' (15.24 – 70.10 m)
Open Throat Boom
- 30' – 75' (9.14 – 22.86 m) Jib
- On Fully Extended Outriggers
- 360° Rotation
- "ABC" + "A" Counterweight
Options

Note: ABC + 0 capacities are published in the Crane Rating Manual only.

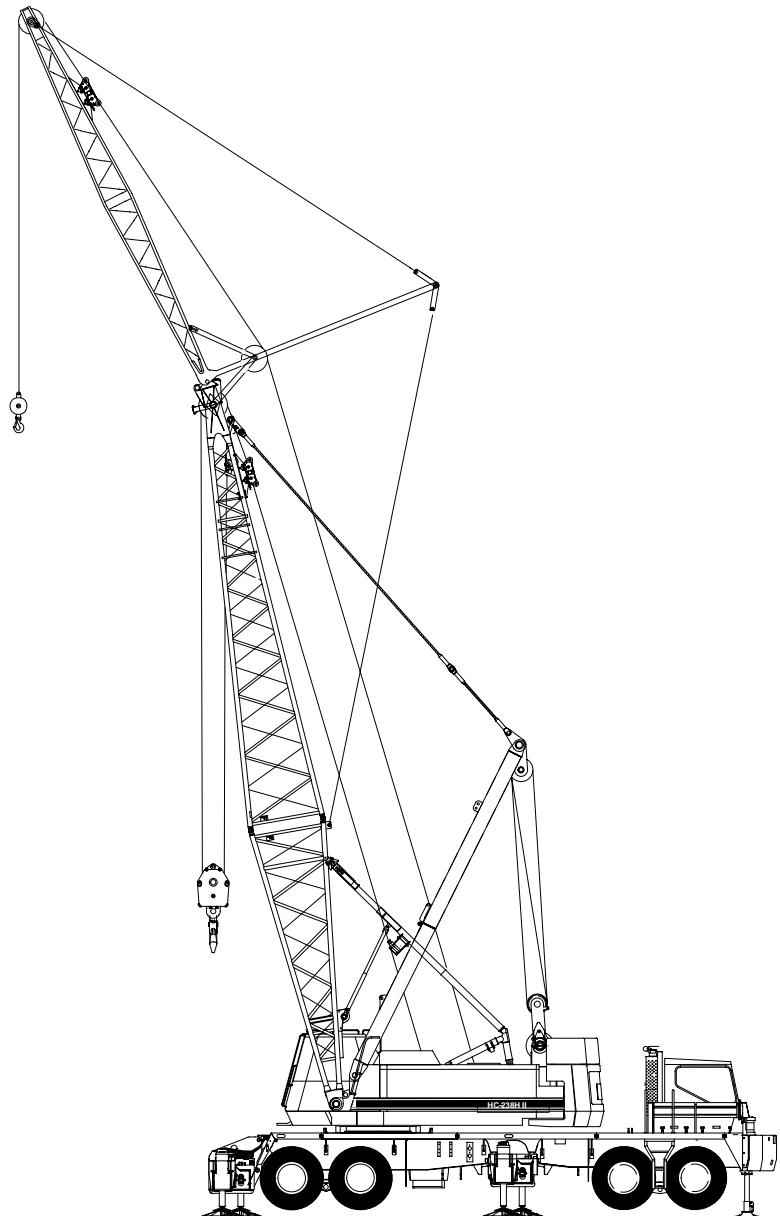

CAUTION: This material is supplied for reference use only. Operator must refer to in-cab Crane Rating Manual to determine allowable machine lifting capacities and operating procedures.

TUBULAR JIB NOTES FOR OPEN THROAT BOOM

1. Capacities are for a HC – 238H II Truck Crane with “ABC + 0” (63,440 lb + 0) and “ABC+A” (63,440 lb + 13,500 lb) Counterweight. Verify crane counterweight configuration and consult proper jib capacity chart prior to lifting loads.
2. Capacities are for Truck Crane working areas for 360°, described on the working area chart found in the General Information Section of the Crane Rating Manual and are based on crane standing level on outriggers on firm supporting surface.
3. Capacities are limited to a LBCE 62” x 70” tubular boom with an open throat and a LBCE 24” x 32” cross-section jib with jib mast properly assembled.
4. Two parts of 7/8” Diameter Type “N”, Type “DB”, or Type “RB” wire rope are required for maximum lift.
5. Capacities are for 30’, 45’, 60’, and 75’ jib lengths only.
6. A jib cannot be used on open throat boom lengths longer than 230’.
7. The least stable condition is over the side.
8. All capacities are in pounds and are not more than 85% of the tipping loads. Those capacities in the shaded areas are governed by factors other than those that would cause a tipping condition.
9. A deduction must be made from the jib capacities for the weight of the following: Main boom hook block or hook ball, jib hook block or hook ball, slings, grapple, load weighing devices, etc.

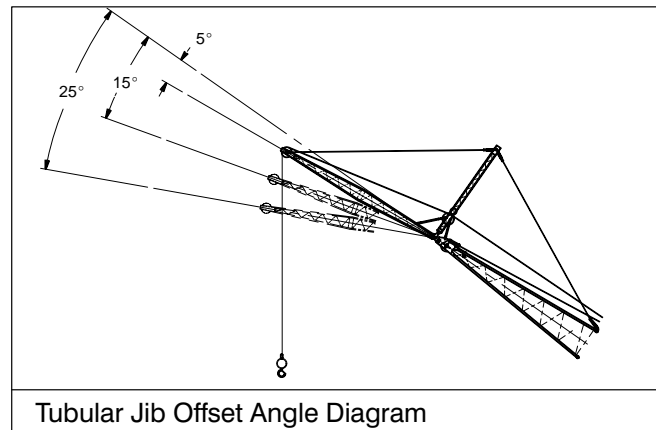
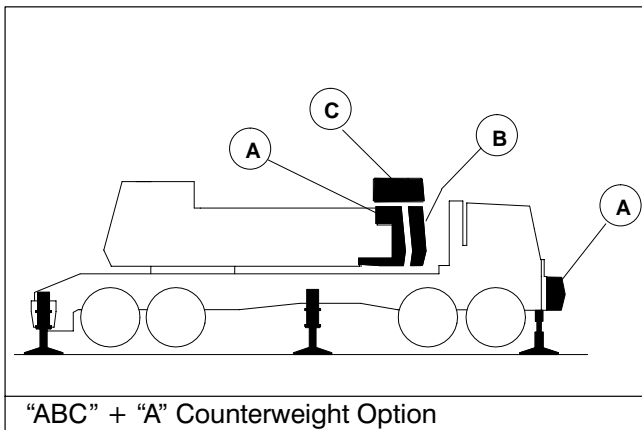

WORKING RANGE DIAGRAM

50' TO 230' OPEN THROAT BOOM WITH 30'–75' JIB

MAXIMUM BOOM ANGLE
ANGLE SEE NOTE 2

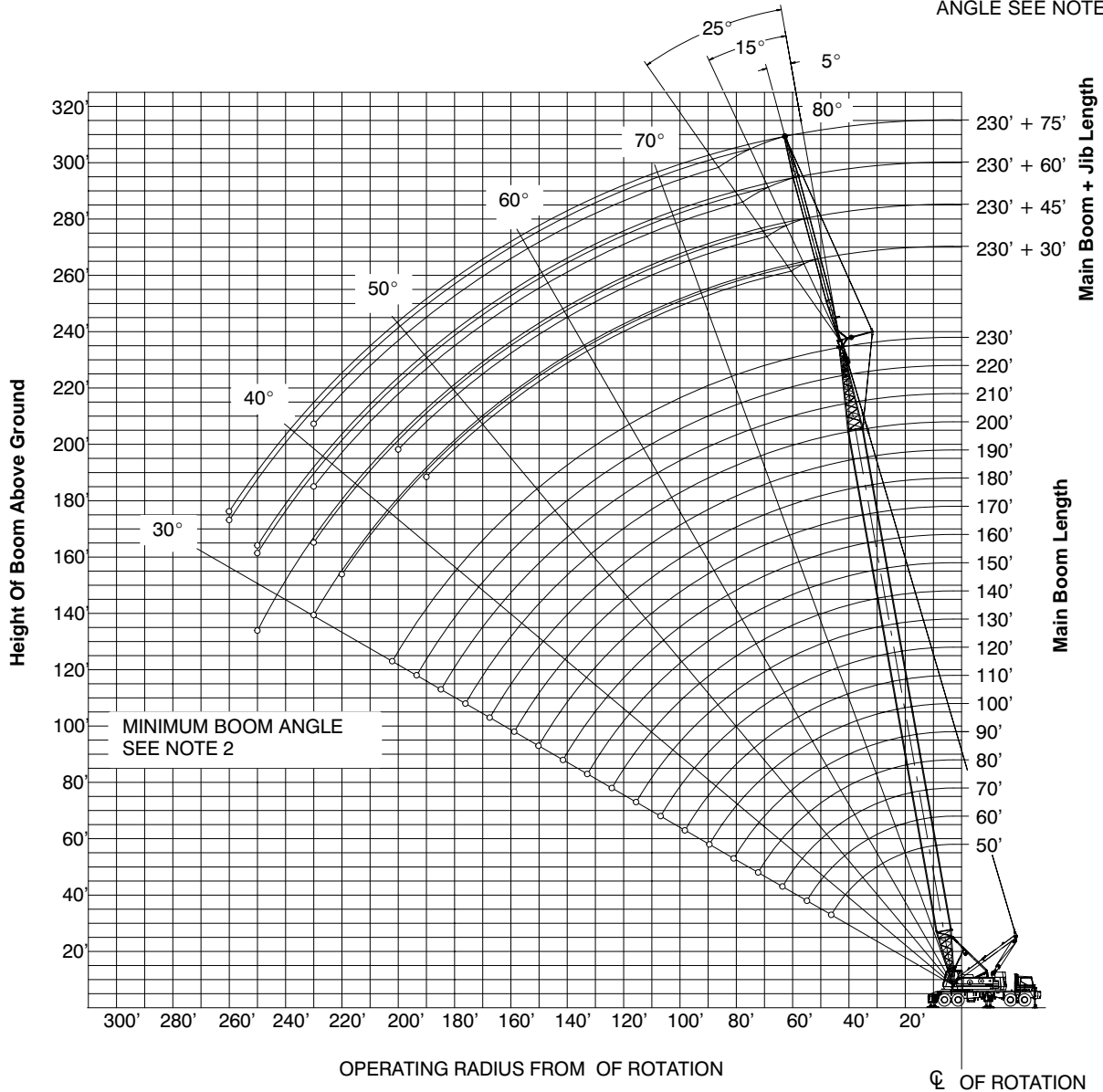

Notes:

1. Boom geometry shown is for unloaded condition and crane standing level on firm supporting surface. Boom deflection, subsequent radius, and boom angle change must be accounted for when applying load to hook.
2. Maximum and minimum boom angles are equal to the values listed in the capacity chart for each boom length.

HC-238H II - w/ 62" x 70" Tube Boom, w/ 24" x 32" Tube Jib, w/ ABC + A Cwt

General Use Only. Refer to the Tubular Jib Notes for Open Throat Boom before operating the machine.

Boom Length (ft)	Jib Length (ft)	Jib Load Radius (ft)	Jib Angle to Boom								
			5 Degrees			15 Degrees			25 Degrees		
			Boom Angle (deg)	Jib Pt Height (ft)	Jib Capacity ABC + A (lbs)	Boom Angle (deg)	Jib Pt Height (ft)	Jib Capacity ABC + A (lbs)	Boom Angle (deg)	Jib Pt Height (ft)	Jib Capacity ABC + A (lbs)
50	30	19.79	80.0	87.1	24,000						
50	30	20	79.9	87.1	24,000						
50	30	25	76.3	85.8	24,000	79.8	85.3	24,000			
50	30	30	72.6	84.2	24,000	76.1	83.7	24,000	79.4	82.3	22,600
50	30	35	68.9	82.3	24,000	72.3	81.7	24,000	75.6	80.3	22,000
50	30	40	65.0	79.9	24,000	68.5	79.4	23,900	71.6	77.9	20,300
50	30	50	56.9	73.9	24,000	60.2	73.3	22,300	63.3	71.7	17,400
50	30	60	47.9	65.6	22,700	51.1	65.0	19,000	53.9	63.1	15,400
50	30	70	37.1	54.0	19,400	40.2	53.1	16,700			
50	45	23.67	80.0	101.3	24,000						
50	45	25	79.2	101.0	24,000						
50	45	30	76.1	99.6	24,000						
50	45	35	73.1	97.9	24,000	77.5	97.1	20,600			
50	45	40	69.9	95.9	22,600	74.3	95.1	18,400	78.6	93.2	13,700
50	45	50	63.4	90.9	19,000	67.7	90.1	15,300	71.9	88.1	11,800
50	45	60	56.4	84.4	15,800	60.7	83.6	13,100	64.6	81.3	10,400
50	45	70	48.7	75.9	13,500	52.9	75.0	11,500	56.6	72.5	9,400
50	45	80	39.8	64.6	11,800	43.9	63.6	10,300	47.3	60.7	8,600
50	45	90	28.7	48.4	10,600						
50	60	27.55	80.0	115.8	24,000						
50	60	30	78.7	115.2	22,900						
50	60	35	76.1	113.7	22,200						
50	60	40	73.4	112.0	19,400	78.6	111.2	14,900			
50	60	50	67.9	107.9	15,500	73.0	107.0	12,300	78.0	104.7	9,400
50	60	60	62.1	102.5	12,800	67.2	101.6	10,500	72.0	99.2	8,200
50	60	70	56.0	95.7	10,900	61.0	94.8	9,100	65.7	92.2	7,300
50	60	80	49.3	87.1	9,500	54.2	86.2	8,100	58.7	83.3	6,600
50	60	90	41.8	76.2	8,400	46.6	75.1	7,300	50.8	71.8	6,000
50	60	100	32.7	61.6	7,600	37.3	60.2	6,700			
50	75	31.44	80.0	130.6	20,700						
50	75	35	78.3	129.8	20,100						
50	75	40	76.0	128.3	17,500						
50	75	50	71.2	124.8	13,800	77.0	124.0	10,900			
50	75	60	66.3	120.3	11,300	72.0	119.5	9,200	77.5	117.0	7,000
50	75	70	61.1	114.7	9,600	66.8	113.9	7,900	72.1	111.2	6,100
50	75	80	55.6	107.8	8,200	61.2	106.9	6,900	66.5	104.1	5,500

General Use Only. Refer to the Tubular Jib Notes for Open Throat Boom before operating the machine.

Boom Length (ft)	Jib Length (ft)	Jib Load Radius (ft)	Jib Angle to Boom								
			5 Degrees			15 Degrees			25 Degrees		
			Boom Angle (deg)	Jib Pt Height (ft)	Jib Capacity ABC + A (lbs)	Boom Angle (deg)	Jib Pt Height (ft)	Jib Capacity ABC + A (lbs)	Boom Angle (deg)	Jib Pt Height (ft)	Jib Capacity ABC + A (lbs)
50	75	90	49.7	99.3	7,200	55.2	98.3	6,100	60.3	95.2	4,900
50	75	100	43.2	88.7	6,400	48.6	87.7	5,500	53.5	84.1	4,500
50	75	110	35.6	75.1	5,800	40.8	73.8	5,000			
50	75	120	25.9	56.2	5,200						
60	30	21.53	80.0	97.0	24,000						
60	30	25	77.8	96.2	24,000						
60	30	30	74.6	94.8	24,000	77.7	94.2	24,000			
60	30	35	71.3	93.1	24,000	74.4	92.5	24,000	77.3	91.0	22,500
60	30	40	67.9	91.0	24,000	71.0	90.4	24,000	73.9	88.9	21,000
60	30	50	60.9	85.8	24,000	63.9	85.2	22,600	66.7	83.5	18,300
60	30	60	53.4	78.9	22,700	56.3	78.2	20,700	58.9	76.4	16,300
60	30	70	45.0	69.7	21,700	47.8	69.0	18,100	50.1	66.9	14,800
60	30	80	34.9	57.0	18,800	37.6	56.1	16,300			
60	45	25.41	80.0	111.1	24,000						
60	45	30	77.5	110.0	24,000						
60	45	35	74.7	108.5	24,000	78.7	107.6	21,500			
60	45	40	71.9	106.7	22,900	75.9	105.8	19,400	79.8	103.8	14,100
60	45	50	66.1	102.2	20,800	70.0	101.4	16,200	73.8	99.2	12,200
60	45	60	59.9	96.5	17,300	63.8	95.7	13,900	67.5	93.4	10,900
60	45	70	53.4	89.3	14,800	57.2	88.3	12,300	60.7	85.9	9,800
60	45	80	46.1	80.0	12,900	49.9	79.0	11,000	53.1	76.2	9,000
60	45	90	37.8	67.9	11,500	41.4	66.7	10,000			
60	45	100	27.2	50.7	10,500						
60	60	29.29	80.0	125.6	24,000						
60	60	30	79.7	125.5	24,000						
60	60	35	77.2	124.2	22,600						
60	60	40	74.8	122.6	20,800	79.6	121.7	15,500			
60	60	50	69.8	118.8	16,600	74.5	117.9	12,900	79.1	115.5	9,600
60	60	60	64.6	114.0	13,800	69.3	113.0	11,100	73.7	110.5	8,500
60	60	70	59.2	107.9	11,800	63.8	107.0	9,700	68.1	104.3	7,600
60	60	80	53.3	100.5	10,300	57.9	99.5	8,600	62.1	96.6	6,900
60	60	90	47.0	91.3	9,100	51.5	90.2	7,800	55.4	86.9	6,300
60	60	100	39.8	79.6	8,200	44.2	78.4	7,100	47.9	74.7	5,900
60	60	110	31.2	64.1	7,500						
60	75	33.17	80.0	140.5	20,600						

HC-238H II - w/ 62" x 70" Tube Boom, w/ 24" x 32" Tube Jib, w/ ABC + A Cwt

General Use Only. Refer to the Tubular Jib Notes for Open Throat Boom before operating the machine.

Boom Length (ft)	Jib Length (ft)	Jib Load Radius (ft)	Jib Angle to Boom								
			5 Degrees			15 Degrees			25 Degrees		
			Boom Angle (deg)	Jib Pt Height (ft)	Jib Capacity ABC + A (lbs)	Boom Angle (deg)	Jib Pt Height (ft)	Jib Capacity ABC + A (lbs)	Boom Angle (deg)	Jib Pt Height (ft)	Jib Capacity ABC + A (lbs)
80	45	100	42.0	87.6	12,200	45.1	86.4	10,400	47.6	83.1	8,600
80	45	110	34.4	73.9	11,100	37.3	72.5	9,700			
80	60	32.76	80.0	145.3	24,000						
80	60	35	79.1	144.8	23,300						
80	60	40	77.0	143.5	22,600						
80	60	50	72.8	140.3	18,800	76.8	139.2	13,900			
80	60	60	68.4	136.2	15,800	72.5	135.2	12,100	76.3	132.4	8,900
80	60	70	64.0	131.3	13,500	67.9	130.2	10,600	71.7	127.3	8,100
80	60	80	59.3	125.3	11,800	63.2	124.2	9,500	66.8	121.1	7,400
80	60	90	54.3	118.1	10,500	58.2	116.9	8,600	61.7	113.7	6,800
80	60	100	49.0	109.5	9,400	52.9	108.2	7,900	56.2	104.8	6,300
80	60	110	43.2	99.0	8,600	47.0	97.6	7,300	50.1	93.8	6,000
80	60	120	36.7	86.0	7,900	40.2	84.4	6,800			
80	60	130	28.7	69.0	7,300						
80	75	36.65	80.0	160.2	20,400						
80	75	40	78.7	159.4	20,000						
80	75	50	75.0	156.6	16,500	79.6	155.5	12,000			
80	75	60	71.1	153.1	13,700	75.7	152.0	10,300			
80	75	70	67.1	148.8	11,600	71.7	147.7	9,000	76.0	144.6	6,700
80	75	80	63.0	143.6	10,100	67.5	142.5	8,000	71.8	139.3	6,000
80	75	90	58.7	137.4	8,900	63.2	136.3	7,200	67.4	132.9	5,500
80	75	100	54.2	130.2	7,900	58.7	129.0	6,500	62.7	125.4	5,100
80	75	110	49.4	121.6	7,100	53.8	120.3	5,900	57.7	116.5	4,700
80	75	120	44.2	111.4	6,500	48.5	110.0	5,500	52.2	105.8	4,400
80	75	130	38.4	99.0	5,900	42.6	97.4	5,100	46.1	92.6	4,100
80	75	140	31.7	83.4	5,500	35.6	81.3	4,800			
90	30	26.74	80.0	126.5	24,000						
90	30	30	78.4	125.8	24,000						
90	30	35	76.0	124.6	24,000	78.4	123.9	24,000			
90	30	40	73.6	123.1	24,000	75.9	122.4	24,000	78.1	120.8	22,500
90	30	50	68.6	119.4	24,000	70.9	118.7	24,000	73.0	117.0	20,400
90	30	60	63.4	114.6	24,000	65.7	113.9	22,600	67.7	112.1	18,600
90	30	70	57.9	108.7	24,000	60.2	107.9	22,200	62.1	106.1	17,000
90	30	80	52.1	101.3	22,600	54.3	100.5	19,900	56.2	98.5	15,700
90	30	90	45.8	92.2	21,900	47.9	91.3	18,100	49.6	89.1	14,700
90	30	100	38.6	80.6	19,700	40.6	79.7	16,700			

General Use Only. Refer to the Tubular Jib Notes for Open Throat Boom before operating the machine.

Boom Length (ft)	Jib Length (ft)	Jib Load Radius (ft)	Jib Angle to Boom								
			5 Degrees			15 Degrees			25 Degrees		
			Boom Angle (deg)	Jib Pt Height (ft)	Jib Capacity ABC + A (lbs)	Boom Angle (deg)	Jib Pt Height (ft)	Jib Capacity ABC + A (lbs)	Boom Angle (deg)	Jib Pt Height (ft)	Jib Capacity ABC + A (lbs)
90	30	110	30.0	65.3	17,900						
90	45	30.62	80.0	140.7	24,000						
90	45	35	78.1	139.6	24,000						
90	45	40	76.0	138.3	24,000	79.1	137.3	21,700			
90	45	50	71.6	134.9	22,600	74.7	133.9	18,600	77.6	131.6	13,300
90	45	60	67.1	130.7	21,400	70.1	129.7	16,200	73.0	127.3	12,000
90	45	70	62.4	125.5	18,400	65.4	124.5	14,400	68.2	122.0	10,900
90	45	80	57.5	119.2	16,200	60.5	118.2	13,000	63.2	115.5	10,100
90	45	90	52.2	111.6	14,400	55.2	110.5	11,800	57.8	107.7	9,400
90	45	100	46.6	102.4	13,000	49.5	101.3	10,900	51.9	98.2	8,900
90	45	110	40.3	91.1	11,900	43.1	89.8	10,200			
90	45	120	33.0	76.8	11,000						
90	60	34.5	80.0	155.2	24,000						
90	60	35	79.8	155.1	24,000						
90	60	40	77.9	153.8	22,500						
90	60	50	74.0	150.9	19,900	77.7	149.7	14,400			
90	60	60	69.9	147.1	16,700	73.7	146.0	12,500	77.3	143.2	9,100
90	60	70	65.8	142.5	14,300	69.5	141.4	11,100	73.0	138.5	8,300
90	60	80	61.5	137.1	12,600	65.2	135.9	10,000	68.6	132.8	7,600
90	60	90	57.1	130.5	11,200	60.7	129.3	9,000	64.0	126.1	7,000
90	60	100	52.3	122.8	10,000	55.9	121.6	8,300	59.1	118.2	6,500
90	60	110	47.2	113.7	9,100	50.8	112.3	7,600	53.8	108.6	6,200
90	60	120	41.7	102.6	8,400	45.1	101.2	7,100	47.9	97.1	5,800
90	60	130	35.3	89.0	7,700	38.6	87.3	6,700			
90	60	140	27.7	71.3	7,200						
90	75	38.38	80.0	170.0	20,300						
90	75	40	79.4	169.7	20,100						
90	75	50	75.9	167.1	17,300						
90	75	60	72.3	163.8	14,400	76.6	162.6	10,700			
90	75	70	68.6	159.7	12,300	72.9	158.6	9,400	77.0	155.5	6,800
90	75	80	64.8	154.9	10,700	69.0	153.8	8,300	73.0	150.5	6,200
90	75	90	60.8	149.3	9,400	65.1	148.1	7,500	69.0	144.7	5,700
90	75	100	56.7	142.7	8,400	60.9	141.4	6,800	64.7	137.8	5,200
90	75	110	52.4	134.9	7,600	56.5	133.6	6,200	60.2	129.8	4,900
90	75	120	47.8	125.8	6,900	51.8	124.5	5,700	55.4	120.3	4,500
90	75	130	42.7	115.1	6,300	46.7	113.6	5,300	50.1	109.0	4,300

HC-238H II - w/ 62" x 70" Tube Boom, w/ 24" x 32" Tube Jib, w/ ABC + A Cwt

General Use Only. Refer to the Tubular Jib Notes for Open Throat Boom before operating the machine.

Boom Length (ft)	Jib Length (ft)	Jib Load Radius (ft)	Jib Angle to Boom								
			5 Degrees			15 Degrees			25 Degrees		
			Boom Angle (deg)	Jib Pt Height (ft)	Jib Capacity ABC + A (lbs)	Boom Angle (deg)	Jib Pt Height (ft)	Jib Capacity ABC + A (lbs)	Boom Angle (deg)	Jib Pt Height (ft)	Jib Capacity ABC + A (lbs)
90	75	140	37.1	102.2	5,800	41.0	100.4	5,000			
90	75	150	30.6	85.9	5,400						
100	30	28.47	80.0	136.4	24,000						
100	30	30	79.3	136.1	24,000						
100	30	35	77.1	134.9	24,000	79.3	134.2	24,000			
100	30	40	74.9	133.5	24,000	77.0	132.8	24,000	79.0	131.2	22,600
100	30	50	70.3	130.1	24,000	72.4	129.4	24,000	74.4	127.7	20,800
100	30	60	65.6	125.8	24,000	67.7	125.1	23,300	69.6	123.3	19,100
100	30	70	60.6	120.5	24,000	62.7	119.7	22,600	64.6	117.9	17,600
100	30	80	55.5	113.9	23,600	57.5	113.1	21,100	59.3	111.2	16,300
100	30	90	49.9	105.9	22,600	51.9	105.1	19,200	53.6	103.0	15,200
100	30	100	43.9	96.2	21,200	45.8	95.3	17,700	47.3	92.9	14,400
100	30	110	37.0	83.9	19,300	38.9	82.9	16,500			
100	30	120	28.8	67.8	17,700						
100	45	32.35	80.0	150.5	24,000						
100	45	35	78.9	149.9	24,000						
100	45	40	76.9	148.7	24,000	79.9	147.6	22,400			
100	45	50	72.9	145.6	23,800	75.8	144.5	19,200	78.5	142.1	13,600
100	45	60	68.7	141.7	22,600	71.6	140.6	16,800	74.3	138.2	12,300
100	45	70	64.4	136.9	19,600	67.3	135.9	15,000	69.9	133.3	11,300
100	45	80	59.9	131.2	17,200	62.8	130.1	13,600	65.3	127.4	10,400
100	45	90	55.3	124.3	15,300	58.0	123.2	12,400	60.5	120.4	9,700
100	45	100	50.3	116.2	13,900	53.0	115.0	11,400	55.3	112.0	9,100
100	45	110	44.8	106.4	12,600	47.5	105.2	10,600	49.7	101.9	8,700
100	45	120	38.8	94.6	11,600	41.4	93.1	10,000			
100	45	130	31.8	79.5	10,800						
100	60	36.24	80.0	165.0	24,000						
100	60	40	78.6	164.2	22,600						
100	60	50	75.0	161.4	20,900	78.5	160.2	14,800			
100	60	60	71.2	157.9	17,600	74.8	156.7	13,000	78.1	153.8	9,300
100	60	70	67.4	153.6	15,100	70.9	152.4	11,500	74.2	149.5	8,500
100	60	80	63.5	148.6	13,300	66.9	147.4	10,400	70.1	144.3	7,800
100	60	90	59.4	142.6	11,800	62.8	141.4	9,400	65.9	138.1	7,200
100	60	100	55.1	135.6	10,600	58.5	134.3	8,600	61.5	130.9	6,700
100	60	110	50.5	127.4	9,700	53.8	126.1	8,000	56.8	122.4	6,300
100	60	120	45.6	117.7	8,900	48.9	116.3	7,400	51.7	112.4	6,000

General Use Only. Refer to the Tubular Jib Notes for Open Throat Boom before operating the machine.

Boom Length (ft)	Jib Length (ft)	Jib Load Radius (ft)	Jib Angle to Boom								
			5 Degrees			15 Degrees			25 Degrees		
			Boom Angle (deg)	Jib Pt Height (ft)	Jib Capacity ABC + A (lbs)	Boom Angle (deg)	Jib Pt Height (ft)	Jib Capacity ABC + A (lbs)	Boom Angle (deg)	Jib Pt Height (ft)	Jib Capacity ABC + A (lbs)
100	60	130	40.2	106.2	8,200	43.4	104.6	7,000			
100	60	140	34.1	92.0	7,600	37.2	90.1	6,600			
100	60	150	26.7	73.5	7,200						
100	75	40.12	80.0	179.9	20,100						
100	75	50	76.7	177.4	18,100						
100	75	60	73.3	174.4	15,100	77.4	173.2	11,000			
100	75	70	69.9	170.6	12,900	73.9	169.4	9,700	77.8	166.2	7,000
100	75	80	66.3	166.1	11,300	70.3	164.9	8,600	74.1	161.6	6,300
100	75	90	62.7	160.9	10,000	66.7	159.7	7,800	70.4	156.2	5,800
100	75	100	58.9	154.8	8,900	62.8	153.5	7,100	66.5	149.9	5,400
100	75	110	54.9	147.7	8,000	58.8	146.4	6,500	62.4	142.5	5,000
100	75	120	50.7	139.5	7,300	54.6	138.1	6,000	58.0	134.0	4,700
100	75	130	46.3	130.0	6,700	50.1	128.5	5,600	53.3	124.1	4,400
100	75	140	41.4	118.7	6,200	45.1	117.1	5,200	48.2	112.2	4,200
100	75	150	36.0	105.2	5,700	39.6	103.3	4,900			
100	75	160	29.6	88.4	5,400						
110	30	30.21	80.0	146.2	24,000						
110	30	35	78.0	145.2	24,000						
110	30	40	75.9	143.9	24,000	78.0	143.2	24,000	79.9	141.5	22,600
110	30	50	71.7	140.8	24,000	73.7	140.1	24,000	75.6	138.4	21,200
110	30	60	67.4	136.8	24,000	69.4	136.1	24,000	71.2	134.3	19,600
110	30	70	62.9	131.9	24,000	64.9	131.2	22,600	66.6	129.3	18,200
110	30	80	58.2	126.0	24,000	60.1	125.3	22,200	61.8	123.3	16,800
110	30	90	53.3	118.9	22,500	55.2	118.1	20,200	56.8	116.0	15,800
110	30	100	48.0	110.4	22,600	49.8	109.5	18,600	51.3	107.3	14,900
110	30	110	42.2	100.0	20,700	44.0	99.0	17,300			
110	30	120	35.6	87.1	18,900	37.3	86.0	16,200			
110	30	130	27.7	70.2	16,800						
110	45	34.09	80.0	160.4	24,000						
110	45	35	79.7	160.2	24,000						
110	45	40	77.8	159.0	24,000						
110	45	50	74.0	156.1	24,000	76.7	155.0	19,900	79.3	152.6	13,900
110	45	60	70.1	152.5	22,500	72.8	151.4	17,500	75.4	148.9	12,600
110	45	70	66.2	148.1	20,800	68.8	147.0	15,600	71.3	144.4	11,600
110	45	80	62.1	142.8	18,200	64.7	141.7	14,100	67.1	139.1	10,700
110	45	90	57.8	136.6	16,300	60.4	135.5	12,900	62.7	132.7	10,000

HC-238H II - w/ 62" x 70" Tube Boom, w/ 24" x 32" Tube Jib, w/ ABC + A Cwt

General Use Only. Refer to the Tubular Jib Notes for Open Throat Boom before operating the machine.

Boom Length (ft)	Jib Length (ft)	Jib Load Radius (ft)	Jib Angle to Boom								
			5 Degrees			15 Degrees			25 Degrees		
			Boom Angle (deg)	Jib Pt Height (ft)	Jib Capacity ABC + A (lbs)	Boom Angle (deg)	Jib Pt Height (ft)	Jib Capacity ABC + A (lbs)	Boom Angle (deg)	Jib Pt Height (ft)	Jib Capacity ABC + A (lbs)
110	45	100	53.3	129.3	14,700	55.9	128.1	11,900	58.1	125.2	9,400
110	45	110	48.5	120.6	13,400	51.0	119.4	11,100	53.1	116.2	8,900
110	45	120	43.3	110.3	12,300	45.7	109.0	10,400	47.7	105.6	8,600
110	45	130	37.5	97.8	11,500	39.8	96.3	9,800			
110	45	140	30.7	82.1	10,700						
110	60	37.97	80.0	174.9	24,000						
110	60	40	79.3	174.4	23,500						
110	60	50	75.9	171.8	21,900	79.2	170.6	15,200			
110	60	60	72.4	168.5	18,500	75.7	167.3	13,300	78.9	164.4	9,500
110	60	70	68.8	164.6	15,900	72.1	163.4	11,900	75.2	160.3	8,700
110	60	80	65.1	159.9	14,000	68.4	158.6	10,700	71.5	155.5	8,000
110	60	90	61.4	154.4	12,500	64.6	153.1	9,800	67.6	149.8	7,400
110	60	100	57.4	147.9	11,200	60.6	146.6	9,000	63.5	143.2	6,900
110	60	110	53.3	140.5	10,200	56.4	139.1	8,300	59.2	135.5	6,500
110	60	120	48.9	131.8	9,400	52.0	130.4	7,700	54.7	126.6	6,200
110	60	130	44.2	121.6	8,700	47.2	120.1	7,300	49.7	116.0	5,900
110	60	140	39.0	109.6	8,100	41.9	107.8	6,900			
110	60	150	33.0	94.8	7,500						
110	75	41.86	80.0	189.7	20,000						
110	75	50	77.4	187.8	18,900						
110	75	60	74.2	184.9	15,800	78.1	183.6	11,300			
110	75	70	71.0	181.3	13,600	74.8	180.1	10,000	78.5	176.8	7,100
110	75	80	67.7	177.2	11,800	71.5	175.9	8,900	75.1	172.5	6,500
110	75	90	64.3	172.3	10,500	68.0	171.0	8,100	71.6	167.5	6,000
110	75	100	60.8	166.6	9,400	64.5	165.3	7,400	67.9	161.6	5,500
110	75	110	57.1	160.1	8,500	60.8	158.7	6,800	64.2	154.9	5,100
110	75	120	53.3	152.6	7,700	56.9	151.2	6,200	60.2	147.1	4,800
110	75	130	49.2	143.9	7,100	52.8	142.4	5,800	56.0	138.1	4,500
110	75	140	44.9	133.9	6,500	48.4	132.3	5,400	51.5	127.7	4,300
110	75	150	40.2	122.2	6,100	43.6	120.4	5,100	46.5	115.3	4,100
110	75	160	34.9	108.2	5,700	38.3	106.1	4,800			
110	75	170	28.8	90.8	5,300						
120	30	31.95	80.0	156.1	24,000						
120	30	35	78.8	155.4	24,000						
120	30	40	76.9	154.3	24,000	78.8	153.5	24,000			
120	30	50	73.0	151.3	24,000	74.8	150.6	24,000	76.6	148.9	21,600

General Use Only. Refer to the Tubular Jib Notes for Open Throat Boom before operating the machine.

Boom Length (ft)	Jib Length (ft)	Jib Load Radius (ft)	Jib Angle to Boom								
			5 Degrees			15 Degrees			25 Degrees		
			Boom Angle (deg)	Jib Pt Height (ft)	Jib Capacity ABC + A (lbs)	Boom Angle (deg)	Jib Pt Height (ft)	Jib Capacity ABC + A (lbs)	Boom Angle (deg)	Jib Pt Height (ft)	Jib Capacity ABC + A (lbs)
120	30	60	69.0	147.7	24,000	70.8	146.9	24,000	72.5	145.2	20,000
120	30	70	64.8	143.2	24,000	66.7	142.4	22,600	68.3	140.6	18,700
120	30	80	60.6	137.8	24,000	62.4	137.0	22,600	63.9	135.1	17,400
120	30	90	56.1	131.3	23,900	57.8	130.5	21,200	59.4	128.5	16,300
120	30	100	51.4	123.7	22,600	53.1	122.9	19,500	54.5	120.7	15,300
120	30	110	46.3	114.6	21,400	48.0	113.7	18,100	49.3	111.4	14,600
120	30	120	40.7	103.7	18,800	42.3	102.7	17,000			
120	30	130	34.4	90.2	16,600	35.9	89.0	16,000			
120	30	140	26.7	72.5	14,700						
120	45	35.83	80.0	170.2	24,000						
120	45	40	78.5	169.3	24,000						
120	45	50	75.0	166.6	24,000	77.6	165.5	20,400			
120	45	60	71.4	163.2	22,400	73.9	162.1	18,100	76.3	159.6	12,800
120	45	70	67.7	159.1	21,900	70.2	158.0	16,200	72.5	155.4	11,800
120	45	80	63.9	154.2	19,300	66.4	153.1	14,700	68.7	150.4	11,000
120	45	90	60.0	148.5	17,200	62.4	147.4	13,400	64.6	144.6	10,300
120	45	100	55.8	141.8	15,500	58.3	140.6	12,400	60.4	137.7	9,700
120	45	110	51.5	134.0	14,200	53.9	132.8	11,600	55.9	129.7	9,200
120	45	120	46.9	124.8	13,000	49.2	123.6	10,800	51.2	120.3	8,800
120	45	130	41.9	114.0	12,100	44.1	112.6	10,200			
120	45	140	36.3	101.0	11,300	38.4	99.4	9,700			
120	45	150	29.7	84.7	10,600						
120	60	39.71	80.0	184.7	24,000						
120	60	40	79.9	184.7	24,000						
120	60	50	76.7	182.2	22,500	79.8	180.9	15,600			
120	60	60	73.4	179.1	19,300	76.5	177.9	13,700	79.5	174.9	9,600
120	60	70	70.0	175.4	16,700	73.2	174.1	12,300	76.1	171.1	8,800
120	60	80	66.6	171.0	14,700	69.7	169.7	11,100	72.6	166.6	8,200
120	60	90	63.1	165.9	13,100	66.2	164.6	10,100	69.0	161.3	7,600
120	60	100	59.4	159.9	11,800	62.5	158.6	9,300	65.2	155.2	7,100
120	60	110	55.6	153.1	10,800	58.6	151.7	8,600	61.3	148.2	6,700
120	60	120	51.6	145.2	9,900	54.6	143.8	8,100	57.2	140.0	6,400
120	60	130	47.4	136.1	9,100	50.3	134.6	7,600	52.8	130.5	6,100
120	60	140	42.8	125.4	8,500	45.7	123.8	7,100	48.0	119.5	5,800
120	60	150	37.8	112.8	7,900	40.5	111.0	6,800			
120	60	160	32.1	97.5	7,500						

HC-238H II - w/ 62" x 70" Tube Boom, w/ 24" x 32" Tube Jib, w/ ABC + A Cwt

General Use Only. Refer to the Tubular Jib Notes for Open Throat Boom before operating the machine.

Boom Length (ft)	Jib Length (ft)	Jib Load Radius (ft)	Jib Angle to Boom								
			5 Degrees			15 Degrees			25 Degrees		
			Boom Angle (deg)	Jib Pt Height (ft)	Jib Capacity ABC + A (lbs)	Boom Angle (deg)	Jib Pt Height (ft)	Jib Capacity ABC + A (lbs)	Boom Angle (deg)	Jib Pt Height (ft)	Jib Capacity ABC + A (lbs)
120	75	43.59	80.0	199.6	19,900						
120	75	50	78.1	198.1	19,300						
120	75	60	75.1	195.4	16,500	78.7	194.1	11,600			
120	75	70	72.0	192.0	14,200	75.7	190.7	10,300	79.1	187.4	7,200
120	75	80	68.9	188.1	12,400	72.5	186.8	9,200	75.9	183.3	6,600
120	75	90	65.7	183.5	11,000	69.3	182.2	8,300	72.6	178.6	6,100
120	75	100	62.4	178.2	9,900	66.0	176.8	7,600	69.2	173.1	5,700
120	75	110	59.0	172.1	8,900	62.5	170.7	7,000	65.7	166.9	5,300
120	75	120	55.5	165.2	8,100	59.0	163.8	6,500	62.1	159.7	5,000
120	75	130	51.8	157.3	7,500	55.2	155.8	6,000	58.3	151.5	4,700
120	75	140	47.8	148.2	6,900	51.2	146.6	5,700	54.2	142.1	4,400
120	75	150	43.6	137.8	6,400	47.0	136.1	5,300	49.8	131.2	4,200
120	75	160	39.1	125.6	6,000	42.3	123.7	5,000			
120	75	170	33.9	111.1	5,600	37.1	108.9	4,800			
120	75	180	28.0	93.1	5,300						
130	30	33.68	80.0	165.9	24,000						
130	30	35	79.5	165.7	24,000						
130	30	40	77.7	164.5	24,000	79.5	163.8	24,000			
130	30	50	74.1	161.8	24,000	75.8	161.1	24,000	77.4	159.4	21,900
130	30	60	70.3	158.4	24,000	72.1	157.7	24,000	73.7	155.9	20,300
130	30	70	66.5	154.2	24,000	68.2	153.5	23,500	69.8	151.7	19,000
130	30	80	62.6	149.3	24,000	64.2	148.5	22,600	65.7	146.6	17,900
130	30	90	58.5	143.4	24,000	60.1	142.6	22,100	61.6	140.6	16,800
130	30	100	54.2	136.4	22,900	55.8	135.6	20,400	57.2	133.5	15,800
130	30	110	49.6	128.3	21,100	51.2	127.4	18,900	52.5	125.2	15,000
130	30	120	44.7	118.7	18,500	46.3	117.8	17,700	47.5	115.3	14,300
130	30	130	39.3	107.2	16,300	40.8	106.2	16,500			
130	30	140	33.2	93.1	14,500						
130	30	150	25.9	74.7	12,900						
130	45	37.56	80.0	180.1	24,000						
130	45	40	79.2	179.5	24,000						
130	45	50	75.9	177.0	24,000	78.3	175.9	21,000			
130	45	60	72.5	173.8	23,300	74.9	172.7	18,600	77.1	170.2	13,100
130	45	70	69.0	170.0	22,500	71.4	168.9	16,700	73.6	166.3	12,100
130	45	80	65.5	165.4	20,300	67.8	164.3	15,200	70.0	161.6	11,200
130	45	90	61.8	160.1	18,100	64.2	159.0	13,900	66.3	156.2	10,500
130	45	100	58.0	154.0	16,400	60.4	152.8	12,900	62.4	149.9	9,900

General Use Only. Refer to the Tubular Jib Notes for Open Throat Boom before operating the machine.

Boom Length (ft)	Jib Length (ft)	Jib Load Radius (ft)	Jib Angle to Boom								
			5 Degrees			15 Degrees			25 Degrees		
			Boom Angle (deg)	Jib Pt Height (ft)	Jib Capacity ABC + A (lbs)	Boom Angle (deg)	Jib Pt Height (ft)	Jib Capacity ABC + A (lbs)	Boom Angle (deg)	Jib Pt Height (ft)	Jib Capacity ABC + A (lbs)
130	45	110	54.1	146.8	14,900	56.4	145.6	12,000	58.3	142.6	9,400
130	45	120	49.9	138.5	13,700	52.1	137.3	11,200	54.0	134.1	9,000
130	45	130	45.4	128.9	12,700	47.6	127.6	10,600	49.4	124.2	8,600
130	45	140	40.6	117.6	11,900	42.7	116.2	10,100			
130	45	150	35.1	104.1	11,200	37.2	102.4	9,600			
130	45	160	28.8	87.2	10,500						
130	60	41.45	80.0	194.6	24,000						
130	60	50	77.4	192.5	22,500						
130	60	60	74.3	189.6	20,200	77.3	188.3	14,100			
130	60	70	71.1	186.2	17,500	74.1	184.9	12,600	76.9	181.7	9,000
130	60	80	67.9	182.0	15,400	70.9	180.7	11,400	73.6	177.5	8,300
130	60	90	64.6	177.2	13,700	67.5	175.9	10,500	70.2	172.6	7,800
130	60	100	61.2	171.7	12,400	64.1	170.3	9,600	66.7	166.9	7,300
130	60	110	57.7	165.3	11,300	60.5	163.9	8,900	63.1	160.4	6,900
130	60	120	54.0	158.0	10,400	56.8	156.6	8,300	59.3	152.9	6,500
130	60	130	50.2	149.7	9,600	52.9	148.2	7,800	55.3	144.3	6,200
130	60	140	46.0	140.2	8,900	48.8	138.6	7,400	51.0	134.4	5,900
130	60	150	41.6	129.1	8,300	44.3	127.4	7,000			
130	60	160	36.7	116.0	7,800	39.3	114.1	6,700			
130	60	170	31.1	100.2	7,400						
130	75	45.33	80.0	209.4	19,700						
130	75	50	78.7	208.4	19,300						
130	75	60	75.8	205.8	17,200	79.3	204.4	11,800			
130	75	70	72.9	202.6	14,800	76.4	201.3	10,500	79.7	197.9	7,300
130	75	80	70.0	198.9	13,000	73.4	197.6	9,500	76.7	194.0	6,700
130	75	90	67.0	194.6	11,500	70.4	193.2	8,600	73.6	189.6	6,200
130	75	100	63.9	189.6	10,300	67.3	188.2	7,900	70.4	184.5	5,800
130	75	110	60.7	183.9	9,300	64.0	182.5	7,200	67.1	178.6	5,400
130	75	120	57.4	177.5	8,500	60.7	176.0	6,700	63.7	172.0	5,100
130	75	130	54.0	170.1	7,800	57.3	168.6	6,300	60.2	164.4	4,800
130	75	140	50.4	161.8	7,200	53.6	160.3	5,900	56.5	155.8	4,600
130	75	150	46.6	152.4	6,700	49.8	150.7	5,500	52.5	146.0	4,300
130	75	160	42.5	141.5	6,300	45.6	139.7	5,200	48.2	134.6	4,200
130	75	170	38.0	128.9	5,900	41.1	126.9	5,000			
130	75	180	33.0	113.9	5,500	36.0	111.6	4,700			
130	75	190	27.2	95.4	5,200						

HC-238H II - w/ 62" x 70" Tube Boom, w/ 24" x 32" Tube Jib, w/ ABC + A Cwt

General Use Only. Refer to the Tubular Jib Notes for Open Throat Boom before operating the machine.

Boom Length (ft)	Jib Length (ft)	Jib Load Radius (ft)	Jib Angle to Boom								
			5 Degrees			15 Degrees			25 Degrees		
			Boom Angle (deg)	Jib Pt Height (ft)	Jib Capacity ABC + A (lbs)	Boom Angle (deg)	Jib Pt Height (ft)	Jib Capacity ABC + A (lbs)	Boom Angle (deg)	Jib Pt Height (ft)	Jib Capacity ABC + A (lbs)
140	30	35.42	80.0	175.8	24,000						
140	30	40	78.4	174.8	24,000						
140	30	50	75.0	172.3	24,000	76.7	171.5	24,000	78.2	169.8	22,200
140	30	60	71.5	169.1	24,000	73.2	168.3	24,000	74.7	166.5	20,700
140	30	70	67.9	165.2	24,000	69.6	164.4	24,000	71.0	162.6	19,400
140	30	80	64.3	160.5	24,000	65.9	159.8	22,500	67.3	157.9	18,300
140	30	90	60.5	155.1	24,000	62.1	154.3	22,500	63.5	152.3	17,200
140	30	100	56.6	148.7	23,900	58.1	147.9	21,200	59.4	145.9	16,300
140	30	110	52.4	141.3	20,800	53.9	140.5	19,700	55.2	138.3	15,400
140	30	120	48.0	132.7	18,200	49.5	131.8	18,400	50.7	129.5	14,700
140	30	130	43.3	122.6	16,100	44.8	121.7	16,200			
140	30	140	38.1	110.6	14,200	39.5	109.5	14,300			
140	30	150	32.2	95.9	12,600						
140	45	39.3	80.0	189.9	24,000						
140	45	40	79.8	189.8	24,000						
140	45	50	76.6	187.4	24,000	78.9	186.2	21,500			
140	45	60	73.5	184.4	24,000	75.7	183.2	19,100	77.9	180.7	13,300
140	45	70	70.2	180.8	22,500	72.5	179.6	17,200	74.6	177.0	12,300
140	45	80	66.9	176.5	21,300	69.1	175.4	15,700	71.2	172.7	11,500
140	45	90	63.5	171.6	19,000	65.7	170.4	14,400	67.7	167.6	10,800
140	45	100	60.0	165.8	17,200	62.2	164.6	13,300	64.1	161.8	10,200
140	45	110	56.3	159.2	15,700	58.5	158.0	12,400	60.4	155.0	9,600
140	45	120	52.5	151.7	14,400	54.6	150.4	11,700	56.4	147.3	9,200
140	45	130	48.4	143.0	13,400	50.5	141.6	11,000	52.3	138.3	8,800
140	45	140	44.1	132.9	12,500	46.2	131.5	10,400	47.8	128.0	8,500
140	45	150	39.4	121.1	11,700	41.4	119.6	9,900			
140	45	160	34.1	107.1	11,000						
140	45	170	28.0	89.6	10,400						
140	60	43.18	80.0	204.4	24,000						
140	60	50	78.0	202.9	22,500						
140	60	60	75.1	200.1	21,000	77.9	198.8	14,400			
140	60	70	72.1	196.8	18,200	74.9	195.5	13,000	77.6	192.3	9,100
140	60	80	69.1	192.9	16,100	71.9	191.6	11,800	74.5	188.3	8,500
140	60	90	66.0	188.4	14,300	68.7	187.0	10,800	71.3	183.7	7,900
140	60	100	62.8	183.2	13,000	65.5	181.8	9,900	68.0	178.4	7,400
140	60	110	59.5	177.3	11,800	62.2	175.9	9,200	64.7	172.3	7,000
140	60	120	56.1	170.5	10,800	58.8	169.1	8,600	61.2	165.4	6,700

General Use Only. Refer to the Tubular Jib Notes for Open Throat Boom before operating the machine.

Boom Length (ft)	Jib Length (ft)	Jib Load Radius (ft)	Jib Angle to Boom								
			5 Degrees			15 Degrees			25 Degrees		
			Boom Angle (deg)	Jib Pt Height (ft)	Jib Capacity ABC + A (lbs)	Boom Angle (deg)	Jib Pt Height (ft)	Jib Capacity ABC + A (lbs)	Boom Angle (deg)	Jib Pt Height (ft)	Jib Capacity ABC + A (lbs)
140	60	130	52.5	162.9	10,000	55.2	161.4	8,100	57.5	157.5	6,400
140	60	140	48.8	154.1	9,300	51.4	152.6	7,700	53.6	148.5	6,100
140	60	150	44.8	144.2	8,700	47.4	142.5	7,300	49.5	138.2	5,900
140	60	160	40.5	132.7	8,200	43.0	130.9	6,900			
140	60	170	35.7	119.1	7,700	38.1	117.1	6,600			
140	60	180	30.3	102.8	7,300						
140	75	47.06	80.0	219.3	19,500						
140	75	50	79.2	218.6	19,300						
140	75	60	76.5	216.2	17,900	79.8	214.8	12,100			
140	75	70	73.7	213.2	15,400	77.0	211.8	10,800			
140	75	80	70.9	209.6	13,500	74.2	208.3	9,700	77.3	204.7	6,800
140	75	90	68.1	205.5	12,000	71.4	204.1	8,800	74.4	200.5	6,300
140	75	100	65.2	200.8	10,800	68.4	199.4	8,100	71.4	195.7	5,900
140	75	110	62.2	195.5	9,700	65.4	194.1	7,500	68.3	190.2	5,500
140	75	120	59.1	189.4	8,900	62.3	188.0	6,900	65.2	183.9	5,200
140	75	130	55.9	182.6	8,200	59.1	181.1	6,500	61.9	176.9	4,900
140	75	140	52.6	174.9	7,600	55.7	173.4	6,100	58.4	169.0	4,700
140	75	150	49.1	166.3	7,000	52.2	164.6	5,700	54.8	160.0	4,400
140	75	160	45.4	156.4	6,600	48.4	154.7	5,400	51.0	149.7	4,300
140	75	170	41.4	145.2	6,200	44.4	143.3	5,100	46.8	137.9	4,100
140	75	180	37.1	132.2	5,800	40.0	130.0	4,900			
140	75	190	32.2	116.7	5,500	35.0	114.2	4,700			
140	75	200	26.5	97.6	5,200						
150	30	37.15	80.0	185.6	24,000						
150	30	40	79.1	185.0	24,000						
150	30	50	75.9	182.6	24,000	77.4	181.9	24,000	78.9	180.1	22,500
150	30	60	72.6	179.6	24,000	74.1	178.9	24,000	75.6	177.1	21,000
150	30	70	69.2	176.0	24,000	70.8	175.2	24,000	72.2	173.4	19,700
150	30	80	65.8	171.7	24,000	67.3	170.9	22,900	68.7	169.0	18,600
150	30	90	62.3	166.6	24,000	63.8	165.8	22,500	65.1	163.8	17,700
150	30	100	58.6	160.7	23,600	60.1	159.9	22,100	61.4	157.9	16,700
150	30	110	54.8	153.9	20,600	56.3	153.1	20,500	57.5	151.0	15,800
150	30	120	50.8	146.1	17,900	52.3	145.2	18,200	53.4	143.0	15,100
150	30	130	46.6	137.0	15,800	48.0	136.1	16,000	49.1	133.7	14,500
150	30	140	42.0	126.4	13,900	43.4	125.4	14,100			
150	30	150	37.0	113.9	12,400	38.3	112.8	12,500			
150	30	160	31.3	98.7	11,000						

HC-238H II - w/ 62" x 70" Tube Boom, w/ 24" x 32" Tube Jib, w/ ABC + A Cwt

General Use Only. Refer to the Tubular Jib Notes for Open Throat Boom before operating the machine.

Boom Length (ft)	Jib Length (ft)	Jib Load Radius (ft)	Jib Angle to Boom								
			5 Degrees			15 Degrees			25 Degrees		
			Boom Angle (deg)	Jib Pt Height (ft)	Jib Capacity ABC + A (lbs)	Boom Angle (deg)	Jib Pt Height (ft)	Jib Capacity ABC + A (lbs)	Boom Angle (deg)	Jib Pt Height (ft)	Jib Capacity ABC + A (lbs)
150	45	41.04	80.0	199.8	24,000						
150	45	50	77.3	197.7	24,000	79.5	196.5	22,000			
150	45	60	74.3	194.9	24,000	76.5	193.7	19,600	78.5	191.1	13,500
150	45	70	71.3	191.5	22,500	73.4	190.3	17,700	75.4	187.7	12,500
150	45	80	68.1	187.5	22,200	70.3	186.3	16,200	72.2	183.6	11,700
150	45	90	64.9	182.8	19,900	67.0	181.6	14,900	69.0	178.9	11,000
150	45	100	61.6	177.4	18,000	63.7	176.3	13,800	65.6	173.4	10,400
150	45	110	58.2	171.3	16,400	60.3	170.1	12,800	62.1	167.1	9,900
150	45	120	54.7	164.3	15,100	56.8	163.1	12,100	58.5	160.0	9,400
150	45	130	51.0	156.3	14,000	53.0	155.1	11,400	54.7	151.8	9,000
150	45	140	47.1	147.2	13,100	49.1	145.9	10,800	50.7	142.5	8,700
150	45	150	42.9	136.7	12,200	44.8	135.3	10,300			
150	45	160	38.3	124.5	11,300	40.2	122.9	9,800			
150	45	170	33.2	110.0	10,100						
150	45	180	27.2	91.9	9,000						
150	60	44.92	80.0	214.3	24,000						
150	60	50	78.6	213.1	22,400						
150	60	60	75.8	210.5	21,800	78.5	209.2	14,700			
150	60	70	73.0	207.4	18,900	75.7	206.0	13,300	78.2	202.8	9,300
150	60	80	70.1	203.7	16,700	72.8	202.3	12,100	75.3	199.1	8,600
150	60	90	67.2	199.4	15,000	69.8	198.1	11,100	72.3	194.7	8,100
150	60	100	64.2	194.5	13,500	66.8	193.2	10,300	69.2	189.7	7,600
150	60	110	61.1	189.0	12,300	63.7	187.6	9,500	66.1	184.0	7,200
150	60	120	57.9	182.7	11,300	60.5	181.2	8,900	62.8	177.6	6,800
150	60	130	54.6	175.6	10,500	57.2	174.1	8,400	59.4	170.3	6,500
150	60	140	51.2	167.5	9,700	53.7	166.0	7,900	55.8	162.0	6,200
150	60	150	47.5	158.4	9,100	50.0	156.8	7,500	52.1	152.6	6,000
150	60	160	43.6	148.1	8,600	46.1	146.3	7,100	48.0	141.8	5,800
150	60	170	39.4	136.1	8,100	41.8	134.3	6,800			
150	60	180	34.8	122.2	7,700	37.1	120.1	6,600			
150	60	190	29.5	105.3	7,300						
150	75	48.8	80.0	229.1	19,300						
150	75	50	79.7	228.9	19,300						
150	75	60	77.1	226.5	18,500						
150	75	70	74.5	223.6	16,000	77.6	222.2	11,000			
150	75	80	71.8	220.3	14,000	75.0	218.9	10,000	77.9	215.3	6,900

General Use Only. Refer to the Tubular Jib Notes for Open Throat Boom before operating the machine.

Boom Length (ft)	Jib Length (ft)	Jib Load Radius (ft)	Jib Angle to Boom								
			5 Degrees			15 Degrees			25 Degrees		
			Boom Angle (deg)	Jib Pt Height (ft)	Jib Capacity ABC + A (lbs)	Boom Angle (deg)	Jib Pt Height (ft)	Jib Capacity ABC + A (lbs)	Boom Angle (deg)	Jib Pt Height (ft)	Jib Capacity ABC + A (lbs)
150	75	90	69.1	216.4	12,500	72.2	215.0	9,100	75.2	211.3	6,400
150	75	100	66.3	212.0	11,200	69.5	210.5	8,300	72.3	206.7	6,000
150	75	110	63.5	206.9	10,200	66.6	205.5	7,700	69.4	201.5	5,600
150	75	120	60.6	201.2	9,300	63.7	199.7	7,200	66.4	195.7	5,300
150	75	130	57.6	194.8	8,500	60.7	193.3	6,700	63.4	189.1	5,000
150	75	140	54.5	187.7	7,900	57.5	186.1	6,300	60.2	181.7	4,800
150	75	150	51.3	179.6	7,300	54.2	178.0	5,900	56.8	173.4	4,600
150	75	160	47.9	170.6	6,900	50.8	168.9	5,600	53.3	164.0	4,400
150	75	170	44.3	160.4	6,400	47.1	158.5	5,300	49.5	153.4	4,200
150	75	180	40.4	148.7	6,000	43.2	146.7	5,100	45.5	141.1	4,000
150	75	190	36.2	135.3	5,700	38.9	133.0	4,800			
150	75	200	31.4	119.4	5,400						
150	75	210	25.9	99.7	5,200						
160	30	38.89	80.0	195.5	24,000						
160	30	40	79.7	195.2	24,000						
160	30	50	76.6	193.0	24,000	78.1	192.2	24,000	79.5	190.5	22,500
160	30	60	73.5	190.1	24,000	75.0	189.4	24,000	76.3	187.6	21,300
160	30	70	70.4	186.7	24,000	71.8	185.9	24,000	73.1	184.1	20,000
160	30	80	67.1	182.6	24,000	68.6	181.9	23,600	69.9	180.0	19,000
160	30	90	63.8	177.9	24,000	65.3	177.1	22,500	66.5	175.2	18,000
160	30	100	60.4	172.4	23,300	61.9	171.6	22,500	63.1	169.6	17,100
160	30	110	56.9	166.1	20,300	58.3	165.3	20,600	59.5	163.2	16,200
160	30	120	53.3	158.9	17,700	54.6	158.0	17,900	55.8	155.9	15,500
160	30	130	49.4	150.7	15,500	50.7	149.8	15,700	51.8	147.4	14,900
160	30	140	45.3	141.2	13,600	46.6	140.2	13,800	47.6	137.7	14,000
160	30	150	40.8	130.1	12,100	42.1	129.1	12,200			
160	30	160	36.0	117.2	10,700	37.2	116.0	10,800			
160	30	170	30.4	101.4	9,500						
160	45	42.77	80.0	209.6	24,000						
160	45	50	78.0	208.0	24,000						
160	45	60	75.1	205.3	24,000	77.2	204.1	20,100	79.1	201.5	13,700
160	45	70	72.2	202.1	23,000	74.3	200.9	18,200	76.2	198.3	12,700
160	45	80	69.2	198.3	22,500	71.3	197.1	16,600	73.2	194.4	11,900
160	45	90	66.2	193.9	20,700	68.2	192.7	15,300	70.1	189.9	11,200
160	45	100	63.1	188.9	18,800	65.1	187.7	14,200	66.9	184.8	10,600
160	45	110	60.0	183.1	17,200	61.9	181.9	13,200	63.7	179.0	10,100
160	45	120	56.7	176.6	15,800	58.6	175.4	12,400	60.3	172.3	9,600

HC-238H II - w/ 62" x 70" Tube Boom, w/ 24" x 32" Tube Jib, w/ ABC + A Cwt

General Use Only. Refer to the Tubular Jib Notes for Open Throat Boom before operating the machine.

Boom Length (ft)	Jib Length (ft)	Jib Load Radius (ft)	Jib Angle to Boom								
			5 Degrees			15 Degrees			25 Degrees		
			Boom Angle (deg)	Jib Pt Height (ft)	Jib Capacity ABC + A (lbs)	Boom Angle (deg)	Jib Pt Height (ft)	Jib Capacity ABC + A (lbs)	Boom Angle (deg)	Jib Pt Height (ft)	Jib Capacity ABC + A (lbs)
160	45	130	53.2	169.2	14,600	55.2	168.0	11,700	56.8	164.8	9,200
160	45	140	49.7	160.9	13,600	51.5	159.6	11,100	53.1	156.2	8,900
160	45	150	45.9	151.4	12,400	47.7	150.0	10,600	49.2	146.5	8,600
160	45	160	41.8	140.5	11,000	43.6	139.0	10,100			
160	45	170	37.3	127.8	9,800	39.1	126.2	9,700			
160	45	180	32.3	112.8	8,800						
160	60	46.66	80.0	224.1	24,000						
160	60	50	79.1	223.4	23,100						
160	60	60	76.5	220.9	22,400	79.1	219.5	15,000			
160	60	70	73.8	217.9	19,600	76.4	216.5	13,600	78.8	213.3	9,400
160	60	80	71.0	214.4	17,400	73.6	213.0	12,400	76.0	209.7	8,800
160	60	90	68.3	210.4	15,500	70.8	209.0	11,400	73.2	205.6	8,200
160	60	100	65.4	205.8	14,100	68.0	204.3	10,500	70.3	200.9	7,700
160	60	110	62.5	200.5	12,800	65.0	199.1	9,800	67.3	195.5	7,300
160	60	120	59.5	194.6	11,800	62.0	193.1	9,200	64.2	189.5	6,900
160	60	130	56.5	187.9	10,900	58.9	186.5	8,600	61.0	182.7	6,600
160	60	140	53.2	180.5	10,200	55.7	178.9	8,100	57.7	175.0	6,300
160	60	150	49.9	172.1	9,500	52.3	170.5	7,700	54.3	166.4	6,100
160	60	160	46.3	162.6	8,900	48.7	160.9	7,400	50.6	156.6	5,900
160	60	170	42.6	151.9	8,400	44.9	150.1	7,000	46.7	145.4	5,700
160	60	180	38.5	139.5	8,000	40.7	137.6	6,800			
160	60	190	34.0	125.1	7,600						
160	60	200	28.8	107.8	7,200						
160	75	50.54	80.0	239.0	19,100						
160	75	60	77.7	236.8	18,500						
160	75	70	75.2	234.1	16,600	78.2	232.7	11,200			
160	75	80	72.6	230.9	14,500	75.6	229.5	10,200	78.5	225.8	7,000
160	75	90	70.0	227.2	13,000	73.0	225.7	9,300	75.8	222.0	6,500
160	75	100	67.4	223.0	11,700	70.4	221.5	8,600	73.2	217.7	6,100
160	75	110	64.7	218.2	10,600	67.7	216.7	7,900	70.4	212.8	5,700
160	75	120	62.0	212.8	9,700	64.9	211.3	7,400	67.6	207.2	5,400
160	75	130	59.2	206.8	8,900	62.1	205.2	6,900	64.7	201.1	5,100
160	75	140	56.3	200.1	8,200	59.1	198.5	6,500	61.7	194.1	4,900
160	75	150	53.2	192.6	7,700	56.1	190.9	6,100	58.6	186.4	4,700
160	75	160	50.1	184.2	7,200	52.9	182.5	5,800	55.3	177.7	4,500
160	75	170	46.8	174.8	6,700	49.5	173.0	5,500	51.9	168.0	4,300
160	75	180	43.3	164.2	6,300	46.0	162.3	5,200	48.2	156.9	4,100

General Use Only. Refer to the Tubular Jib Notes for Open Throat Boom before operating the machine.

Boom Length (ft)	Jib Length (ft)	Jib Load Radius (ft)	Jib Angle to Boom								
			5 Degrees			15 Degrees			25 Degrees		
			Boom Angle (deg)	Jib Pt Height (ft)	Jib Capacity ABC + A (lbs)	Boom Angle (deg)	Jib Pt Height (ft)	Jib Capacity ABC + A (lbs)	Boom Angle (deg)	Jib Pt Height (ft)	Jib Capacity ABC + A (lbs)
160	75	190	39.5	152.2	6,000	42.1	150.1	5,000			
160	75	200	35.4	138.4	5,700	37.9	136.0	4,800			
160	75	210	30.7	122.0	5,400						
160	75	220	25.3	101.9	5,200						
170	30	40.63	80.0	205.3	24,000						
170	30	50	77.3	203.3	24,000	78.7	202.5	24,000			
170	30	60	74.3	200.6	24,000	75.8	199.8	24,000	77.1	198.0	21,500
170	30	70	71.4	197.3	24,000	72.8	196.6	24,000	74.0	194.7	20,300
170	30	80	68.3	193.5	24,000	69.7	192.7	24,000	71.0	190.8	19,300
170	30	90	65.2	189.0	24,000	66.6	188.3	22,500	67.8	186.3	18,300
170	30	100	62.1	183.9	23,000	63.4	183.1	22,500	64.6	181.1	17,500
170	30	110	58.8	178.0	20,000	60.1	177.2	20,300	61.2	175.2	16,600
170	30	120	55.4	171.3	17,400	56.7	170.5	17,700	57.8	168.4	15,900
170	30	130	51.8	163.7	15,200	53.1	162.9	15,400	54.2	160.6	15,200
170	30	140	48.1	155.1	13,400	49.3	154.2	13,600	50.3	151.8	13,700
170	30	150	44.1	145.2	11,800	45.3	144.2	12,000	46.3	141.7	12,100
170	30	160	39.8	133.7	10,400	41.0	132.6	10,600			
170	30	170	35.0	120.3	9,200	36.2	119.1	9,300			
170	30	180	29.6	104.0	8,200						
170	45	44.51	80.0	219.5	24,000						
170	45	50	78.5	218.3	24,000						
170	45	60	75.8	215.7	24,000	77.8	214.5	20,500	79.6	211.9	13,900
170	45	70	73.0	212.7	23,800	75.0	211.5	18,600	76.8	208.8	12,900
170	45	80	70.2	209.1	22,500	72.2	207.9	17,000	74.0	205.1	12,100
170	45	90	67.4	204.9	21,600	69.3	203.7	15,700	71.1	200.9	11,400
170	45	100	64.5	200.2	19,600	66.4	198.9	14,600	68.1	196.1	10,800
170	45	110	61.5	194.8	17,900	63.4	193.5	13,600	65.1	190.6	10,300
170	45	120	58.4	188.7	16,500	60.3	187.4	12,800	61.9	184.4	9,800
170	45	130	55.2	181.8	15,300	57.1	180.5	12,100	58.7	177.4	9,400
170	45	140	51.9	174.0	13,700	53.7	172.7	11,500	55.3	169.5	9,100
170	45	150	48.4	165.3	12,100	50.2	163.9	10,900	51.7	160.5	8,700
170	45	160	44.7	155.4	10,700	46.5	154.0	10,400	47.9	150.4	8,500
170	45	170	40.7	144.1	9,500	42.4	142.6	9,700			
170	45	180	36.4	131.0	8,500	38.1	129.3	8,600			
170	45	190	31.5	115.5	7,500						
170	60	48.39	80.0	234.0	24,000						

HC-238H II - w/ 62" x 70" Tube Boom, w/ 24" x 32" Tube Jib, w/ ABC + A Cwt

General Use Only. Refer to the Tubular Jib Notes for Open Throat Boom before operating the machine.

Boom Length (ft)	Jib Length (ft)	Jib Load Radius (ft)	Jib Angle to Boom								
			5 Degrees			15 Degrees			25 Degrees		
			Boom Angle (deg)	Jib Pt Height (ft)	Jib Capacity ABC + A (lbs)	Boom Angle (deg)	Jib Pt Height (ft)	Jib Capacity ABC + A (lbs)	Boom Angle (deg)	Jib Pt Height (ft)	Jib Capacity ABC + A (lbs)
170	60	50	79.6	233.6	23,700						
170	60	60	77.1	231.3	22,400	79.5	229.8	15,300			
170	60	70	74.5	228.4	20,300	77.0	227.0	13,900	79.3	223.7	9,500
170	60	80	71.9	225.1	18,000	74.4	223.7	12,700	76.6	220.3	8,900
170	60	90	69.3	221.2	16,100	71.7	219.8	11,700	73.9	216.4	8,300
170	60	100	66.6	216.8	14,600	69.0	215.4	10,800	71.2	211.9	7,900
170	60	110	63.8	211.9	13,300	66.2	210.4	10,100	68.4	206.9	7,500
170	60	120	61.0	206.3	12,300	63.4	204.8	9,400	65.5	201.2	7,100
170	60	130	58.1	200.0	11,400	60.4	198.6	8,900	62.5	194.8	6,800
170	60	140	55.1	193.1	10,600	57.4	191.5	8,400	59.4	187.6	6,500
170	60	150	52.0	185.2	9,900	54.3	183.7	8,000	56.2	179.6	6,200
170	60	160	48.7	176.5	9,300	51.0	174.9	7,600	52.9	170.6	6,000
170	60	170	45.3	166.7	8,700	47.5	164.9	7,200	49.3	160.4	5,800
170	60	180	41.6	155.6	8,300	43.7	153.7	6,900			
170	60	190	37.6	142.8	7,800	39.7	140.8	6,700			
170	60	200	33.2	128.0	6,900						
170	60	210	28.1	110.2	6,100						
170	75	52.27	80.0	248.8	18,900						
170	75	60	78.2	247.1	18,400						
170	75	70	75.8	244.5	17,100	78.7	243.0	11,500			
170	75	80	73.3	241.4	15,100	76.2	240.0	10,400	79.0	236.3	7,100
170	75	90	70.9	237.9	13,400	73.8	236.4	9,500	76.5	232.7	6,600
170	75	100	68.4	233.9	12,100	71.2	232.4	8,800	73.9	228.5	6,200
170	75	110	65.8	229.3	11,000	68.7	227.8	8,100	71.3	223.9	5,800
170	75	120	63.2	224.2	10,100	66.1	222.7	7,600	68.6	218.6	5,500
170	75	130	60.6	218.5	9,300	63.4	217.0	7,100	65.9	212.8	5,200
170	75	140	57.8	212.2	8,600	60.6	210.6	6,700	63.1	206.3	5,000
170	75	150	55.0	205.2	8,000	57.7	203.5	6,300	60.2	199.0	4,700
170	75	160	52.0	197.3	7,400	54.8	195.6	5,900	57.1	191.0	4,500
170	75	170	49.0	188.6	7,000	51.6	186.8	5,600	53.9	181.9	4,400
170	75	180	45.7	178.9	6,600	48.4	177.0	5,400	50.6	171.8	4,200
170	75	190	42.3	168.0	6,200	44.9	166.0	5,100	47.0	160.4	4,100
170	75	200	38.6	155.6	5,900	41.1	153.4	4,900			
170	75	210	34.6	141.3	5,600	37.0	138.9	4,700			
170	75	220	30.0	124.6	5,300						
180	30	42.36	80.0	215.2	24,000						
180	30	50	77.9	213.6	24,000	79.2	212.8	24,000			

General Use Only. Refer to the Tubular Jib Notes for Open Throat Boom before operating the machine.

Boom Length (ft)	Jib Length (ft)	Jib Load Radius (ft)	Jib Angle to Boom								
			5 Degrees			15 Degrees			25 Degrees		
			Boom Angle (deg)	Jib Pt Height (ft)	Jib Capacity ABC + A (lbs)	Boom Angle (deg)	Jib Pt Height (ft)	Jib Capacity ABC + A (lbs)	Boom Angle (deg)	Jib Pt Height (ft)	Jib Capacity ABC + A (lbs)
180	30	60	75.1	211.0	24,000	76.4	210.2	24,000	77.7	208.4	21,800
180	30	70	72.3	207.9	24,000	73.6	207.1	24,000	74.8	205.3	20,600
180	30	80	69.4	204.3	24,000	70.7	203.5	24,000	71.9	201.6	19,500
180	30	90	66.5	200.1	24,000	67.8	199.3	23,100	69.0	197.4	18,600
180	30	100	63.5	195.2	22,700	64.8	194.4	22,500	65.9	192.5	17,800
180	30	110	60.4	189.7	19,700	61.7	188.9	20,100	62.8	186.9	17,000
180	30	120	57.2	183.5	17,100	58.5	182.6	17,400	59.6	180.5	16,200
180	30	130	53.9	176.4	14,900	55.2	175.6	15,200	56.2	173.4	15,400
180	30	140	50.5	168.4	13,100	51.7	167.5	13,300	52.7	165.2	13,500
180	30	150	46.8	159.4	11,500	48.0	158.4	11,700	49.0	156.0	11,800
180	30	160	43.0	149.1	10,100	44.1	148.1	10,300			
180	30	170	38.8	137.2	8,900	39.9	136.1	9,100			
180	30	180	34.1	123.3	7,900						
180	30	190	28.9	106.5	6,900						
180	45	46.25	80.0	229.3	24,000						
180	45	50	79.0	228.5	24,000						
180	45	60	76.4	226.1	24,000	78.3	224.9	20,900			
180	45	70	73.8	223.2	24,000	75.7	222.0	19,000	77.4	219.3	13,100
180	45	80	71.2	219.8	22,500	73.0	218.5	17,500	74.7	215.8	12,300
180	45	90	68.5	215.8	22,400	70.3	214.6	16,100	72.0	211.8	11,600
180	45	100	65.7	211.3	20,300	67.5	210.1	15,000	69.2	207.2	11,000
180	45	110	62.9	206.2	18,600	64.7	205.0	14,000	66.3	202.0	10,500
180	45	120	60.0	200.5	17,100	61.8	199.2	13,200	63.3	196.2	10,000
180	45	130	57.0	194.0	15,200	58.8	192.7	12,400	60.3	189.6	9,600
180	45	140	53.9	186.8	13,400	55.6	185.5	11,800	57.1	182.3	9,200
180	45	150	50.6	178.7	11,800	52.4	177.4	11,200	53.8	174.0	8,900
180	45	160	47.2	169.6	10,400	48.9	168.2	10,700	50.3	164.7	8,600
180	45	170	43.6	159.4	9,200	45.3	157.9	9,400			
180	45	180	39.8	147.7	8,200	41.4	146.1	8,400			
180	45	190	35.5	134.2	7,200	37.1	132.4	7,400			
180	45	200	30.8	118.2	6,400						
180	60	50.13	80.0	243.8	24,000						
180	60	60	77.6	241.6	22,300						
180	60	70	75.2	238.9	21,000	77.5	237.4	14,100	79.8	234.1	9,600
180	60	80	72.7	235.7	18,600	75.0	234.2	12,900	77.2	230.9	9,000
180	60	90	70.2	232.0	16,700	72.5	230.6	11,900	74.7	227.2	8,500
180	60	100	67.6	227.8	15,100	69.9	226.4	11,100	72.1	222.9	8,000

HC-238H II - w/ 62" x 70" Tube Boom, w/ 24" x 32" Tube Jib, w/ ABC + A Cwt

General Use Only. Refer to the Tubular Jib Notes for Open Throat Boom before operating the machine.

Boom Length (ft)	Jib Length (ft)	Jib Load Radius (ft)	Jib Angle to Boom								
			5 Degrees			15 Degrees			25 Degrees		
			Boom Angle (deg)	Jib Pt Height (ft)	Jib Capacity ABC + A (lbs)	Boom Angle (deg)	Jib Pt Height (ft)	Jib Capacity ABC + A (lbs)	Boom Angle (deg)	Jib Pt Height (ft)	Jib Capacity ABC + A (lbs)
180	60	110	65.0	223.1	13,800	67.3	221.7	10,300	69.4	218.1	7,600
180	60	120	62.3	217.8	12,700	64.6	216.3	9,700	66.7	212.7	7,200
180	60	130	59.6	211.9	11,800	61.8	210.4	9,100	63.9	206.7	6,900
180	60	140	56.8	205.3	11,000	59.0	203.8	8,600	61.0	199.9	6,600
180	60	150	53.8	198.0	10,300	56.0	196.5	8,200	58.0	192.4	6,300
180	60	160	50.8	189.9	9,600	53.0	188.3	7,800	54.8	184.1	6,100
180	60	170	47.6	180.8	9,100	49.8	179.1	7,400	51.5	174.7	5,900
180	60	180	44.2	170.6	8,400	46.3	168.8	7,100	48.0	164.2	5,700
180	60	190	40.6	159.2	7,500	42.7	157.2	6,900			
180	60	200	36.8	146.0	6,600	38.8	143.9	6,600			
180	60	210	32.4	130.8	5,800						
180	60	220	27.5	112.5	5,200						
180	75	54.01	80.0	258.7	18,700						
180	75	60	78.6	257.4	18,300						
180	75	70	76.3	254.9	17,700	79.1	253.4	11,700			
180	75	80	74.0	251.9	15,600	76.8	250.5	10,600	79.4	246.7	7,200
180	75	90	71.7	248.6	13,900	74.4	247.1	9,700	77.0	243.3	6,700
180	75	100	69.3	244.7	12,500	72.0	243.2	9,000	74.6	239.3	6,300
180	75	110	66.8	240.4	11,400	69.6	238.9	8,300	72.1	234.9	5,900
180	75	120	64.4	235.5	10,400	67.1	234.0	7,800	69.6	229.9	5,600
180	75	130	61.8	230.1	9,600	64.5	228.6	7,300	67.0	224.4	5,300
180	75	140	59.2	224.1	8,900	61.9	222.5	6,800	64.3	218.2	5,100
180	75	150	56.6	217.5	8,300	59.2	215.8	6,400	61.6	211.4	4,800
180	75	160	53.8	210.1	7,700	56.4	208.4	6,100	58.7	203.8	4,600
180	75	170	50.9	202.0	7,300	53.5	200.2	5,800	55.7	195.4	4,500
180	75	180	47.9	193.0	6,800	50.5	191.1	5,500	52.6	186.1	4,300
180	75	190	44.8	182.9	6,400	47.3	180.9	5,300	49.4	175.6	4,100
180	75	200	41.4	171.6	6,100	43.9	169.5	5,100	45.8	163.8	4,000
180	75	210	37.8	158.9	5,800	40.2	156.6	4,900			
180	75	220	33.9	144.3	5,300	36.2	141.7	4,700			
180	75	230	29.4	127.1	4,700						
190	30	44.1	80.0	225.0	24,000						
190	30	50	78.4	223.8	24,000	79.7	223.0	24,000			
190	30	60	75.8	221.4	24,000	77.1	220.6	24,000	78.3	218.8	22,000
190	30	70	73.1	218.4	24,000	74.4	217.7	24,000	75.5	215.8	20,800
190	30	80	70.4	215.0	24,000	71.6	214.2	24,000	72.8	212.3	19,800
190	30	90	67.6	211.0	24,000	68.9	210.2	23,700	70.0	208.3	18,900

General Use Only. Refer to the Tubular Jib Notes for Open Throat Boom before operating the machine.

Boom Length (ft)	Jib Length (ft)	Jib Load Radius (ft)	Jib Angle to Boom								
			5 Degrees			15 Degrees			25 Degrees		
			Boom Angle (deg)	Jib Pt Height (ft)	Jib Capacity ABC + A (lbs)	Boom Angle (deg)	Jib Pt Height (ft)	Jib Capacity ABC + A (lbs)	Boom Angle (deg)	Jib Pt Height (ft)	Jib Capacity ABC + A (lbs)
190	30	100	64.8	206.4	22,400	66.0	205.6	22,500	67.1	203.7	18,100
190	30	110	61.9	201.2	19,400	63.1	200.4	19,800	64.2	198.4	17,300
190	30	120	58.9	195.4	16,800	60.1	194.5	17,100	61.1	192.4	16,600
190	30	130	55.8	188.8	14,600	57.0	187.9	14,900	58.0	185.8	15,100
190	30	140	52.6	181.4	12,800	53.8	180.5	13,000	54.7	178.2	13,200
190	30	150	49.2	173.0	11,200	50.4	172.1	11,400	51.3	169.7	11,600
190	30	160	45.7	163.6	9,800	46.8	162.6	10,000	47.7	160.1	10,100
190	30	170	41.9	152.9	8,600	43.0	151.8	8,800			
190	30	180	37.8	140.6	7,600	38.9	139.5	7,700			
190	30	190	33.3	126.3	6,600						
190	30	200	28.2	109.0	5,800						
190	45	47.98	80.0	239.1	24,000						
190	45	50	79.5	238.7	24,000						
190	45	60	77.0	236.4	24,000	78.8	235.2	21,300			
190	45	70	74.5	233.6	24,000	76.3	232.4	19,400	78.0	229.7	13,300
190	45	80	72.0	230.4	22,700	73.8	229.2	17,900	75.4	226.4	12,500
190	45	90	69.4	226.6	22,400	71.2	225.4	16,500	72.8	222.6	11,800
190	45	100	66.8	222.3	21,100	68.5	221.1	15,400	70.1	218.3	11,200
190	45	110	64.1	217.5	19,300	65.9	216.3	14,400	67.4	213.3	10,600
190	45	120	61.4	212.1	17,200	63.1	210.8	13,500	64.6	207.8	10,200
190	45	130	58.5	206.0	15,000	60.3	204.7	12,800	61.8	201.7	9,800
190	45	140	55.6	199.2	13,100	57.3	197.9	12,100	58.8	194.8	9,400
190	45	150	52.6	191.7	11,500	54.3	190.3	11,500	55.7	187.1	9,100
190	45	160	49.5	183.2	10,100	51.1	181.9	10,400	52.5	178.4	8,800
190	45	170	46.2	173.8	8,900	47.8	172.4	9,200	49.1	168.8	8,500
190	45	180	42.6	163.2	7,900	44.2	161.7	8,100			
190	45	190	38.9	151.1	6,900	40.4	149.5	7,100			
190	45	200	34.7	137.2	6,100						
190	45	210	30.1	120.8	5,300						
190	60	51.87	80.0	253.7	23,600						
190	60	60	78.1	251.9	22,000						
190	60	70	75.8	249.3	21,400	78.0	247.8	14,400			
190	60	80	73.4	246.2	19,200	75.7	244.8	13,200	77.8	241.4	9,100
190	60	90	71.0	242.7	17,300	73.2	241.3	12,200	75.3	237.8	8,600
190	60	100	68.5	238.7	15,700	70.8	237.3	11,300	72.8	233.8	8,100
190	60	110	66.1	234.2	14,300	68.3	232.8	10,600	70.3	229.2	7,700
190	60	120	63.5	229.2	13,200	65.7	227.7	9,900	67.7	224.1	7,300

HC-238H II - w/ 62" x 70" Tube Boom, w/ 24" x 32" Tube Jib, w/ ABC + A Cwt

General Use Only. Refer to the Tubular Jib Notes for Open Throat Boom before operating the machine.

General Use Only. Refer to the Tubular Jib Notes for Open Throat Boom before operating the machine.

Boom Length (ft)	Jib Length (ft)	Jib Load Radius (ft)	Jib Angle to Boom								
			5 Degrees			15 Degrees			25 Degrees		
			Boom Angle (deg)	Jib Pt Height (ft)	Jib Capacity ABC + A (lbs)	Boom Angle (deg)	Jib Pt Height (ft)	Jib Capacity ABC + A (lbs)	Boom Angle (deg)	Jib Pt Height (ft)	Jib Capacity ABC + A (lbs)
190	60	130	60.9	223.6	12,200	63.1	222.1	9,300	65.0	218.4	7,000
190	60	140	58.3	217.4	11,400	60.4	215.9	8,800	62.3	212.0	6,700
190	60	150	55.5	210.5	10,600	57.6	208.9	8,400	59.5	205.0	6,500
190	60	160	52.7	202.9	10,000	54.8	201.3	8,000	56.6	197.2	6,200
190	60	170	49.7	194.4	9,200	51.8	192.8	7,600	53.5	188.5	6,000
190	60	180	46.6	185.0	8,100	48.6	183.3	7,300	50.3	178.8	5,800
190	60	190	43.3	174.5	7,200	45.3	172.7	7,000	46.9	167.9	5,700
190	60	200	39.8	162.7	6,300	41.7	160.7	6,500			
190	60	210	36.0	149.2	5,600	37.9	147.0	5,700			
190	60	220	31.8	133.5	4,900						
190	60	230	26.9	114.8	4,200						
190	75	55.75	80.0	268.5	18,400						
190	75	60	79.1	267.6	18,100						
190	75	70	76.9	265.2	17,600	79.6	263.7	11,900			
190	75	80	74.6	262.4	16,100	77.3	260.9	10,800	79.9	257.1	7,300
190	75	90	72.4	259.2	14,300	75.0	257.6	9,900	77.6	253.8	6,800
190	75	100	70.1	255.5	12,900	72.7	254.0	9,200	75.2	250.0	6,400
190	75	110	67.8	251.3	11,800	70.4	249.8	8,500	72.8	245.8	6,000
190	75	120	65.4	246.7	10,800	68.0	245.1	8,000	70.4	241.1	5,700
190	75	130	63.0	241.5	9,900	65.6	240.0	7,500	68.0	235.8	5,400
190	75	140	60.5	235.8	9,200	63.1	234.2	7,000	65.4	229.9	5,200
190	75	150	58.0	229.6	8,600	60.5	227.9	6,600	62.8	223.5	4,900
190	75	160	55.4	222.6	8,000	57.9	220.9	6,300	60.1	216.3	4,700
190	75	170	52.7	215.0	7,500	55.2	213.2	6,000	57.4	208.5	4,500
190	75	180	49.9	206.5	7,100	52.4	204.7	5,700	54.5	199.7	4,400
190	75	190	46.9	197.2	6,700	49.4	195.3	5,400	51.4	190.1	4,200
190	75	200	43.9	186.8	6,300	46.3	184.8	5,200	48.2	179.3	4,100
190	75	210	40.6	175.2	5,700	42.9	173.1	5,000			
190	75	220	37.0	162.1	5,000	39.3	159.8	4,800			
190	75	230	33.2	147.1	4,400	35.4	144.5	4,600			
190	75	240	28.8	129.5	3,800						
200	30	45.84	80.0	234.9	24,000						
200	30	50	79.0	234.0	24,000						
200	30	60	76.4	231.7	24,000	77.6	230.9	24,000	78.8	229.1	22,200
200	30	70	73.9	228.9	24,000	75.1	228.1	24,000	76.2	226.3	21,100
200	30	80	71.3	225.6	24,000	72.5	224.8	24,000	73.6	223.0	20,100
200	30	90	68.6	221.8	24,000	69.8	221.0	24,000	70.9	219.1	19,200

Boom Length (ft)	Jib Length (ft)	Jib Load Radius (ft)	Jib Angle to Boom								
			5 Degrees			15 Degrees			25 Degrees		
			Boom Angle (deg)	Jib Pt Height (ft)	Jib Capacity ABC + A (lbs)	Boom Angle (deg)	Jib Pt Height (ft)	Jib Capacity ABC + A (lbs)	Boom Angle (deg)	Jib Pt Height (ft)	Jib Capacity ABC + A (lbs)
200	30	100	65.9	217.5	22,400	67.1	216.7	22,500	68.2	214.7	18,400
200	30	110	63.2	212.6	19,200	64.4	211.8	19,500	65.4	209.8	17,600
200	30	120	60.4	207.0	16,500	61.5	206.2	16,900	62.5	204.2	16,900
200	30	130	57.5	200.8	14,300	58.6	200.0	14,600	59.6	197.9	14,900
200	30	140	54.5	193.9	12,500	55.6	193.0	12,700	56.5	190.8	13,000
200	30	150	51.3	186.1	10,900	52.5	185.2	11,100	53.4	182.9	11,300
200	30	160	48.1	177.5	9,500	49.2	176.5	9,700	50.0	174.1	9,900
200	30	170	44.6	167.7	8,300	45.7	166.7	8,500	46.5	164.1	8,600
200	30	180	40.9	156.6	7,300	42.0	155.5	7,400			
200	30	190	37.0	143.9	6,300	38.0	142.8	6,500			
200	30	200	32.6	129.2	5,500						
200	30	210	27.5	111.4	4,700						
200	45	49.72	80.0	249.0	24,000						
200	45	50	79.9	248.9	24,000						
200	45	60	77.6	246.7	24,000	79.3	245.5	21,700			
200	45	70	75.2	244.1	24,000	76.9	242.8	19,800	78.5	240.1	13,400
200	45	80	72.7	240.9	23,400	74.5	239.7	18,200	76.0	237.0	12,600
200	45	90	70.3	237.4	22,400	72.0	236.1	16,900	73.6	233.3	12,000
200	45	100	67.8	233.3	21,900	69.5	232.0	15,700	71.0	229.2	11,400
200	45	110	65.2	228.7	19,500	66.9	227.4	14,700	68.4	224.5	10,800
200	45	120	62.6	223.5	16,900	64.3	222.3	13,900	65.8	219.3	10,400
200	45	130	60.0	217.8	14,700	61.6	216.5	13,100	63.1	213.5	9,900
200	45	140	57.2	211.4	12,800	58.9	210.1	12,400	60.3	207.0	9,600
200	45	150	54.4	204.3	11,200	56.0	203.0	11,600	57.4	199.7	9,200
200	45	160	51.4	196.4	9,800	53.0	195.1	10,100	54.4	191.7	8,900
200	45	170	48.4	187.7	8,600	49.9	186.3	8,900	51.2	182.8	8,700
200	45	180	45.1	177.9	7,600	46.7	176.4	7,800	47.9	172.7	8,000
200	45	190	41.7	166.9	6,600	43.2	165.4	6,800			
200	45	200	38.0	154.5	5,800	39.5	152.8	6,000			
200	45	210	34.0	140.2	5,000						
200	45	220	29.5	123.4	4,300						
200	60	53.6	80.0	263.5	22,100						
200	60	60	78.6	262.1	21,700						
200	60	70	76.3	259.6	21,100	78.5	258.2	14,600			
200	60	80	74.0	256.7	19,800	76.2	255.2	13,500	78.3	251.8	9,200
200	60	90	71.7	253.3	17,800	73.9	251.9	12,400	75.9	248.4	8,700
200	60	100	69.4	249.5	16,200	71.6	248.1	11,600	73.5	244.6	8,200

HC-238H II - w/ 62" x 70" Tube Boom, w/ 24" x 32" Tube Jib, w/ ABC + A Cwt

General Use Only. Refer to the Tubular Jib Notes for Open Throat Boom before operating the machine.

Boom Length (ft)	Jib Length (ft)	Jib Load Radius (ft)	Jib Angle to Boom								
			5 Degrees			15 Degrees			25 Degrees		
			Boom Angle (deg)	Jib Pt Height (ft)	Jib Capacity ABC + A (lbs)	Boom Angle (deg)	Jib Pt Height (ft)	Jib Capacity ABC + A (lbs)	Boom Angle (deg)	Jib Pt Height (ft)	Jib Capacity ABC + A (lbs)
200	60	110	67.0	245.2	14,800	69.2	243.8	10,800	71.1	240.2	7,800
200	60	120	64.6	240.5	13,600	66.7	239.0	10,200	68.6	235.3	7,400
200	60	130	62.1	235.1	12,600	64.2	233.6	9,600	66.1	229.9	7,100
200	60	140	59.6	229.2	11,800	61.7	227.7	9,100	63.5	223.9	6,800
200	60	150	57.0	222.7	11,000	59.1	221.2	8,600	60.9	217.2	6,600
200	60	160	54.3	215.5	10,100	56.4	213.9	8,200	58.1	209.9	6,300
200	60	170	51.5	207.6	8,900	53.6	206.0	7,800	55.3	201.7	6,100
200	60	180	48.6	198.9	7,800	50.6	197.1	7,500	52.3	192.7	5,900
200	60	190	45.6	189.1	6,900	47.6	187.3	7,100	49.1	182.7	5,800
200	60	200	42.4	178.3	6,000	44.3	176.4	6,300			
200	60	210	39.0	166.1	5,200	40.8	164.1	5,500			
200	60	220	35.2	152.3	4,600	37.0	150.0	4,700			
200	60	230	31.1	136.2	3,900						
200	75	57.48	80.0	278.4	18,100						
200	75	60	79.5	277.8	17,900						
200	75	70	77.3	275.5	17,400						
200	75	80	75.2	272.8	16,500	77.8	271.3	11,000			
200	75	90	73.0	269.7	14,800	75.6	268.2	10,100	78.0	264.3	6,900
200	75	100	70.8	266.2	13,400	73.4	264.6	9,400	75.8	260.7	6,500
200	75	110	68.6	262.2	12,200	71.2	260.7	8,700	73.5	256.6	6,100
200	75	120	66.4	257.8	11,100	68.9	256.2	8,100	71.2	252.1	5,800
200	75	130	64.1	252.9	10,300	66.6	251.3	7,600	68.9	247.1	5,500
200	75	140	61.7	247.4	9,500	64.2	245.8	7,200	66.4	241.5	5,200
200	75	150	59.3	241.4	8,900	61.8	239.8	6,800	64.0	235.4	5,000
200	75	160	56.8	234.9	8,300	59.3	233.2	6,400	61.4	228.6	4,800
200	75	170	54.3	227.6	7,800	56.7	225.9	6,100	58.8	221.2	4,600
200	75	180	51.6	219.7	7,300	54.0	217.9	5,800	56.1	213.0	4,400
200	75	190	48.9	211.0	6,900	51.3	209.1	5,600	53.3	204.0	4,300
200	75	200	46.0	201.3	6,200	48.4	199.4	5,300	50.3	194.0	4,200
200	75	210	43.0	190.7	5,400	45.3	188.6	5,100	47.1	182.9	4,000
200	75	220	39.8	178.7	4,700	42.0	176.5	4,900			
200	75	230	36.3	165.3	4,100	38.5	162.8	4,300			
200	75	240	32.5	149.9	3,500						
200	75	250	28.3	131.9	3,000						
210	30	47.57	80.0	244.7	24,000						
210	30	50	79.4	244.2	24,000						
210	30	60	77.0	242.0	24,000	78.2	241.2	24,000	79.3	239.4	22,400

General Use Only. Refer to the Tubular Jib Notes for Open Throat Boom before operating the machine.

Boom Length (ft)	Jib Length (ft)	Jib Load Radius (ft)	Jib Angle to Boom								
			5 Degrees			15 Degrees			25 Degrees		
			Boom Angle (deg)	Jib Pt Height (ft)	Jib Capacity ABC + A (lbs)	Boom Angle (deg)	Jib Pt Height (ft)	Jib Capacity ABC + A (lbs)	Boom Angle (deg)	Jib Pt Height (ft)	Jib Capacity ABC + A (lbs)
210	30	70	74.5	239.3	24,000	75.7	238.5	24,000	76.8	236.7	21,300
210	30	80	72.1	236.2	24,000	73.2	235.4	24,000	74.3	233.5	20,300
210	30	90	69.6	232.6	24,000	70.7	231.8	24,000	71.7	229.9	19,400
210	30	100	67.0	228.5	22,100	68.1	227.6	22,300	69.2	225.7	18,600
210	30	110	64.4	223.8	18,900	65.5	223.0	19,300	66.5	221.0	17,900
210	30	120	61.7	218.5	16,200	62.8	217.7	16,600	63.8	215.7	16,900
210	30	130	59.0	212.7	14,100	60.1	211.8	14,400	61.0	209.7	14,600
210	30	140	56.1	206.2	12,200	57.2	205.3	12,500	58.2	203.1	12,700
210	30	150	53.2	198.9	10,600	54.3	198.0	10,800	55.2	195.8	11,000
210	30	160	50.2	190.8	9,200	51.2	189.9	9,400	52.1	187.5	9,600
210	30	170	47.0	181.8	8,000	48.0	180.8	8,200	48.9	178.4	8,400
210	30	180	43.6	171.7	7,000	44.7	170.6	7,100			
210	30	190	40.0	160.2	6,000	41.0	159.1	6,200			
210	30	200	36.2	147.2	5,200	37.1	146.0	5,300			
210	30	210	31.9	132.0	4,400						
210	30	220	26.9	113.8	3,800						
210	45	51.46	80.0	258.8	24,000						
210	45	60	78.1	257.0	24,000	79.7	255.8	22,100			
210	45	70	75.8	254.4	24,000	77.4	253.2	20,200	79.0	250.5	13,600
210	45	80	73.4	251.5	24,000	75.1	250.2	18,600	76.6	247.5	12,800
210	45	90	71.1	248.0	22,400	72.7	246.8	17,300	74.2	244.0	12,100
210	45	100	68.7	244.1	22,400	70.3	242.9	16,100	71.8	240.0	11,500
210	45	110	66.3	239.7	19,200	67.9	238.5	15,100	69.3	235.6	11,000
210	45	120	63.8	234.8	16,600	65.4	233.6	14,200	66.8	230.6	10,500
210	45	130	61.3	229.4	14,400	62.9	228.1	13,400	64.3	225.1	10,100
210	45	140	58.7	223.3	12,500	60.2	222.0	12,700	61.6	218.9	9,700
210	45	150	56.0	216.6	10,900	57.5	215.3	11,300	58.9	212.1	9,400
210	45	160	53.2	209.2	9,500	54.8	207.9	9,900	56.1	204.6	9,100
210	45	170	50.4	201.1	8,300	51.9	199.7	8,600	53.1	196.2	8,800
210	45	180	47.4	192.0	7,300	48.8	190.5	7,500	50.1	187.0	7,700
210	45	190	44.2	181.9	6,300	45.7	180.4	6,500			
210	45	200	40.8	170.6	5,500	42.3	169.0	5,700			
210	45	210	37.2	157.8	4,700	38.6	156.1	4,900			
210	45	220	33.3	143.1	4,000						
210	45	230	28.9	125.9	3,400						
210	60	55.34	80.0	273.4	21,600						
210	60	60	79.0	272.4	21,300						

HC-238H II - w/ 62" x 70" Tube Boom, w/ 24" x 32" Tube Jib, w/ ABC + A Cwt

General Use Only. Refer to the Tubular Jib Notes for Open Throat Boom before operating the machine.

Boom Length (ft)	Jib Length (ft)	Jib Load Radius (ft)	Jib Angle to Boom								
			5 Degrees			15 Degrees			25 Degrees		
			Boom Angle (deg)	Jib Pt Height (ft)	Jib Capacity ABC + A (lbs)	Boom Angle (deg)	Jib Pt Height (ft)	Jib Capacity ABC + A (lbs)	Boom Angle (deg)	Jib Pt Height (ft)	Jib Capacity ABC + A (lbs)
210	60	70	76.8	270.0	20,800	78.9	268.5	14,900			
210	60	80	74.7	267.2	20,200	76.7	265.7	13,700	78.7	262.3	9,300
210	60	90	72.4	263.9	18,400	74.5	262.5	12,700	76.5	259.0	8,800
210	60	100	70.2	260.3	16,700	72.3	258.8	11,800	74.2	255.3	8,300
210	60	110	67.9	256.2	15,300	70.0	254.7	11,100	71.9	251.1	7,900
210	60	120	65.6	251.6	14,100	67.7	250.1	10,400	69.5	246.4	7,600
210	60	130	63.3	246.5	13,100	65.3	245.0	9,800	67.1	241.3	7,200
210	60	140	60.9	240.9	12,200	62.9	239.4	9,300	64.7	235.6	6,900
210	60	150	58.4	234.7	11,200	60.4	233.2	8,800	62.1	229.3	6,700
210	60	160	55.8	227.9	9,800	57.8	226.3	8,400	59.5	222.3	6,400
210	60	170	53.2	220.5	8,600	55.2	218.8	8,000	56.8	214.7	6,200
210	60	180	50.5	212.2	7,500	52.4	210.5	7,700	54.1	206.2	6,000
210	60	190	47.7	203.2	6,600	49.6	201.4	6,900	51.1	196.9	5,900
210	60	200	44.7	193.2	5,700	46.6	191.3	6,000	48.1	186.6	5,700
210	60	210	41.5	182.0	4,900	43.4	180.0	5,200			
210	60	220	38.2	169.5	4,300	40.0	167.4	4,500			
210	60	230	34.5	155.3	3,600	36.3	153.0	3,800			
210	60	240	30.5	138.9	3,100						
210	75	59.22	80.0	288.2	17,700						
210	75	60	79.8	288.1	17,700						
210	75	70	77.8	285.8	17,200						
210	75	80	75.7	283.2	16,700	78.2	281.7	11,200			
210	75	90	73.7	280.2	15,200	76.1	278.7	10,300	78.5	274.8	7,000
210	75	100	71.5	276.8	13,800	74.0	275.3	9,600	76.3	271.3	6,500
210	75	110	69.4	273.0	12,500	71.9	271.4	8,900	74.1	267.4	6,200
210	75	120	67.2	268.8	11,500	69.7	267.2	8,300	71.9	263.1	5,900
210	75	130	65.0	264.1	10,600	67.5	262.5	7,800	69.7	258.3	5,600
210	75	140	62.8	258.9	9,900	65.2	257.2	7,400	67.4	253.0	5,300
210	75	150	60.5	253.2	9,200	62.9	251.5	7,000	65.0	247.1	5,100
210	75	160	58.1	246.9	8,600	60.5	245.2	6,600	62.6	240.7	4,900
210	75	170	55.7	240.1	8,100	58.1	238.3	6,300	60.1	233.7	4,700
210	75	180	53.2	232.6	7,600	55.6	230.8	6,000	57.6	225.9	4,500
210	75	190	50.6	224.3	6,700	52.9	222.5	5,700	54.9	217.5	4,400
210	75	200	48.0	215.3	5,900	50.2	213.4	5,500	52.1	208.2	4,200
210	75	210	45.1	205.4	5,100	47.4	203.4	5,200	49.2	197.9	4,100
210	75	220	42.2	194.4	4,400	44.4	192.3	4,700	46.1	186.4	4,000
210	75	230	39.0	182.2	3,800	41.2	179.9	4,100			
210	75	240	35.6	168.4	3,200	37.7	165.9	3,500			

General Use Only. Refer to the Tubular Jib Notes for Open Throat Boom before operating the machine.

Boom Length (ft)	Jib Length (ft)	Jib Load Radius (ft)	Jib Angle to Boom								
			5 Degrees			15 Degrees			25 Degrees		
			Boom Angle (deg)	Jib Pt Height (ft)	Jib Capacity ABC + A (lbs)	Boom Angle (deg)	Jib Pt Height (ft)	Jib Capacity ABC + A (lbs)	Boom Angle (deg)	Jib Pt Height (ft)	Jib Capacity ABC + A (lbs)
210	75	250	31.9	152.7	2,700						
210	75	260	27.7	134.3	2,200						
220	30	49.31	80.0	254.5	24,000						
220	30	50	79.8	254.4	24,000						
220	30	60	77.5	252.3	24,000	78.7	251.5	24,000	79.7	249.7	22,400
220	30	70	75.2	249.7	24,000	76.3	248.9	24,000	77.3	247.1	21,500
220	30	80	72.8	246.7	24,000	73.9	245.9	24,000	74.9	244.1	20,500
220	30	90	70.4	243.3	24,000	71.5	242.5	24,000	72.5	240.6	19,600
220	30	100	68.0	239.3	21,800	69.1	238.5	22,300	70.0	236.6	18,800
220	30	110	65.5	234.9	18,600	66.6	234.1	19,000	67.5	232.1	18,100
220	30	120	62.9	229.9	16,000	64.0	229.1	16,300	65.0	227.1	16,600
220	30	130	60.3	224.4	13,800	61.4	223.5	14,100	62.3	221.4	14,400
220	30	140	57.7	218.2	11,900	58.7	217.3	12,200	59.6	215.2	12,400
220	30	150	54.9	211.4	10,300	56.0	210.5	10,600	56.8	208.3	10,800
220	30	160	52.1	203.8	8,900	53.1	202.9	9,200	53.9	200.6	9,400
220	30	170	49.1	195.4	7,700	50.1	194.4	7,900	50.9	192.0	8,100
220	30	180	46.0	186.0	6,700	47.0	185.0	6,900	47.8	182.5	7,000
220	30	190	42.7	175.6	5,700	43.7	174.5	5,900			
220	30	200	39.2	163.8	4,900	40.1	162.6	5,000			
220	30	210	35.4	150.3	4,100	36.3	149.1	4,300			
220	30	220	31.2	134.7	3,500						
220	30	230	26.4	116.1	2,800						
220	45	53.19	80.0	268.7	24,000						
220	45	60	78.5	267.3	24,000						
220	45	70	76.3	264.8	24,000	77.9	263.6	20,500	79.4	260.8	13,700
220	45	80	74.1	261.9	24,000	75.7	260.7	19,000	77.1	257.9	12,900
220	45	90	71.8	258.7	22,500	73.4	257.4	17,600	74.9	254.6	12,300
220	45	100	69.5	254.9	22,100	71.1	253.7	16,400	72.5	250.8	11,700
220	45	110	67.2	250.7	18,900	68.8	249.5	15,400	70.2	246.6	11,100
220	45	120	64.9	246.0	16,300	66.4	244.8	14,500	67.8	241.8	10,700
220	45	130	62.4	240.8	14,100	64.0	239.6	13,700	65.3	236.5	10,300
220	45	140	60.0	235.1	12,200	61.5	233.8	12,600	62.8	230.7	9,900
220	45	150	57.4	228.8	10,600	58.9	227.4	11,000	60.2	224.3	9,500
220	45	160	54.8	221.8	9,200	56.3	220.4	9,600	57.6	217.2	9,200
220	45	170	52.1	214.1	8,000	53.6	212.7	8,300	54.8	209.3	8,600
220	45	180	49.3	205.6	7,000	50.8	204.2	7,200	52.0	200.7	7,500
220	45	190	46.4	196.2	6,000	47.8	194.7	6,300	49.0	191.1	6,500

HC-238H II - w/ 62" x 70" Tube Boom, w/ 24" x 32" Tube Jib, w/ ABC + A Cwt

General Use Only. Refer to the Tubular Jib Notes for Open Throat Boom before operating the machine.

Boom Length (ft)	Jib Length (ft)	Jib Load Radius (ft)	Jib Angle to Boom								
			5 Degrees			15 Degrees			25 Degrees		
			Boom Angle (deg)	Jib Pt Height (ft)	Jib Capacity ABC + A (lbs)	Boom Angle (deg)	Jib Pt Height (ft)	Jib Capacity ABC + A (lbs)	Boom Angle (deg)	Jib Pt Height (ft)	Jib Capacity ABC + A (lbs)
220	45	200	43.3	185.8	5,200	44.7	184.3	5,400			
220	45	210	40.0	174.2	4,400	41.4	172.5	4,600			
220	45	220	36.5	161.1	3,700	37.8	159.3	3,900			
220	45	230	32.6	146.0	3,100						
220	45	240	28.3	128.4	2,500						
220	60	57.07	80.0	283.2	21,100						
220	60	60	79.4	282.6	20,900						
220	60	70	77.3	280.3	20,300	79.3	278.8	15,100			
220	60	80	75.2	277.6	19,800	77.2	276.1	13,900	79.1	272.7	9,400
220	60	90	73.1	274.5	18,900	75.1	273.0	12,900	77.0	269.5	8,900
220	60	100	70.9	271.0	17,200	72.9	269.5	12,000	74.8	265.9	8,400
220	60	110	68.8	267.0	15,700	70.7	265.5	11,300	72.6	261.9	8,000
220	60	120	66.5	262.7	14,500	68.5	261.1	10,600	70.3	257.5	7,700
220	60	130	64.3	257.8	13,500	66.3	256.3	10,000	68.0	252.5	7,300
220	60	140	62.0	252.5	12,500	63.9	250.9	9,500	65.7	247.1	7,000
220	60	150	59.6	246.6	10,900	61.6	245.0	9,000	63.3	241.1	6,800
220	60	160	57.2	240.1	9,500	59.1	238.5	8,600	60.8	234.5	6,500
220	60	170	54.7	233.0	8,300	56.6	231.4	8,200	58.3	227.3	6,300
220	60	180	52.2	225.3	7,200	54.1	223.6	7,600	55.6	219.4	6,100
220	60	190	49.5	216.8	6,300	51.4	215.0	6,600	52.9	210.6	5,900
220	60	200	46.7	207.4	5,400	48.6	205.6	5,700	50.1	201.0	5,800
220	60	210	43.8	197.1	4,600	45.6	195.2	4,900	47.0	190.4	5,100
220	60	220	40.8	185.6	4,000	42.5	183.6	4,200			
220	60	230	37.5	172.8	3,300	39.2	170.6	3,500			
220	60	240	33.9	158.3	2,800						
220	60	250	29.9	141.5	2,200						
220	75	60.96	80.0	298.1	17,300						
220	75	70	78.2	296.1	16,900						
220	75	80	76.2	293.6	16,500	78.6	292.0	11,400			
220	75	90	74.2	290.7	15,700	76.6	289.1	10,500	78.9	285.2	7,000
220	75	100	72.2	287.4	14,200	74.6	285.9	9,700	76.8	281.9	6,600
220	75	110	70.1	283.8	12,900	72.5	282.2	9,100	74.7	278.1	6,300
220	75	120	68.1	279.7	11,900	70.4	278.1	8,500	72.6	274.0	6,000
220	75	130	65.9	275.2	11,000	68.3	273.6	8,000	70.4	269.4	5,700
220	75	140	63.8	270.2	10,200	66.1	268.6	7,500	68.2	264.3	5,400
220	75	150	61.6	264.7	9,500	63.9	263.1	7,100	66.0	258.7	5,200
220	75	160	59.3	258.8	8,900	61.6	257.1	6,700	63.7	252.6	5,000

General Use Only. Refer to the Tubular Jib Notes for Open Throat Boom before operating the machine.

Boom Length (ft)	Jib Length (ft)	Jib Load Radius (ft)	Jib Angle to Boom								
			5 Degrees			15 Degrees			25 Degrees		
			Boom Angle (deg)	Jib Pt Height (ft)	Jib Capacity ABC + A (lbs)	Boom Angle (deg)	Jib Pt Height (ft)	Jib Capacity ABC + A (lbs)	Boom Angle (deg)	Jib Pt Height (ft)	Jib Capacity ABC + A (lbs)
220	75	170	57.0	252.3	8,300	59.3	250.5	6,400	61.3	245.9	4,800
220	75	180	54.7	245.1	7,400	56.9	243.4	6,100	58.9	238.6	4,600
220	75	190	52.2	237.4	6,400	54.5	235.5	5,800	56.4	230.6	4,400
220	75	200	49.7	228.9	5,600	51.9	227.0	5,600	53.8	221.8	4,300
220	75	210	47.1	219.6	4,800	49.3	217.6	5,200	51.1	212.2	4,200
220	75	220	44.3	209.4	4,100	46.5	207.3	4,400	48.2	201.7	4,100
220	75	230	41.4	198.1	3,500	43.5	195.9	3,800			
220	75	240	38.3	185.6	2,900	40.4	183.2	3,200			
220	75	250	35.0	171.5	2,400	37.0	168.8	2,600			
220	75	260	31.3	155.4	1,900						
220	75	270	27.2	136.6	1,500						
230	30	51.05	80.0	264.4	24,000						
230	30	60	78.0	262.5	24,000	79.1	261.7	24,000			
230	30	70	75.8	260.1	24,000	76.8	259.3	24,000	77.8	257.4	21,700
230	30	80	73.5	257.2	24,000	74.6	256.4	24,000	75.5	254.5	20,700
230	30	90	71.2	253.9	24,000	72.2	253.1	23,400	73.2	251.2	19,900
230	30	100	68.8	250.1	21,600	69.9	249.3	21,400	70.9	247.4	19,100
230	30	110	66.5	245.9	18,300	67.5	245.1	18,700	68.5	243.1	18,400
230	30	120	64.1	241.2	15,700	65.1	240.3	16,000	66.0	238.3	16,400
230	30	130	61.6	235.9	13,500	62.6	235.0	13,800	63.5	233.0	14,100
230	30	140	59.1	230.0	11,600	60.1	229.2	11,900	61.0	227.1	12,200
230	30	150	56.5	223.6	10,000	57.5	222.7	10,300	58.3	220.5	10,500
230	30	160	53.8	216.4	8,600	54.8	215.5	8,900	55.6	213.3	9,100
230	30	170	51.0	208.5	7,400	52.0	207.6	7,700	52.8	205.3	7,800
230	30	180	48.1	199.8	6,400	49.1	198.8	6,600	49.8	196.4	6,700
230	30	190	45.0	190.1	5,400	46.0	189.1	5,600	46.7	186.6	5,700
230	30	200	41.8	179.4	4,600	42.8	178.3	4,700			
230	30	210	38.4	167.2	3,800	39.3	166.1	4,000			
230	30	220	34.7	153.4	3,200	35.6	152.2	3,300			
230	30	230	30.6	137.5	2,500						
230	45	54.93	80.0	278.5	24,000						
230	45	60	78.9	277.5	24,000						
230	45	70	76.8	275.1	23,300	78.4	273.9	20,900	79.8	271.1	13,800
230	45	80	74.7	272.4	21,300	76.2	271.1	19,300	77.6	268.3	13,100
230	45	90	72.5	269.2	20,700	74.0	268.0	17,900	75.4	265.1	12,400
230	45	100	70.3	265.6	20,000	71.8	264.4	16,800	73.2	261.5	11,800
230	45	110	68.1	261.6	18,700	69.6	260.4	15,700	71.0	257.5	11,300

HC-238H II - w/ 62" x 70" Tube Boom, w/ 24" x 32" Tube Jib, w/ ABC + A Cwt

General Use Only. Refer to the Tubular Jib Notes for Open Throat Boom before operating the machine.

Boom Length (ft)	Jib Length (ft)	Jib Load Radius (ft)	Jib Angle to Boom								
			5 Degrees			15 Degrees			25 Degrees		
			Boom Angle (deg)	Jib Pt Height (ft)	Jib Capacity ABC + A (lbs)	Boom Angle (deg)	Jib Pt Height (ft)	Jib Capacity ABC + A (lbs)	Boom Angle (deg)	Jib Pt Height (ft)	Jib Capacity ABC + A (lbs)
230	45	120	65.8	257.1	16,000	67.3	255.9	14,900	68.7	252.9	10,800
230	45	130	63.5	252.2	13,800	65.0	250.9	14,100	66.3	247.9	10,400
230	45	140	61.2	246.7	11,900	62.6	245.4	12,400	63.9	242.3	10,000
230	45	150	58.8	240.7	10,300	60.2	239.4	10,700	61.5	236.2	9,700
230	45	160	56.3	234.0	8,900	57.7	232.7	9,300	59.0	229.5	9,400
230	45	170	53.7	226.8	7,700	55.2	225.4	8,100	56.4	222.1	8,300
230	45	180	51.1	218.8	6,700	52.5	217.4	7,000	53.7	214.0	7,200
230	45	190	48.4	210.0	5,700	49.7	208.6	6,000	50.9	205.0	6,200
230	45	200	45.5	200.4	4,900	46.9	198.8	5,100	47.9	195.1	5,300
230	45	210	42.5	189.6	4,100	43.8	188.0	4,300			
230	45	220	39.3	177.7	3,400	40.6	176.0	3,600			
230	45	230	35.8	164.2	2,800	37.1	162.4	3,000			
230	45	240	32.0	148.8	2,200						
230	45	250	27.7	130.8	1,700						
230	60	58.81	80.0	293.1	20,200						
230	60	60	79.8	292.8	20,200						
230	60	70	77.8	290.6	19,600	79.7	289.1	15,300			
230	60	80	75.7	288.0	19,000	77.7	286.5	14,100	79.5	283.0	9,500
230	60	90	73.7	285.0	18,400	75.6	283.5	13,100	77.4	280.0	9,000
230	60	100	71.6	281.6	17,700	73.6	280.1	12,300	75.3	276.6	8,500
230	60	110	69.5	277.8	16,200	71.4	276.3	11,500	73.2	272.7	8,100
230	60	120	67.4	273.6	15,000	69.3	272.1	10,800	71.1	268.4	7,800
230	60	130	65.2	269.0	13,900	67.1	267.4	10,200	68.9	263.7	7,400
230	60	140	63.0	263.9	12,200	64.9	262.3	9,700	66.6	258.5	7,100
230	60	150	60.8	258.2	10,600	62.7	256.7	9,200	64.3	252.8	6,900
230	60	160	58.5	252.1	9,200	60.4	250.5	8,800	62.0	246.5	6,600
230	60	170	56.1	245.4	8,000	58.0	243.7	8,400	59.6	239.7	6,400
230	60	180	53.7	238.0	6,900	55.5	236.3	7,300	57.1	232.1	6,200
230	60	190	51.2	230.0	6,000	53.0	228.3	6,300	54.5	223.9	6,000
230	60	200	48.6	221.2	5,100	50.4	219.4	5,400	51.8	214.9	5,700
230	60	210	45.9	211.6	4,300	47.6	209.7	4,600	49.0	205.0	4,900
230	60	220	43.0	201.0	3,600	44.7	199.0	3,900			
230	60	230	40.0	189.2	3,000	41.7	187.1	3,200			
230	60	240	36.8	176.0	2,400	38.4	173.8	2,600			
230	60	250	33.3	161.2	1,900						
230	75	62.69	80.0	307.9	16,900						
230	75	70	78.6	306.4	16,600						

General Use Only. Refer to the Tubular Jib Notes for Open Throat Boom before operating the machine.

Boom Length (ft)	Jib Length (ft)	Jib Load Radius (ft)	Jib Angle to Boom								
			5 Degrees			15 Degrees			25 Degrees		
			Boom Angle (deg)	Jib Pt Height (ft)	Jib Capacity ABC + A (lbs)	Boom Angle (deg)	Jib Pt Height (ft)	Jib Capacity ABC + A (lbs)	Boom Angle (deg)	Jib Pt Height (ft)	Jib Capacity ABC + A (lbs)
230	75	80	76.7	303.9	16,100	79.0	302.3	11,500			
230	75	90	74.7	301.2	15,700	77.1	299.6	10,700	79.3	295.6	7,100
230	75	100	72.8	298.0	14,600	75.1	296.4	9,900	77.3	292.4	6,700
230	75	110	70.8	294.5	13,300	73.1	292.9	9,200	75.3	288.8	6,300
230	75	120	68.8	290.5	12,200	71.1	288.9	8,700	73.2	284.8	6,000
230	75	130	66.8	286.2	11,300	69.1	284.6	8,100	71.1	280.4	5,700
230	75	140	64.7	281.4	10,500	67.0	279.8	7,700	69.0	275.5	5,500
230	75	150	62.6	276.2	9,800	64.9	274.5	7,300	66.9	270.1	5,200
230	75	160	60.5	270.5	9,100	62.7	268.8	6,900	64.7	264.3	5,000
230	75	170	58.3	264.3	8,200	60.5	262.5	6,600	62.4	257.9	4,800
230	75	180	56.0	257.5	7,100	58.2	255.7	6,300	60.1	251.0	4,700
230	75	190	53.7	250.1	6,100	55.9	248.3	6,000	57.7	243.4	4,500
230	75	200	51.3	242.1	5,300	53.4	240.2	5,700	55.3	235.1	4,400
230	75	210	48.8	233.3	4,500	50.9	231.4	4,900	52.7	226.1	4,200
230	75	220	46.2	223.8	3,800	48.3	221.7	4,200	50.1	216.2	4,100
230	75	230	43.5	213.3	3,200	45.6	211.1	3,500	47.3	205.4	3,800
230	75	240	40.7	201.7	2,600	42.7	199.4	2,900			
230	75	250	37.6	188.9	2,100	39.6	186.4	2,300			
230	75	260	34.4	174.5	1,600	36.3	171.8	1,800			

Specifications

Lattice Boom Crawler Crane With Luffing Attachment

LS-248H 11

42.5 -Ton (38.5 metric ton)

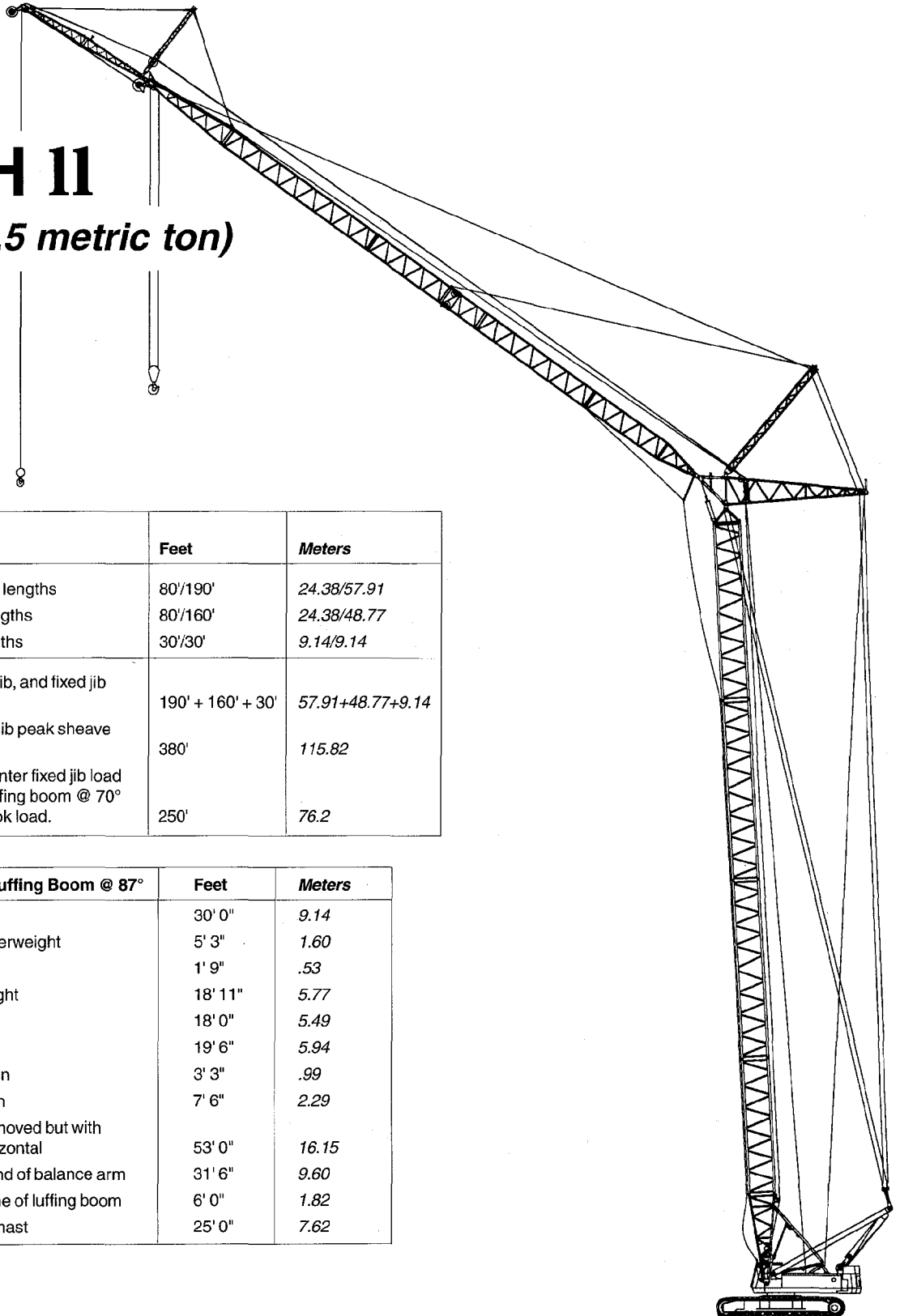

Luffing Boom - Luffing Jib - Fixed Jib Combinations	Feet	Meters
Basic & maximum luffing boom lengths	80'/190'	24.38/57.91
Basic & maximum luffing jib lengths	80'/160'	24.38/48.77
Basic & maximum fixed jib lengths	30'/30'	9.14/9.14
Maximum luffing boom, luffing jib, and fixed jib combination lengths	190' + 160' + 30'	57.91+48.77+9.14
Maximum height - center fixed jib peak sheave @ 75' (22.86 m) radius	380'	115.82
Maximum horizontal reach - center fixed jib load hook @ max. chart radius w/luffing boom @ 70° offset - 5,400 lb. (2 449 kg) hook load.	250'	76.2

General Dimensions - 190' Luffing Boom @ 87°	Feet	Meters
Luffing boom live mast	30' 0"	9.14
Ground clearance under counterweight	5' 3"	1.60
Minimum ground clearance	1' 9"	.53
Tailswing of "ABC" counterweight	18' 11"	5.77
Tailswing of balance arm	18' 0"	5.49
Radius of luffing jib hinge pin	19' 6"	5.94
Radius of luffing boom hinge pin	3' 3"	.99
Height of luffing boom hinge pin	7' 6"	2.29
Overall length - attachment removed but with luffing boom mast lowered horizontal	53' 0"	16.15
Centerline of luffing boom to end of balance arm	31' 6"	9.60
Luffing jib hinge pin to centerline of luffing boom	6' 0"	1.82
Tail swing of luffing boom live mast	25' 0"	7.62

Nomenclature

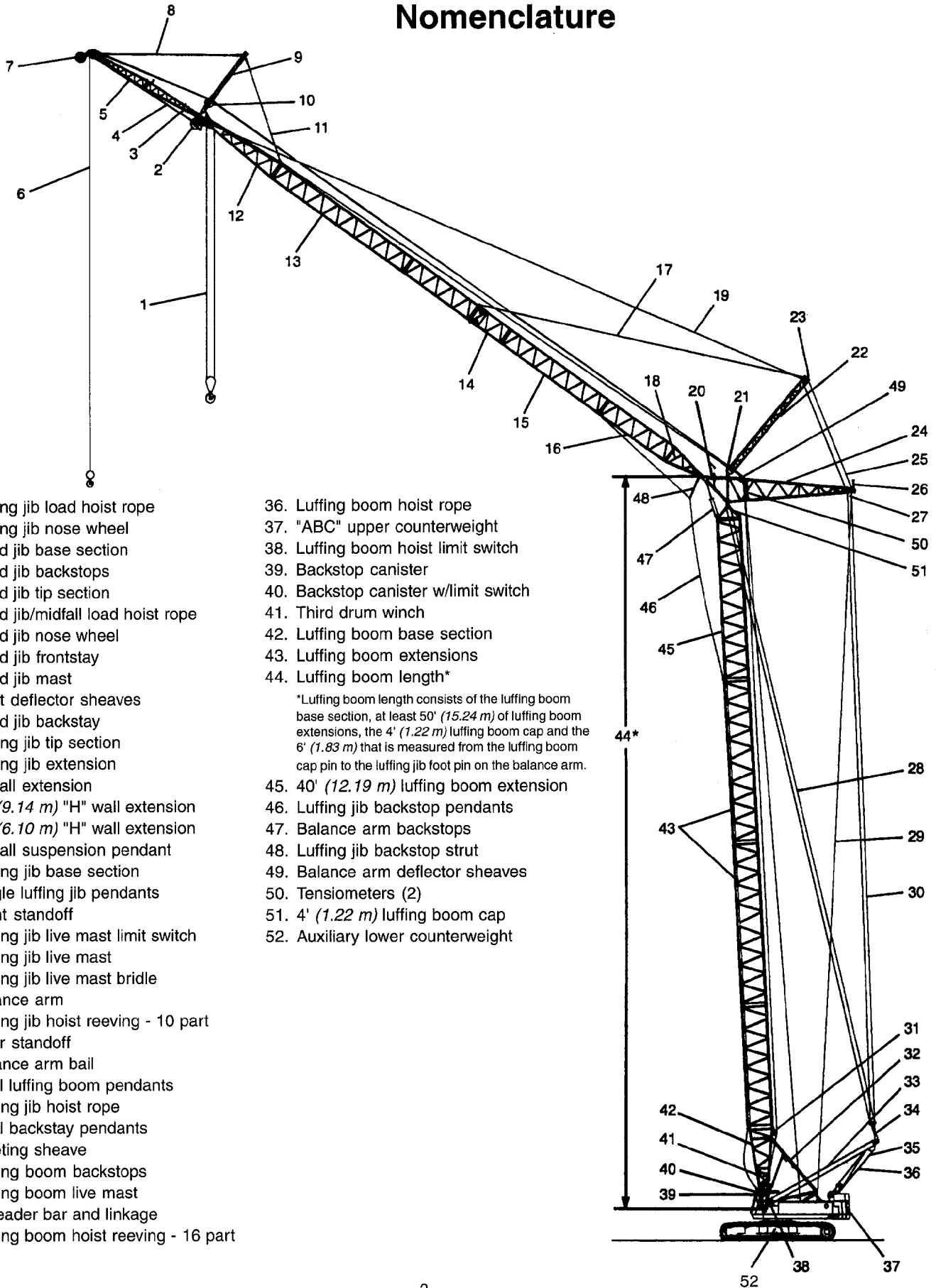

1. Luffing jib load hoist rope
2. Luffing jib nose wheel
3. Fixed jib base section
4. Fixed jib backstops
5. Fixed jib tip section
6. Fixed jib/midfall load hoist rope
7. Fixed jib nose wheel
8. Fixed jib frontstay
9. Fixed jib mast
10. Mast deflector sheaves
11. Fixed jib backstay
12. Luffing jib tip section
13. Luffing jib extension
14. Midfall extension
15. 30' (9.14 m) "H" wall extension
16. 20' (6.10 m) "H" wall extension
17. Midfall suspension pendant
18. Luffing jib base section
19. Single luffing jib pendants
20. Front standoff
21. Luffing jib live mast limit switch
22. Luffing jib live mast
23. Luffing jib live mast bridle
24. Balance arm
25. Luffing jib hoist reeving - 10 part
26. Rear standoff
27. Balance arm bail
28. Dual luffing boom pendants
29. Luffing jib hoist rope
30. Dual backstay pendants
31. Fleeting sheave
32. Luffing boom backstops
33. Luffing boom live mast
34. Spreader bar and linkage
35. Luffing boom hoist reeving - 16 part

36. Luffing boom hoist rope
37. "ABC" upper counterweight
38. Luffing boom hoist limit switch
39. Backstop canister
40. Backstop canister w/limit switch
41. Third drum winch
42. Luffing boom base section
43. Luffing boom extensions
44. Luffing boom length*
45. 40' (12.19 m) luffing boom extension
46. Luffing jib backstop pendants
47. Balance arm backstops
48. Luffing jib backstop strut
49. Balance arm deflector sheaves
50. Tensiometers (2)
51. 4' (1.22 m) luffing boom cap
52. Auxiliary lower counterweight

*Luffing boom length consists of the luffing boom base section, at least 50' (15.24 m) of luffing boom extensions, the 4' (1.22 m) luffing boom cap and the 6' (1.83 m) that is measured from the luffing boom cap pin to the luffing jib foot pin on the balance arm.

General Specifications

■ Luffing Boom

Tubular; 80" (2.03 m) wide, 68" (1.72 m) deep at connections. Alloy steel round tubular chords 4.0 (1.0 m) outside diameter.

■ Luffing Boom Base Section

20' (6.09 m) long. Luffing boom feet on 55" (1.39 m) centers. Hydraulic powered luffing boom foot pin removal system standard.

■ Luffing Boom Extensions

Available in 10' (3.04 m), 20' (6.08 m), 30' (9.14 m) and 40' (12.19 m) lengths with appropriate length pendants.

■ Luffing Boom Connections

In-line pin connections

■ Luffing Boom Cap

4' 0" (1.21 m) long; tubular construction, pin connected to the top luffing boom extension.

■ Balance Arm

Provides an offset luffing jib connection to allow for a full 165° of luffing jib angle variation from erection to minimum radius operating position. Transfers the resultant of the luffing jib foot thrust to the luffing boom centerline so that all four chords are loaded equally. Tubular construction, front chords span 6' 0" (1.82 m) from luffing boom centerline and rear chords span 30' 0" (9.14 m) from luffing boom centerline to the luffing jib hoist bail shaft.

■ Luffing Boom Stops

Dual lever type, spring cushioned. Adjustable levers pin to luffing boom base section; backstops anchor to the upper revolving frame. Required for all luffing boom lengths.

■ Luffing Boom Hoist Bridle

The 16 part conventional boom hoist becomes the luffing boom hoist with no re-reeving required.

■ Luffing Boom Live Mast

Welded plate/tube construction 30' 0" (9.14 m) long, required for all luffing boom/luffing jib lengths; supports luffing jib hoist bridle. (Same live mast as on standard crane.)

■ Balance Arm Stops

Spring canisters with links that position the balance arm centerline approximately perpendicular to the luffing boom.

■ Wire Rope

See chart on page 4.

■ Basic Luffing Boom

80' (24.38 m) long; contains one 20' 0" (6.09 m) base section, one 10' 0" (3.04 m), one 40' 0" (12.19 m) extension, 4' 0" (1.21 m) tapered luffing boom cap and 6' 0" (1.82 m) balance arm. (Includes live mast, 10-part bridle and bail machinery, spreader bar and luffing jib backstop system.)

■ Maximum Luffing Boom

No assist luffing boom erection; 190' (57.91 m) luffing boom for use with maximum 160' (48.76 m) luffing jib and 30' (9.14 m) fixed jib.

■ Luffing Jib - 218A/218H Conventional Boom

Tubular; basic luffing jib 80' (24.38 m) long; 60" (1.52 m) wide, 50" (1.27 m) deep at connections. Alloy steel round tubular chords 3.0" (.07 m) outside diameter.

■ Luffing Jib Base Section

10' 0" (3.04 m) long; 80" (2.03 m) wide at luffing jib foot. 50" (1.27 m) deep and 60" (1.52 m) wide at pin connections.

■ Luffing Jib Extensions - .220" (5.59 mm) Wall

Available in 10' (3.04 m), 20' (6.10 m), 30' (9.14 m) and 40' (12.19 m) lengths with appropriate length pendants. (218A/218H extensions)

■ Luffing Jib Extensions - .259" Wall

Available in 20' (6.10 m) and 30' (9.14 m) lengths with appropriate length pendants. (218A/218H extensions). Required for first 50' (15.24 m) of luffing jib extensions.

■ Luffing Jib Connections

In-line pin connections.

■ Top Section - Luffing Jib

Open throat, 20' (6.09 m) long. (218A/218H top section)

■ Luffing Jib Live Mast

30' (9.14 m) long, required for all luffing jib/fixed jib lengths.

■ Luffing Jib Point Machinery

Five 21" (.53 m) root diameter sheaves. Sheaves mounted on anti-friction bearings.

■ Deflector Rollers

Deflect load hoist wire rope off luffing boom/luffing jib. Steel rollers mounted on anti-friction pillow block bearings.

■ Luffing Jib Backstop System

3/4" (19 mm) wire rope type "N" pendants. Contains spring canisters and a limit switch to prevent luffing jib from exceeding maximum operating angle.

■ Luffing Jib Hoist

1" (25 mm) type "N" luffing jib hoist line runs from the rear drum to the balance arm bail. Ten part reeving hoists luffing jib from -75° to 0° during erection and from 0° to 75° during operation.

■ Luffing Jib Hoist Limiting Device

One of the luffing jib backstop canisters is equipped with a luffing jib hoist limit switch used to avoid hoisting above minimum radius. Brakes apply automatically.

■ Drum Rotation Indicators

Standard for front drum (load hoist) and rear drum (luffing jib hoist).

■ Luffing Jib Lengths

Luffing jib lengths from 80' (24.38 m) to 160' (48.77 m) may be used on all luffing boom lengths from 80' (24.38 m) to 180' (54.86 m) with luffing boom angles at 87°, 85°, 80°, 75°, 70° and 65° angles.

■ Luffing Jib Nose Wheels

Pin-connected to end of luffing jib top section; support luffing jib peak on ground during luffing boom and luffing jib erection.

■ Luffing Boom And Luffing Jib Angle Indicators

Electronic type standard. Read out unit conveniently located in crane operator's cab.

■ Capacities

Available for luffing boom angles of 87°, 80°, 85°, 75°, and 70°.

■ Fixed Jib

Tubular; basic two-piece 30' (9.14 m) long; 32" (.81 m) wide; 24" (.51 m) deep at connections. Alloy steel round tubular chords 2-1/4" (57 mm) outside diameter. (Same jib as used on conventional LS-248H II boom.)

■ Base Section - Fixed Jib

15' 0" (4.57 m) long.

■ Jib Connections

In-line pin connections.

General Specifications (con't)

Tip section - Fixed Jib

15' 0" (4.57 m) long; equipped with single 21" (.53 m) root diameter sheave, mounted on anti-friction bearings.

Jib Adapter

Connects to the fixed jib lower section and the luffing jib upper section. Allows the fixed jib to pivot 90° to the luffing jib for erection purposes.

Jib Mast

17' 10" (5.43 m) long. Single jib load hoist rope (whipline) deflector sheave, 21" (.53 m) root diameter, mounted on anti-friction bearings. Two stayline equalizer sheaves mount at end of mast.

Fixed Jib Stops

Wire rope type; pin to fixed jib peak and to axle of luffing jib nose wheel.

Jib Staylines

Front and back staylines attach jib head shaft and luffing jib tip section to the jib mast respectively. Connections at the jib mast employ equalizing sheaves for both stays.

Fixed Jib Lengths And Offset Angles

30' (9.14 m) only; 5° offset only.

Fixed Jib Nose Wheel

Pin connected to jib peak; supports jib peak on ground during luffing boom/luffing jib/fixed jib erection.

3rd Drum Winch

Optional; used in conjunction with 30' (9.14 m) fixed jib as a whipline function.

Bolts in the luffing boom base section, 8' 0" (2.44 m) from the luffing boom foot pin. The winch drive consists of a variable displacement bent axis piston motor with an integral multi-disk brake and planetary. This drum is grooved for 1" (25.4 mm) rope.

Hydraulic power to the winch is supplied by a separate pump.

Quick disconnects at the outside of the machinery house allow the winch to be transported in the luffing boom lower section.

The hydraulic circuit contains a holding valve, which when coupled with the winch multi-disk brake will prevent load droop when initiating a hoist function. A ratchet-pawl system is not available.

Wire Rope and Rope Drum Data

Wire Rope: size and type

Wire rope application	Size: diameter		Type
	inches	mm	
Luffing boom hoist	1	25	LB
Luffing jib hoist	1	25	N
Main load hoist	1	25	N
Jib load hoist (1-part)	1	25	RB
Jib load hoist (2-part)	1	25	N
Luffing boom pendants (dual)	1	25	N
Backstay pendants (dual)	1	25	N
Luffing jib pendants (dual)	1-3/8	35	N
Jib front stay line	7/8	22	N
Jib back stay line	3/4	19	N
Luffing jib backstop pendants	3/4	19	N
Fixed jib backstop pendants	1/2	13	N
Midfall suspension pendants	3/4	19	N

Wire Rope: types available

- Type "N" - 6 x 25 (6 x 19 class) filler wire, extra improved plow steel, preformed, independent wire rope center, right lay, regular lay.
- Type "RB" - 19 x 19 rotation resistant.
- Type "LB" - 6 x 25 (6 x 19 class)

Drum Functions

Description	Lift Crane Function	Luffing Attachment Function
Front drum	Main load line	Main load line or whip line
Rear drum	Whip line	Luffing jib hoist
Boom hoist drum	Boom hoist	Luffing boom hoist
3rd drum	n/a	Whip line

Third Drum Winch Performance

Line speed and pull

High Speed							
1.0" (25 mm) Dia. Rope	Maximum Line Pull		No Load Line Speed		Full Load Line Speed		
	Layer	lbs.	kg	fpm	m/min	fpm	m/min
	1	9,030	4 090	460	140	220	67
	2	8,200	3 720	510	155	250	76
	3	7,500	3 400	560	170	270	82
	4	6,920	3 130	610	185	290	88
	5	6,420	2 910	650	200	320	97
	6	5,990	2 715	700	215	340	104

Low Speed							
1.0" (25 mm) Dia. Rope	Maximum Line Pull		No Load Line Speed		Full Load Line Speed		
	Layer	lbs.	kg	fpm	m/min	fpm	m/min
	1	19,470	8 830	260	79	85	26
	2	17,680	8 020	290	88	95	29
	3	16,190	7 340	320	97	105	32
	4	14,930	6 770	340	105	110	33
	5	13,850	6 280	370	110	120	36
	6	12,910	5 860	400	120	130	39

Jobsite Travel (without load)

The LS-248H II with luffing attachment may be moved on the jobsite with all combinations of luffing boom, luffing jib, and fixed jib.

Set luffing boom at 80° and luffing jib at 0° to +60° for all travel conditions.

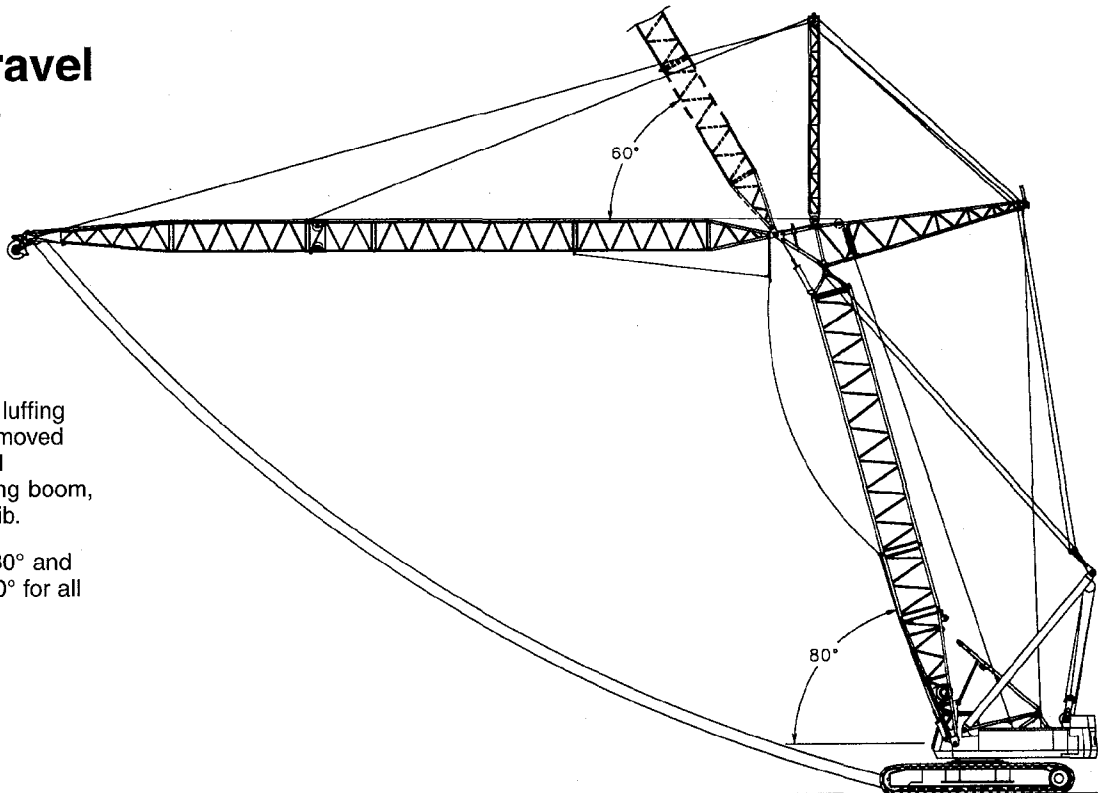

Over Front or Rear

LS-248H II Luffing Crane Capacities

Refer to notes page 6

Luffing Boom - Tubular; 80" (2.03 m) wide, 68" (1.73 m) deep.

Fixed Jib - Tubular; 32" (.81 m) wide, 24" (.61m) deep.

Upper Counterweights - "ABC" cwt., 96,430 lbs. (43 741 kg)

Luffing Jib - Tubular; 60" (1.52 m) wide, 50" (1.27 m) deep.

Mounting - Crawler; 18' 10" (5.74 m) gauge, 28' 6" (8.69 m) overall length.

Lower Counterweights - "A" cwt., 48,000 lbs. (21 773 kg)

Luffing boom and luffing jib + fixed jib machine can **lift off** ground unassisted, without load.

Standard LS-248H II must be equipped with the counterweights listed below when the indicated luffing boom and luffing jib + fixed jib lengths are used.	Luffing boom and luffing jib + fixed jib lengths allowed	Over End (folded or flat)					
		Luffing Boom		Luffing Jib		Fixed Jib	
		Feet	meters	Feet	meters	Feet	meters
Upper Cwt. "ABC" + Lower Cwt. "A"	Minimum	80	24.38	80	24.38	30	9.14
	① Maximum	190	57.91	160	48.77	30	9.14

① Lift off of luffing boom lengths 170' - 190' (51.82 - 57.91 m) requires blocked idler/sprocket.

Machine **travel** with luffing boom and luffing jib + fixed jib, with no load.

Standard LS-248H II must be equipped with the counterweights listed below when the indicated luffing boom and luffing jib + fixed jib lengths are used.	Luffing boom and luffing jib + fixed jib lengths allowed	Jobsites moves at 1 mph (1.61 km/h) with luffing boom and luffing jib + fixed jib. ②			
		Luffing Boom		Luffing Jib + Fixed Jib	
		Feet	meters	Feet	meters
Upper Cwt. "ABC" + Lower Cwt. "A"	Minimum	80	24.38	80 + 30	24.38 + 9.14
	Maximum	190	57.91	160 + 30	48.77 + 9.14

② Refer to travel charts for luffing boom and jib angles before moving.

Working Areas

1. These lines determine the limiting position of any load for operation within working areas indicated.

Caution: This material is for reference only. Operator must refer to in-cab crane rating manual to determine allowable machine lifting capacities and operating procedures.

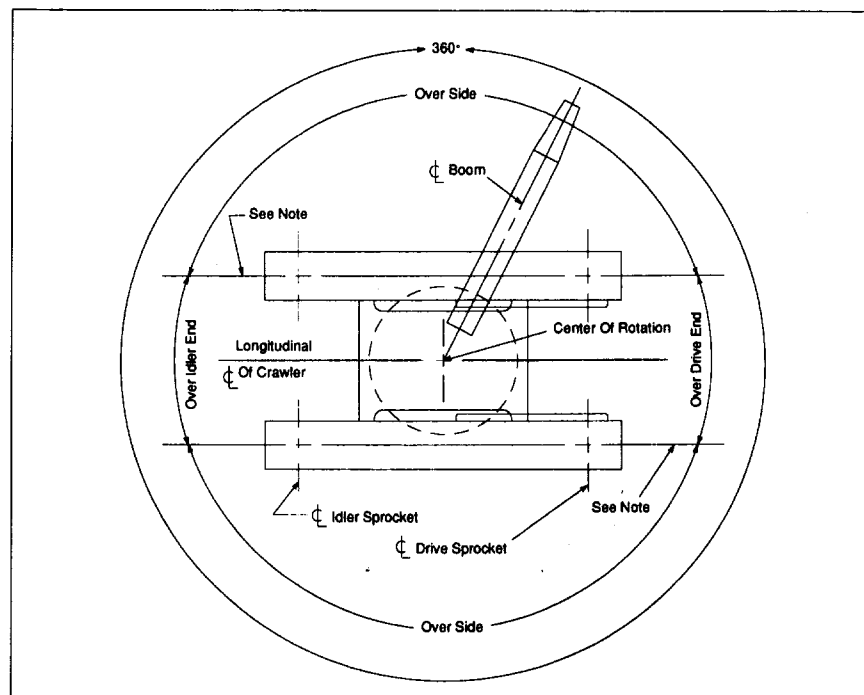

LS-248H II Luffing Crane Capacities

Luffing Boom Length	Luffing Jib Length	Radii In Feet	360 Degrees						Over-the-End (Blocked)					
			Luffing Boom Angle						Luffing Boom Angle					
			87°	85°	80°	75°	70°	65°	87°	85°	80°	75°	70°	65°
80'	80'	38	85.0*	-	-	-	-	-	85.0*	-	-	-	-	-
		60	60.5	59.9	58.2	-	-	-	69.9	69.9	69.9	-	-	-
		80	42.2	41.7	40.5	39.4	-	-	49.8	49.3	48.1	46.9	-	-
		100	-	-	30.5	29.6	28.1	27.3	-	-	36.2	35.3	34.4	33.6
		120	-	-	-	-	-	21.6	-	-	-	-	-	26.4
		123	-	-	-	-	-	21.0	-	-	-	-	-	25.6
	100'	43	68.3*	-	-	-	-	-	68.3*	-	-	-	-	-
		60	60.0	59.3	-	-	-	-	63.1*	63.0*	-	-	-	-
		80	41.7	41.2	40.0	38.8	-	-	49.4	48.9	47.6	46.3	-	-
		100	31.4	31.0	30.1	29.1	27.5	27.5	37.2	36.8	35.8	34.9	33.9	-
		120	-	-	23.7	22.9	21.7	21.2	-	-	28.2	27.5	26.7	26.0
		143	-	-	-	-	-	16.7	-	-	-	-	-	21.2
	120'	50	54.1*	-	-	-	-	-	54.1*	-	-	-	-	-
		80	41.2	40.7	39.4	-	-	-	48.9	48.4	45.9*	-	-	-
		100	30.9	30.5	29.5	28.5	-	-	36.7	36.3	35.3	34.3	-	-
		120	24.4	24.0	23.2	22.4	21.3	20.5	26.3*	28.6	27.8	27.0	26.2	25.4
		140	-	-	19.0	18.3	17.3	16.7	-	-	22.6	21.9	21.3	20.8
		163	-	-	-	-	-	13.8	-	-	-	-	-	17.2
	140'	58	43.6*	-	-	-	-	-	43.6*	-	-	-	-	-
		80	40.4*	40.0*	-	-	-	-	40.4*	40.0*	-	-	-	-
		100	30.4	30.0	28.9	-	-	-	36.3	35.8	34.8	-	-	-
		120	23.9	23.5	22.7	21.8	20.7	20.7	25.3*	28.1	27.3	26.4	25.6	-
		140	17.0*	18.9*	18.5	17.8	16.7	16.0	17.0*	18.9*	22.1	21.4	20.9	20.2
		183	-	-	15.3	14.7	13.8	13.2	-	-	17.7*	17.9	17.3	16.7
160'	67	34.7*	-	-	-	-	-	34.7*	-	-	-	-	-	
	80	33.1*	33.1*	-	-	-	-	33.1*	33.1*	-	-	-	-	
	100	29.9	29.4	28.4	-	-	-	31.5*	31.5*	30.7*	-	-	-	
	120	23.3	23.0	22.1	21.2	-	-	24.3*	26.8*	26.7	25.8	-	-	
	140	14.8*	17.7*	18.0	17.3	16.1	16.1	14.8*	17.7*	21.6	21.1	20.4	-	
	160	9.6*	11.5*	14.8	14.2	13.2	12.6	9.6*	11.5*	17.2*	17.4	16.8	16.2	
160' + 30'	80	18.0*	-	-	-	-	-	18.0*	-	-	-	-	-	
	100	18.0*	18.0*	-	-	-	-	18.0*	18.0*	-	-	-	-	
	120	17.8*	18.0*	18.0*	-	-	-	17.8*	18.0*	18.0*	-	-	-	
	140	12.4*	15.4*	16.2*	16.4	-	-	12.4*	15.4*	16.2*	16.9*	-	-	
	160	6.7*	9.2*	13.7*	13.4	12.3	12.3	6.7*	9.2*	13.7*	14.4*	14.9*	12.7	
	200	-	-	9.2*	11.0	10.1	9.6	-	-	9.2*	11.9*	12.7*	10.6	
100'	80'	39	79.7*	-	-	-	-	-	79.7*	-	-	-	-	
		60	60.6	59.7	57.6	-	-	-	72.5	71.5	69.3	-	-	
		80	42.2	41.6	40.1	38.6	-	-	49.9	49.2	47.7	46.1	-	
		100	-	-	30.1	29.0	27.1	27.1	-	-	35.9	34.7	33.6	-
		120	-	-	-	-	21.5	20.8	-	-	-	-	26.4	25.5
		131	-	-	-	-	-	18.4	-	-	-	-	-	22.6
	100'	44	64.6*	-	-	-	-	-	64.6*	-	-	-	-	-
		60	60.0	59.1	-	-	-	-	60.5*	60.6*	-	-	-	-
		80	41.7	41.1	39.5	-	-	-	49.4	48.8	47.1	-	-	-
		100	31.4	30.9	29.6	28.4	26.4	26.4	37.2	36.7	35.5	34.2	33.0	-
		120	-	-	23.4	22.4	21.1	20.1	-	-	27.9	26.9	25.9	25.0
		151	-	-	-	-	17.1	16.4	-	-	-	-	21.2	20.5
	120'	50	51.4*	-	-	-	-	-	51.4*	-	-	-	-	-
		80	41.2	40.6	38.9	-	-	-	47.1*	46.6*	46.0*	-	-	-
		100	30.9	30.4	29.1	27.8	-	-	36.8	36.3	34.9	33.6	-	-
		120	24.3	23.9	22.8	21.8	20.4	20.4	25.7*	28.5	27.5	26.4	25.4	-
		140	-	-	18.7	17.8	16.6	15.8	-	-	22.3	21.4	20.8	19.9
		171	-	-	-	-	13.7	13.0	-	-	-	-	17.2	16.5
	140'	55	41.8*	-	-	-	-	-	41.8*	-	-	-	-	-
		80	38.5*	38.1*	-	-	-	-	38.5*	38.1*	-	-	-	-
		100	30.4	29.8	28.5	-	-	-	35.2*	35.8	34.4	-	-	-
		120	23.8	23.4	22.3	21.2	-	-	24.1*	28.0	26.9	25.8	-	-
		140	16.8*	19.2	18.2	17.3	16.0	15.1	16.8*	19.3*	21.8	21.1	20.2	19.4
		191	-	-	15.0	14.2	13.1	12.4	-	-	18.3	17.5	16.7	16.0
160'	61	33.4*	-	-	-	-	-	33.4*	-	-	-	-	-	
	80	31.4*	31.5*	-	-	-	-	31.4*	31.5*	-	-	-	-	
	100	29.8	29.3	27.9	-	-	-	30.5*	30.1*	29.4*	-	-	-	
	120	23.2*	22.8	21.7	20.9	-	-	23.2*	26.3*	26.4	25.2	-	-	
	140	14.8*	18.1*	17.7	16.8	15.3	15.3	14.8*	18.1*	21.3	20.6	19.7	-	
	211	9.8*	11.9*	14.5	13.7	12.5	11.8	9.8*	11.9*	17.8	17.0	16.2	15.4	
160' + 30'	73	18.0	-	-	-	-	-	18.0*	-	-	-	-	-	
	100	18.0	18.0	-	-	-	-	18.0*	18.0*	18.0*	-	-	-	
	120	17.3	17.9	18.0	-	-	-	17.3*	17.9*	16.2*	17.1*	-	-	
	140	12.5	15.1	16.2	15.9	-	-	12.5*	15.1*	16.2*	14.7*	15.3	-	
	160	7.0	9.8	13.7	12.9	11.6	11.6	7.0*	9.8*	13.8*	12.3*	12.7	12.0	
	200	-	-	11.2	10.6	9.5	8.8	-	-	11.2*	12.3*	10.6	10.0	
160' + 30'	180	-	-	5.5	8.8	7.8	7.2	-	-	5.5*	10.0*	8.9	8.3	
	200	-	-	-	5.1	6.5	5.9	-	-	-	5.1*	8.9	8.3	
	220	-	-	-	-	-	-	-	-	-	-	-	6.9	
	241	-	-	-	-	-	-	-	-	-	-	-	6.9	

NOTE: *Indicates these capacities are based on factors other than those which would cause a tipping condition. Capacities shown in thousands of pounds.

LS-248H II Luffing Crane Capacities

Luffing Boom Length	Luffing Jib Length	Radii In Feet	360 Degrees						Over-the-End (Blocked)					
			Luffing Boom Angle						Luffing Boom Angle					
			87°	85°	80°	75°	70°	65°	87°	85°	80°	75°	70°	65°
190'	140'	60	22.6*	-	-	-	-	-	22.6	-	-	-	-	-
		80	21.2*	22.7*	-	-	-	-	21.2	22.7	-	-	-	-
		100	19.0*	20.9*	22.9*	-	-	-	19.0	20.9	22.9	-	-	-
		120	16.1*	19.0*	20.3	-	-	-	16.1	19.0	20.3	-	-	-
		140	11.7*	14.0*	16.3	14.2	-	-	11.7	14.0	17.9	17.8	-	-
		160	-	10.1*	13.3	11.5	9.3	-	-	10.1	15.8	14.9	13.2	-
		180	-	-	11.1	9.5	7.6	6.1	-	-	11.4	12.4	10.9	9.4
		200	-	-	-	-	6.2	-	-	-	-	-	9.1	7.7
		220	-	-	-	-	-	-	-	-	-	-	-	6.4
	229	-	-	-	-	-	-	-	-	-	-	-	-	5.8
	160'	65	18.8*	-	-	-	-	-	18.8	-	-	-	-	-
		80	18.1*	19.1*	-	-	-	-	18.1	19.1	-	-	-	-
		100	16.7*	18.2*	-	-	-	-	16.7	18.2	-	-	-	-
		120	14.4*	16.5*	17.6*	-	-	-	14.4	16.5	17.6	-	-	-
		140	10.1*	12.8*	15.6*	13.6*	-	-	10.1	12.8	15.6	15.5	-	-
		160	6.7*	8.8*	12.8	10.9	-	-	6.7	8.8	13.8	13.5	-	-
		180	-	5.6*	10.5	8.9	6.9	-	-	5.6	10.7	11.9	10.3	-
		200	-	-	6.9*	7.3	5.5	-	-	-	6.9	9.9	8.5	7.1
		220	-	-	-	-	-	-	-	-	-	-	7.0	5.8
	234	-	-	-	-	-	-	-	-	-	-	-	-	
	240	-	-	-	-	-	-	-	-	-	-	-	-	
	160' + 30'	74	14.1*	-	-	-	-	-	14.1*	-	-	-	-	-
		80	14.1*	-	-	-	-	-	14.1*	-	-	-	-	-
		100	13.3*	14.3*	-	-	-	-	13.3*	14.3*	-	-	-	-
120		11.6*	12.8*	13.4*	-	-	-	11.6*	12.8*	13.4*	-	-	-	
140		7.8*	10.5*	12.0*	-	-	-	7.8*	10.5*	12.0*	-	-	-	
160		-	6.9*	10.5*	10.0	-	-	-	6.9*	10.5*	10.3*	-	-	
180		-	-	9.2*	8.0	-	-	-	-	9.2*	9.0*	8.2*	-	
200		-	-	5.9*	6.4	-	-	-	-	5.9*	7.8*	7.0*	-	
220		-	-	-	5.2	-	-	-	-	-	7.0*	6.1*	-	
240	-	-	-	-	-	-	-	-	-	-	5.0	-		

NOTE: *Indicates these capacities are based on factors other than those which would cause a tipping condition. Capacities shown in thousands of pounds.

LS-248H II Midfall Capacities -- 360 Degrees

Luffing Boom Length (feet)	Luffing Jib Length (feet)	Radii in feet	Capacities with 87° Luffing Boom Angle	Radii in feet	Capacities with 80° Luffing Boom Angle
80	110 thru 160	36 - 50	15.0*	53 - 60	15.0*
		50 - 65	10.0*	60 - 75	10.0*
		65 - 83	7.5*	75 - 92	7.5*
100	110 thru 160	37 - 50	15.0*	56 - 60	15.0*
		50 - 65	10.0*	60 - 75	10.0*
		65 - 84	7.5*	75 - 95	7.5*
120	110 thru 160	37 - 50	15.0*	60 - 65	15.0*
		50 - 65	10.0*	65 - 80	10.0*
		65 - 85	7.5*	80 - 99	7.5*
140	110 thru 160	38 - 50	15.0*	63 - 70	15.0*
		50 - 65	10.0*	70 - 80	10.0*
		65 - 86	7.5*	80 - 102	7.5*
160	110 thru 160	39 - 55	15.0*	67 - 70	15.0*
		55 - 70	10.0*	70 - 90	10.0*
		70 - 87	7.5*	90 - 106	7.5*
180	110 thru 160	40 - 55	15.0*	70 - 75	15.0*
		55 - 70	10.0*	75 - 90	10.0*
		70 - 88	7.5*	90 - 109	7.5*
190	110 thru 160	45 - 55	15.0*	72 - 80	15.0*
		55 - 70	10.0*	80 - 90	10.0*
		70 - 88	7.5*	90 - 111	7.5*

NOTE: *Indicates these capacities are based on factors other than those which would cause a tipping condition. Capacities shown in thousands of pounds.

Luffing Boom Length	Luffing Jib Length	Radii In Feet	360 Degrees						Over-the-End (Blocked)						
			Luffing Boom Angle						Luffing Boom Angle						
			87°	85°	80°	75°	70°	65°	87°	85°	80°	75°	70°	65°	
160'	80'	42	53.9*	-	-	-	-	-	53.9*	-	-	-	-	-	-
		60	47.4*	51.7*	-	-	-	-	47.4*	51.7*	-	-	-	-	-
		80	39.7*	40.9	38.1	-	-	-	39.7*	44.5*	45.7	-	-	-	-
		100	-	30.7	28.6	26.4	-	-	-	36.6	34.5	32.3	-	-	-
		120	-	-	-	21.0	18.7	-	-	-	-	25.4	23.7	-	-
		140	-	-	-	-	15.1	13.8	-	-	-	-	19.4	18.1	-
	156	-	-	-	-	-	11.7	-	-	-	-	-	15.3	-	
	100'	47	43.4*	-	-	-	-	-	43.4*	-	-	-	-	-	-
		60	40.9*	43.1*	-	-	-	-	40.9*	43.1*	-	-	-	-	-
		80	35.7*	39.1*	37.4	-	-	-	35.7*	39.1*	42.9*	-	-	-	-
		100	30.1*	30.3	28.0	25.8	-	-	30.1*	33.9*	33.9	31.7	-	-	-
		120	-	23.8	22.0	20.5	18.0	-	-	25.8*	26.7	24.8	23.0	-	-
		140	-	-	-	16.5	14.6	12.0	-	-	-	20.4	18.9	17.5	-
	120'	52	35.5*	-	-	-	-	-	35.5*	-	-	-	-	-	-
		60	34.5*	-	-	-	-	-	34.5*	-	-	-	-	-	-
		80	31.1*	33.8*	-	-	-	-	31.1*	33.8*	-	-	-	-	-
		100	27.1*	29.7	27.4	-	-	-	27.1*	30.5*	33.4	24.2	-	-	-
		120	20.9*	23.3	21.4	19.9	16.0	-	20.9*	24.4*	26.1	24.2	18.3	-	-
		140	-	17.8*	17.6	16.0	13.9	13.9	-	17.8*	21.2	19.9	15.1	13.8	-
	140'	58	28.4*	-	-	-	-	-	28.4*	-	-	-	-	-	-
		80	26.4*	28.4*	-	-	-	-	26.4*	28.4*	-	-	-	-	-
		100	24.1*	26.2*	26.7	-	-	-	24.1*	26.2*	28.6*	-	-	-	-
		120	19.2*	22.7*	21.2	19.2	-	-	19.2*	22.7*	25.6	23.6	-	-	-
		140	13.6*	16.6*	17.0	15.4	10.7	-	13.6*	16.6*	21.0	19.3	14.5	-	-
160		-	11.5*	14.0	12.6	8.8	7.7	-	11.5*	17.3	13.3	12.1	10.9	-	
160'	64	23.2*	-	-	-	-	-	23.2*	-	-	-	-	-	-	
	80	22.7*	23.6*	-	-	-	-	22.7*	23.6*	-	-	-	-	-	
	100	20.8*	22.4*	-	-	-	-	20.8*	22.4*	-	-	-	-	-	
	120	17.2*	21.0*	20.6	-	-	-	17.2*	21.0*	22.4*	-	-	-	-	
	140	12.2*	15.1*	16.5	14.8	10.1	-	12.2*	15.1*	20.0*	18.7	-	-	-	
	160	8.1*	10.3*	13.5	12.0	8.2	7.0	8.1*	10.3*	16.8	15.3	13.9	10.2	-	
160' + 30'	73	17.4*	-	-	-	-	-	17.4*	-	-	-	-	-	-	
	100	16.4*	17.5*	-	-	-	-	16.4*	17.5*	-	-	-	-	-	
	120	14.6*	16.1*	16.7*	-	-	-	14.6*	16.1*	16.7*	-	-	-	-	
	140	9.7*	13.0*	15.3*	-	-	-	9.7*	13.0*	15.3*	-	-	-	-	
	160	5.8*	8.3*	12.6	11.1	7.2	5.8	5.8*	8.3*	13.4*	14.3	10.6	-	-	
	180	-	-	10.3	9.0	6.6	-	-	-	11.4*	11.9	8.7	7.5	-	

180'	100'	48	36.8*	-	-	-	-	-	36.8*	-	-	-	-	-	
		60	34.8*	36.6*	-	-	-	-	34.8*	36.6*	-	-	-	-	-
		80	30.1*	33.4*	-	-	-	-	30.1*	33.4*	-	-	-	-	-
		100	25.6*	28.5*	27.3	-	-	-	25.6*	28.5*	32.8*	-	-	-	-
		120	-	23.5*	21.4	19.6	-	-	-	23.5*	26.2	24.0	-	-	-
		140	-	-	17.6	15.8	13.5	-	-	-	21.3	19.7	18.0	-	-
	120'	53	30.2*	-	-	-	-	-	30.2*	-	-	-	-	-	-
		60	29.7*	-	-	-	-	-	29.7*	-	-	-	-	-	-
		80	26.1*	29.0*	-	-	-	-	26.1*	29.0*	-	-	-	-	-
		100	23.0*	25.5*	26.7	-	-	-	23.0*	25.5*	28.6*	-	-	-	-
		120	18.9*	22.0*	21.2	19.0	-	-	18.9*	22.0*	25.2*	23.3	-	-	-
		140	-	16.4*	17.1	15.2	12.8	-	-	16.4*	21.0	19.2	17.3	-	-
	140'	59	24.4*	-	-	-	-	-	24.4*	-	-	-	-	-	-
		80	22.8*	24.5*	-	-	-	-	22.8*	24.5*	-	-	-	-	-
		100	20.5*	22.4*	25.0*	-	-	-	20.5*	22.4*	25.0*	-	-	-	-
		120	17.0*	20.2*	20.6	-	-	-	17.0*	20.2*	22.2*	-	-	-	-
		140	12.5*	14.8*	16.5	14.6	9.8	-	12.5*	14.8*	19.5*	18.6	-	-	-
		160	-	10.6*	13.6	11.9	8.0	6.6	-	10.6*	16.9*	15.3	13.6	-	-
	160'	65	20.2*	-	-	-	-	-	20.2*	-	-	-	-	-	-
		80	19.5*	20.5*	-	-	-	-	19.5*	20.5*	-	-	-	-	-
		100	17.9*	19.6*	-	-	-	-	17.9*	19.6*	-	-	-	-	-
		120	15.3*	17.9*	19.3*	-	-	-	15.3*	17.9*	19.3*	-	-	-	-
		140	10.8*	13.6*	16.0	14.0	9.1	-	10.8*	13.6*	17.1*	17.3*	-	-	-
		160	7.1*	9.4*	13.0	11.3	7.3	5.9	7.1*	9.4*	15.0*	14.7	13.0	-	-
160' + 30'	74	15.1*	-	-	-	-	-	15.1*	-	-	-	-	-	-	
	100	14.4*	15.4*	-	-	-	-	14.4*	15.4*	-	-	-	-	-	
	120	12.7*	14.0*	14.8*	-	-	-	12.7*	14.0*	14.8*	-	-	-	-	
	140	8.5*	11.5*	13.2*	-	-	-	8.5*	11.5*	13.2*	-	-	-	-	
	160	5.0*	7.4*	11.7*	10.3	6.7	5.4	5.0*	7.4*	11.7*	11.7*	9.7	-	-	
	180	-	-	9.9	8.3	5.9	-	-	-	10.3*	10.5*	8.0	-	-	

NOTE: *Indicates these capacities are based on factors other than those which would cause a tipping condition. Capacities shown in thousands of pounds.

Luffing Boom Length	Luffing Jib Length	Radii In Feet	360 Degrees						Over-the-End (Blocked)					
			Luffing Boom Angle						Luffing Boom Angle					
			87°	85°	80°	75°	70°	65°	87°	85°	80°	75°	70°	65°
120'	80'	40	74.3*	-	-	-	-	-	74.3*	-	-	-	-	-
		60	60.5	59.4	-	-	-	-	66.9*	68.3*	-	-	-	-
		80	42.2	41.4	39.5	37.6	-	-	49.9*	49.1	47.1	45.2	-	-
		100	-	31.2	29.7	28.2	26.0	-	-	37.0	35.5	34.0	32.6	-
		120	-	-	-	22.2	20.8	-	-	-	-	26.7	25.6	24.5
		139	-	-	-	-	-	19.7	16.0	-	-	-	-	20.1
	100'	45	60.0*	-	-	-	-	-	60.0*	-	-	-	-	-
		60	56.1*	56.3*	-	-	-	-	56.1*	56.3*	-	-	-	-
		80	41.7	40.9	38.9	-	-	-	49.4	48.6	46.5	-	-	-
		100	31.3	30.7	29.2	27.6	-	-	36.8*	36.6	35.0	33.5	-	-
		120	-	24.3	23.0	21.7	20.1	-	-	28.6*	27.6	26.3	25.1	-
		140	-	-	-	17.7	16.4	15.4	-	-	-	21.4	20.6	19.6
	120'	51	47.1*	-	-	-	-	-	47.1*	-	-	-	-	-
		60	46.2*	46.7*	-	-	-	-	46.2*	46.7*	-	-	-	-
		80	41.2	40.3	38.3	-	-	-	42.8*	44.3*	43.4*	-	-	-
		100	30.9	30.2	28.6	27.0	-	-	34.1*	36.1	34.5	32.9	-	-
		120	24.2*	23.7	22.4	21.2	19.5	-	24.2*	28.4	27.1	25.7	24.5	-
		140	-	19.5	18.4	17.3	15.8	14.7	-	19.8*	22.0	21.1	20.0	19.0
	140'	56	37.8*	-	-	-	-	-	37.8*	-	-	-	-	-
		80	35.3*	36.2*	-	-	-	-	35.3*	36.2*	-	-	-	-
		100	30.3	29.6	28.0	-	-	-	32.3*	35.4*	33.9	-	-	-
		120	22.9*	23.2	21.8	20.8	-	-	22.9*	27.2*	26.5	25.1	-	-
		140	15.8*	18.7*	17.9	16.7	15.1	-	15.8*	18.7*	21.4	20.6	19.5	-
		180	-	12.7*	14.7	13.7	12.4	11.5	-	12.7*	18.0	17.0	16.0	15.1
160'	62	30.1*	-	-	-	-	-	30.1*	-	-	-	-	-	
	80	29.3*	29.7*	-	-	-	-	29.3*	29.7*	-	-	-	-	
	100	27.6*	27.7*	27.3*	-	-	-	27.6*	27.7*	27.3*	-	-	-	
	120	21.1*	22.7	21.2	20.2	-	-	21.1*	25.4*	26.0	24.5	-	-	
	140	14.2*	17.5*	17.3	16.2	14.5	-	14.2*	17.5*	21.2	20.0	18.9	-	
	180	9.5*	11.5*	14.2	13.2	11.8	10.8	9.5*	11.5*	17.5	16.5	15.5	14.5	
160' + 30'	71	18.0*	-	-	-	-	-	18.0*	-	-	-	-	-	
	100	18.0*	18.0*	-	-	-	-	18.0*	18.0*	18.0*	-	-	-	
	120	16.9*	17.5*	18.0*	-	-	-	16.9*	17.5*	18.0*	16.9*	-	-	
	140	12.2*	14.8*	16.2*	15.3	-	-	12.2*	14.8*	16.2*	16.9*	14.6	-	
	160	7.0*	9.6*	13.4*	12.3	10.8	-	7.0*	9.6*	13.8*	14.8*	12.7*	11.1	
	200	-	-	11.0*	10.1	8.8	7.9	-	-	11.5*	12.7*	12.0	9.2	

140'	80'	41	64.9*	-	-	-	-	-	64.9*	-	-	-	-	
		60	56.6*	59.1	-	-	-	-	56.6*	61.0*	-	-	-	
		80	42.1	41.1	38.8	-	-	-	47.4*	48.9	46.5	-	-	
		100	-	30.9	29.2	27.4	-	-	-	36.8	35.0	33.2	24.7	
		120	-	-	-	21.5	19.8	-	-	-	-	26.1	24.7	23.3
		148	-	-	-	-	-	18.4	-	-	-	-	-	19.1
	100'	46	50.9*	-	-	-	-	-	50.9*	-	-	-	-	-
		60	48.0*	51.3*	-	-	-	-	48.0*	51.3*	-	-	-	-
		80	41.6	40.6	38.2	-	-	-	42.2*	45.7*	45.9	-	-	-
		100	31.3	30.5	28.6	26.8	-	-	34.0*	36.4	34.5	32.6	-	-
		120	-	24.0	22.5	21.3	19.1	-	-	27.8*	27.2	25.6	24.1	-
		168	-	-	-	17.2	15.5	14.3	-	-	-	21.0	19.8	18.6
	120'	52	41.2*	-	-	-	-	-	41.2*	-	-	-	-	-
		60	40.1*	41.7*	-	-	-	-	40.1*	41.7*	-	-	-	-
		80	36.3*	39.4*	-	-	-	-	36.3*	39.4*	-	-	-	-
		100	30.8	30.0	28.0	-	-	-	31.8*	35.5*	33.9	-	-	-
		120	22.9*	23.5	21.9	20.7	-	-	22.9*	26.7*	26.6	25.0	-	-
		188	-	18.9*	18.0	16.7	14.9	-	-	18.9*	21.6	20.5	19.2	14.8
	140'	57	33.1*	-	-	-	-	-	33.1*	-	-	-	-	-
		80	30.9*	33.1*	-	-	-	-	30.9*	33.1*	-	-	-	-
		100	27.8*	29.4	27.4	-	-	-	27.8*	30.8*	32.5*	-	-	-
		120	21.0*	23.0	21.3	20.1	-	-	21.0*	24.7*	26.1	24.4	-	-
		140	14.7*	17.7*	17.5	16.1	14.2	-	14.7*	17.7*	21.2	20.0	18.6	-
		208	-	12.3*	14.4	13.2	11.6	10.5	-	12.3*	17.7	16.5	15.3	14.2
160'	63	26.5*	-	-	-	-	-	26.5*	-	-	-	-	-	
	80	25.5*	26.9*	-	-	-	-	25.5*	26.9*	-	-	-	-	
	100	24.1*	25.8*	25.7*	-	-	-	24.1*	25.8*	25.7*	-	-	-	
	120	19.1*	22.4	21.1	-	-	-	19.1*	23.4*	25.0*	-	-	-	
	140	13.2*	16.7*	16.9	15.5	-	-	13.2*	16.7*	20.8	19.4	-	-	
	228	-	8.8*	10.9*	12.6	11.0	-	8.8*	10.9*	17.2	15.9	14.7	-	
160' + 30'	72	18.0*	-	-	-	-	-	18.0*	-	-	-	-	-	
	100	18.0*	18.0*	-	-	-	-	18.0*	18.0*	18.0*	-	-	-	
	120	16.1*	16.9*	18.0*	14.6	-	-	16.1*	16.9*	18.0*	16.6*	-	-	
	140	10.8*	14.4*	15.8*	13.0	11.7	-	10.8*	14.4*	15.8*	14.6*	-	-	
	160	6.4*	9.0*	10.7	9.5	8.0	-	6.4*	9.0*	11.6*	12.5	11.3	-	
	250	-	-	6.5*	7.8	6.5	5.3	-	-	6.5*	10.4	9.4	8.4	

NOTE: *Indicates these capacities are based on factors other than those which would cause a tipping condition. Capacities shown in thousands of pounds.

LS-248H II Luffing Crane Working Ranges

(See Crane Operating Manual for all available working ranges)

70° Luffing Boom Angle

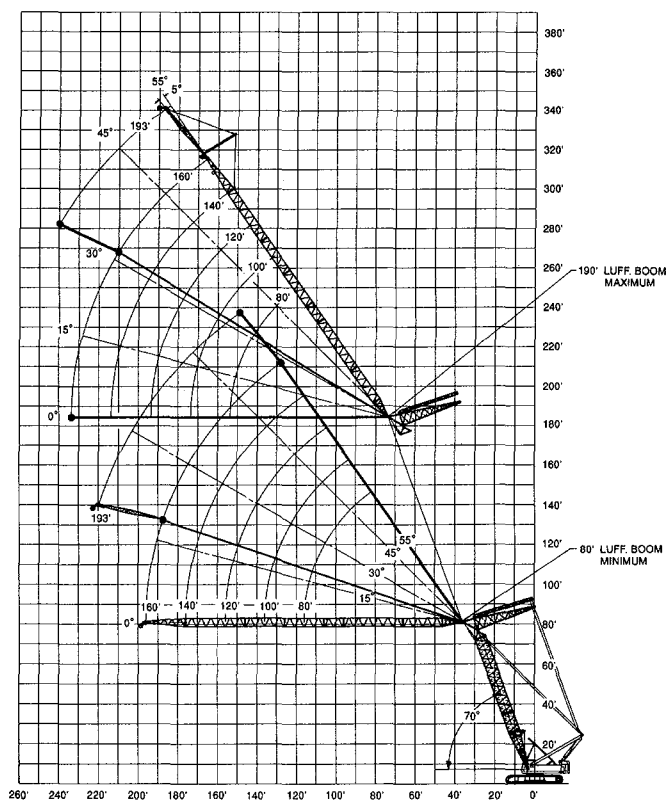

Operating Radius

87° Luffing Boom Angle

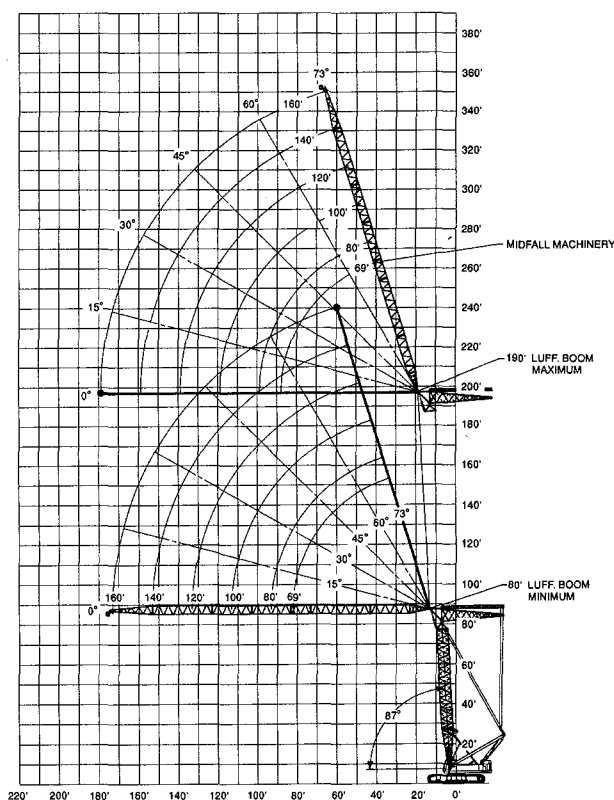

Operating Radius

Luffing Attachment Capacity Notes:

1. Capacities shown are in pounds and are not more than 75% of the tipping loads with the crane standing level on firm supporting surface. A deduction must be made from these capacities for weight of hook block, hook ball, sling, grapple, load weighing device, etc. See Operator's Manual for all limitations when raising or lowering attachment.
2. The crane capacities marked with an asterisk are based on structural strength. The crane capacities in the non-asterisked areas are based on stability ratings.
3. For recommended reeving, parts of line, wire rope type and wire rope inspection, see Operator's Manual and Parts Manual.
4. Capacities are based on freely suspended loads and make no allowances for such factors as the effect of the wind, ground conditions, and operating speeds. The operator shall therefore reduce load ratings in order to take these conditions into account.
5. The 30 ft. (9.14 m) luffing boom live mast must be used for all capacities shown in these charts.
6. The least stable rated condition is over the side.
7. The attachment must be erected and lowered directly over the end of the lower.
8. Do not operate at radii and boom lengths where charts lists no capacities. Do not use longer booms or jibs than those listed in the Crane Rating Manual. Any of the above can cause a tipping condition, or boom and jib failure.
9. Do not travel with a load.
10. Refer to the Crane Rating Manual for wind speed restriction chart for safe operation, travel and storage of the attachment.
11. Refer to the Crane Rating Manual for capacity reductions for auxiliary load handling equipment.
12. These capacities apply only to the crane as originally manufactured and normally equipped by Link-Belt Construction Equipment Company.