

# FLAT TOP TOWER CRANE



**Specifications:**

- ▶ Max jib length: 275.6 ft
- ▶ Capacity at max length: 4,850 lbs
- ▶ Max capacity: 44,092 lbs

**WORKS FOR YOU.™**

# KEY

## Zeichenerklärung · Légende · Leyenda · Legenda



Hoisting · Heben · Levage · Elevación · Sollevamento



Trolleying · Katzfahren · Distribution · Distribución · Traslazione carrello



Slewing · Schwenken · Orientation · Orientació · Rotazione



Travelling · Schienenfahren · Translation · Traslación · Traslazione



Directive on noise level · Richtlinie für den Schall-Leistungspegel · Directive sur le niveau acoustique · Directiva sobre el nivel acustico · Direttiva sul livello acustico



Consult us · Auf Anfrage · Nous consulter · Consultarnos · Consultateci



Power requirements · Geforderte Stromstärke · Puissance totale nécessaire · Potencia necesaria · Potenza totale richiesta



Power supply · Stromversorgung · Alimentation · Alimentación · Alimentazione



In service · In Betrieb · En service · En servicio · In servizio



Out of service · Außer Betrieb · Hors service · Fuera de servicio · Fuori servizio



Max. under hook height · Höchste Hakenhöhe · Hauteur maxi. sous crochet · Maxima altura bajo gancho · Altezza max. sotto gancho



Without load, without ballast, max. jib and max. height · Ohne Last und Ballast, mit Maximalausleger und Maximalhöhe · A vide, sans lest, avec flèche et hauteur maximum · Sin carga, sin lastre, con pluma y altura máxima · A vuoto, senza zavorra, braccio max., altezza max.



Counterweight · Gegengewicht · Lest de contre-flèche · Lastre de contra flecha · Zavorra controbraccio

**C25**

FEM 1004 Out of service wind condition · FEM 1004 Windverhältnisse im Außerbetriebszustand · FEM 1004 Conditions de vent hors service · FEM 1004 Condiciones de viento fuera de servicio · FEM 1004 Condizioni del vento in fuori servizio

# CONTENTS

**CTT 561A-20 HD23**

**Inhalt · Contenu · Contenido · Indice**

Page · Seite · Page · Pàgina · Pagina:

<b>Load Diagram · Lastkurven · Courbes de charges · Curvas de cargas · Diagramma di portata</b> .....	<b>4</b>
<b>Tower · Turm · Tour · Torre · Torre</b> .....	<b>6</b>
<b>Other configurations · Aufstellmöglichkeiten · Autres Implantations</b> <b>Otras Implantaciones · Altre Installazioni</b> .....	<b>8</b>
<b>Mechanisms · Antriebe · Mécanismes · Mecanismos · Meccanismi</b> .....	<b>9</b>
<b>Transportation · Transport · Transportation · Transportation · Trasporto</b> .....	<b>11</b>

# LOAD DIAGRAM

Lastkurven · Courbes de charges · Curvas de cargas · Diagramma di portata

67 AFC 100 C1 (5,512 lbs) A1 (7,871 lbs)  
3 5

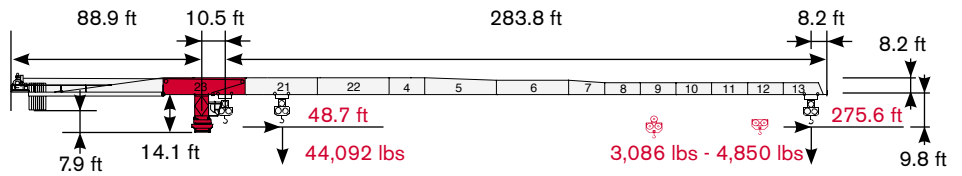

62.3 ft 78.7 ft 95.1 ft 111.6 ft 128 ft 144.4 ft 160.8 ft 177.2 ft 193.6 ft 210 ft 226.4 ft 242.8 ft 259.2 ft

22,046 lbs	92.7 ft	lbs	22,046	22,046	20,459	16,843	14,683	12,544	10,869	9,502	8,400	7,452	6,658	5,975	5,379	4,850
22,046 lbs	85.6 ft	lbs	22,046	22,046	18,276	14,771	12,655	10,582	8,951	7,628	6,526	5,622	4,850	4,167	3,594	3,086
44,092 lbs	48.7 ft	lbs	30,380	22,862	18,012	14,595	12,522	10,494	8,885	7,584	6,504	5,600	4,828	4,167	3,594	3,086

67 AFC 100 C1 (5,512 lbs) A1 (7,871 lbs)  
3 5

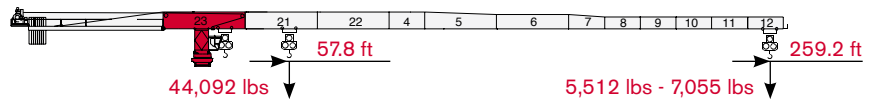

62.3 ft 78.7 ft 95.1 ft 111.6 ft 128 ft 144.4 ft 160.8 ft 177.2 ft 193.6 ft 210 ft 226.4 ft 242.8 ft 259.2 ft

22,046 lbs	109.5 ft	lbs	22,046	22,046	22,046	20,790	18,188	15,631	13,625	11,993	10,670	9,546	8,598	7,760	7,055
22,046 lbs	102.3 ft	lbs	22,046	22,046	22,046	18,960	16,402	13,911	11,949	10,362	9,039	7,937	7,011	6,217	5,512
44,092 lbs	57.8 ft	lbs	37,765	28,704	22,862	18,761	16,248	13,801	11,861	10,296	9,017	7,937	7,011	6,195	5,512

67 AFC 100 C1 (5,512 lbs) A1 (7,871 lbs)  
3 5

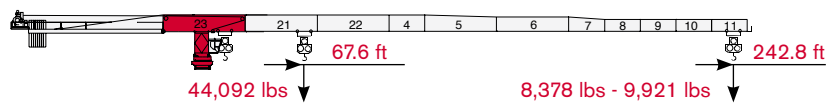

62.3 ft 78.7 ft 95.1 ft 111.6 ft 128 ft 144.4 ft 160.8 ft 177.2 ft 193.6 ft 210 ft 226.4 ft 242.8 ft

22,046 lbs	128.4 ft	lbs	22,046	22,046	22,046	22,046	22,046	19,136	16,777	14,881	13,316	11,993	10,891	9,921
22,046 lbs	120.5 ft	lbs	22,046	22,046	22,046	22,046	20,437	17,483	15,146	13,272	11,729	10,428	9,326	8,378
44,092 lbs	67.6 ft	lbs	44,092	34,965	28,043	23,193	20,260	17,350	15,080	13,228	11,685	10,406	9,326	8,378

67 AFC 100 C1 (5,512 lbs) A1 (7,871 lbs)  
0 7

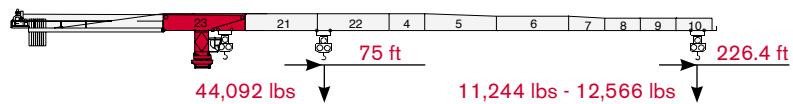

62.3 ft 78.7 ft 95.1 ft 111.6 ft 128 ft 144.4 ft 160.8 ft 177.2 ft 193.6 ft 210 ft 226.4 ft

22,046 lbs	142.4 ft	lbs	22,046	22,046	22,046	22,046	22,046	21,693	19,092	16,998	15,256	13,801	12,566
22,046 lbs	134.9 ft	lbs	22,046	22,046	22,046	22,046	22,046	20,260	17,703	15,609	13,911	12,456	11,244
44,092 lbs	75 ft	lbs	44,092	39,683	32,011	26,632	23,369	20,150	17,615	15,565	13,867	12,456	11,244

67 AFC 100 C1 (5,512 lbs) A1 (7,871 lbs)  
1 6

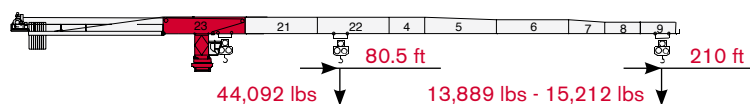

62.3 ft 78.7 ft 95.1 ft 111.6 ft 128 ft 144.4 ft 160.8 ft 177.2 ft 193.6 ft 210 ft

22,046 lbs	154 ft	lbs	22,046	22,046	22,046	22,046	22,046	22,046	20,944	18,673	16,799	15,212
22,046 lbs	145.6 ft	lbs	22,046	22,046	22,046	22,046	22,046	22,046	19,511	17,262	15,432	13,889
44,092 lbs	80.5 ft	lbs	44,092	43,144	34,899	29,123	25,618	22,156	19,445	17,240	15,410	13,889

# CTT 561A-20 HD23

  
 C1 (5,512 lbs) A1 (7,871 lbs)

67 AFC 100	1	6
------------	---	---

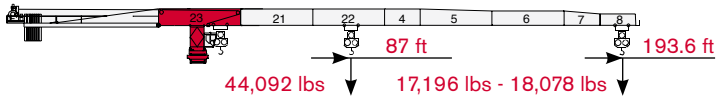

62.3 ft 78.7 ft 95.1 ft 111.6 ft 128 ft 144.4 ft 160.8 ft 177.2 ft 193.6 ft

	22,046 lbs	→	163.7 ft	lbs	22,046	22,046	22,046	22,046	22,046	22,046	22,046	22,046	20,084	18,078				
	22,046 lbs	→	158.1 ft	lbs	22,046	22,046	22,046	22,046	22,046	22,046	22,046	21,605	19,180	17,196				
	44,092 lbs	→	87 ft	lbs	44,092	44,092	38,272	32,033	28,241	24,493	21,539	19,158	17,196					

  
 C1 (5,512 lbs) A1 (7,871 lbs)

67 AFC 100	2	5
------------	---	---

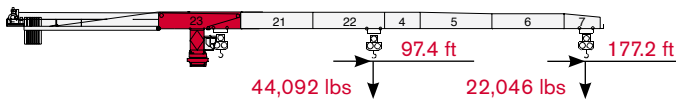

62.3 ft 78.7 ft 95.1 ft 111.6 ft 128 ft 144.4 ft 160.8 ft 177.2 ft

	22,046 lbs	→	177.2 ft	lbs	22,046	22,046	22,046	22,046	22,046	22,046	22,046	22,046	22,046					
	22,046 lbs	→	177.2 ft	lbs	22,046	22,046	22,046	22,046	22,046	22,046	22,046	22,046	22,046					
	44,092 lbs	→	97.4 ft	lbs	44,092	44,092	43,585	36,553	32,276	28,065	24,736	22,046						

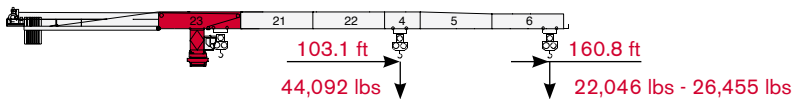

  
 C1 (5,512 lbs) A1 (7,871 lbs)

67 AFC 100	3	4
------------	---	---



62.3 ft 78.7 ft 95.1 ft 111.6 ft 128 ft 144.4 ft 160.8 ft

	22,046 lbs	→	160.8 ft	lbs	22,046	22,046	22,046	22,046	22,046	22,046	22,046							
	22,046 lbs	→	160.8 ft	lbs	22,046	22,046	22,046	22,046	22,046	22,046	22,046							
	44,092 lbs	→	103.1 ft	lbs	44,092	44,092	44,092	39,000	34,458	29,983	26,455							

  
 C1 (5,512 lbs) A1 (7,871 lbs)

67 AFC 100	0	5
------------	---	---

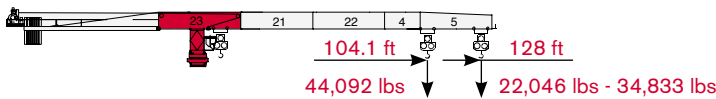

62.3 ft 78.7 ft 95.1 ft 111.6 ft 128 ft

	22,046 lbs	→	128 ft	lbs	22,046	22,046	22,046	22,046	22,046									
	22,046 lbs	→	128 ft	lbs	22,046	22,046	22,046	22,046	22,046									
	44,092 lbs	→	104.1 ft	lbs	44,092	44,092	44,092	39,419	34,833									

# TOWER

Turn · Tour · Torre · Torre

Standard Configurations · Standardkonfiguration · Standard Implantations · Implantaciones Standard · Installazioni Standard

Tower: HD23 & Basement: R1

	●	◊
R1	-3460 kN	-4123 kN
R2	2652 kN	3451 kN
	1150 kN	

Tower: HD23 & Basement: FP1

	●	◊
R1	-1717 kN	-1585 kN
R2	0 kN	0 kN
	1300 kN	

Tower: HD23 & Basement: T1

	●	◊
R1	-1717 kN	-1585 kN
R2	0 kN	0 kN
	1300 kN	

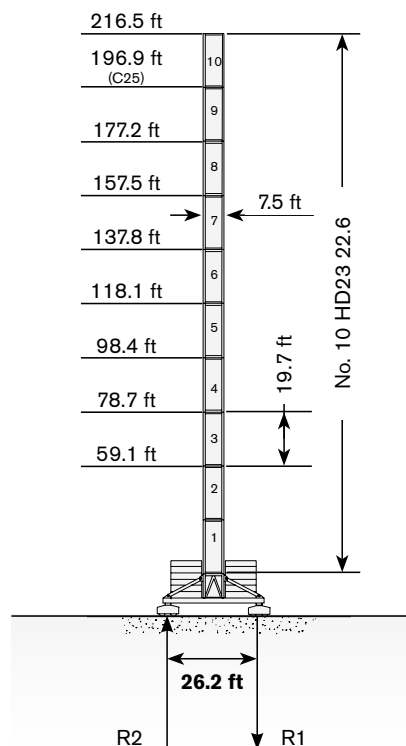
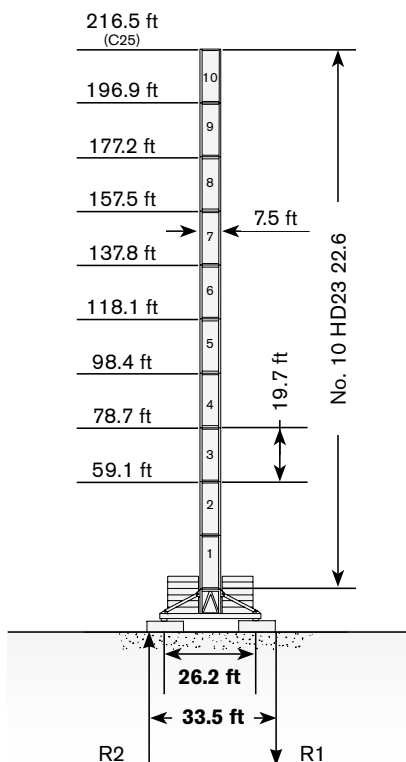
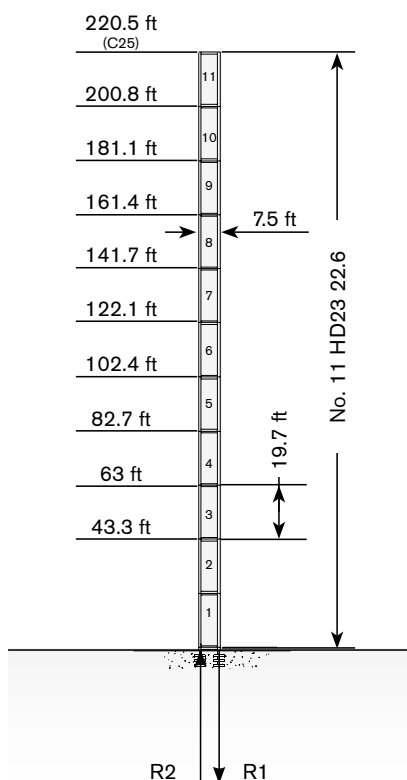

Max. under hook height · Höchste Hakenhöhe · Hauteur maxi. sous crochet · Maxima altura bajo gancho · Altezza max. sotto gancio

Different heights and tower combinations are available; please consult us · Andere Höhen und Turmkombinationen auf Anfrage · Différentes hauteurs et combinaisons de tour sont disponibles; nous consulter · Hay diferentes alturas y combinaciones de torre disponibles. Consúltenos · Altezze diverse e combinazioni di torre sono disponibili; consultateci

**Tower: HD23 & Basement: R2**

	●	◊
<b>R1</b>	-4291 kN	-5546 kN
<b>R2</b>	3377 kN	4772 kN
	1350 kN	

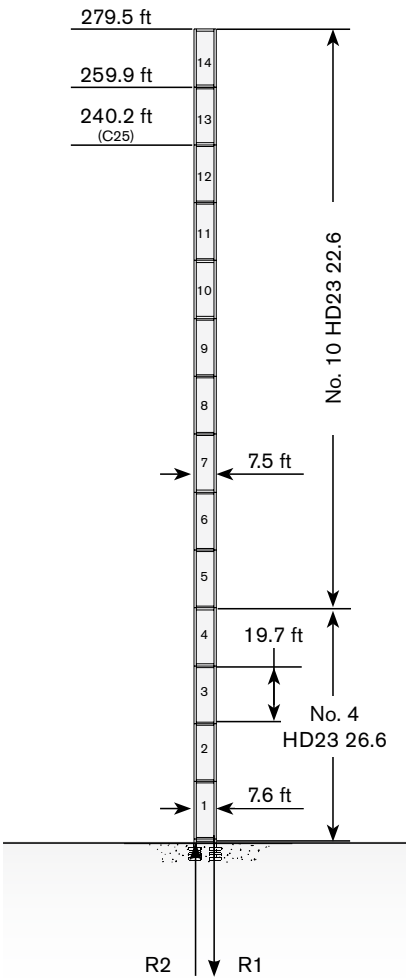

**Tower: HD23 & Basement: FP6**

	●	◊
<b>R1</b>	-1550 kN	-1878 kN
<b>R2</b>	0 kN	0 kN
	1600 kN	

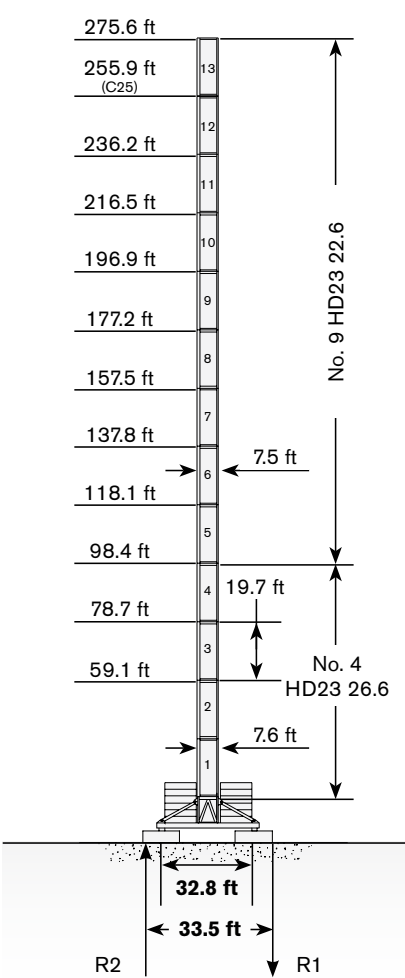

**Tower: HD23 & Basement: T6**

	●	◊
<b>R1</b>	-1763 kN	-1859 kN
<b>R2</b>	0 kN	0 kN
	1650 kN	

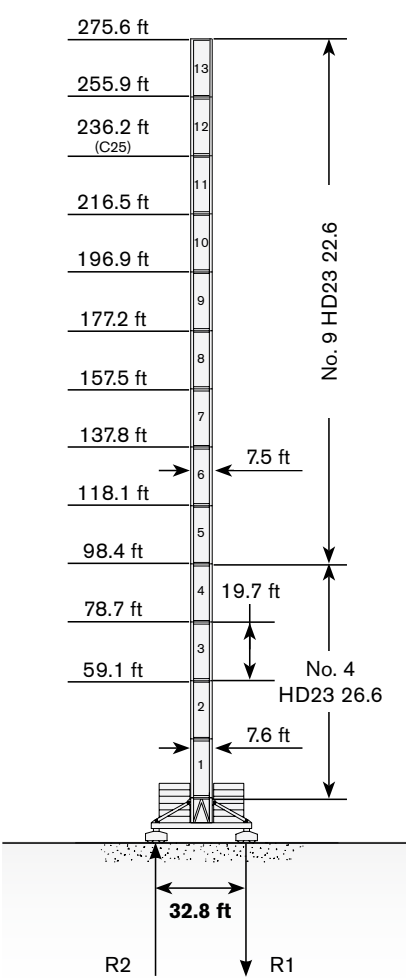

# TOWER

Turn · Tour · Torre · Torre

## Other configurations · Aufstellmöglichkeiten · Autres Implantations · Otras Implantaciones · Altre Installazioni

Bottom climbing crane · Kletterkran im Gebäude · Télescopage sur dalles · Telescopage grúa trepadora · Gru climbing

Crane tied to the structure · Geankerter Kran · Grue ancrée · Grúa anclada · Gru ancorata

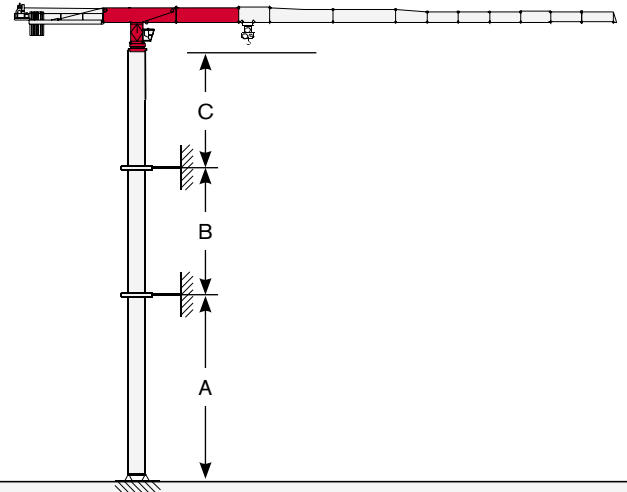
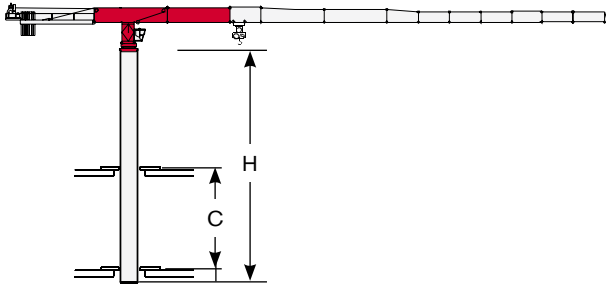

Tower: HD23-22

C min	H max
39.4 ft	118.1 ft
45.9 ft	137.8 ft
52.5 ft	157.5 ft

Tower: HD23 & Basement: R1

	min	max
A	118.1 ft	196.9 ft
B	78.7 ft	137.8 ft
C	137.8 ft	

Tower: HD23 & Basement: R2

	min	max
A	118.1 ft	236.2 ft
B	78.7 ft	137.8 ft
C	137.8 ft	



# MECHANISMS

**CTT 561A-20 HD23**





**Antriebe · Mécanismes · Mecanismos · Meccanismi**

**Power supply · Stromversorgung · Alimentation · Suministro eléctrico · Alimentazione**

				
	67 AFC 100 F18	160 kVA*	400V - 50Hz / 460V - 60Hz	2000/14/CE modificata

\* Crane without travelling equipment – Three movements simultaneous at 90% · Krane ohne Schienenfahren – Drei gleichzeitige Bewegungen mit 90% · Grue sans translation – Trois mouvements simultanés à 90% · Grúa sin traslación – Tres movimientos contemporáneos hechos al 90% · Gru senza traslazione – Tre movimenti contemporanei al 90%

**Hoisting · Heben · Levage · Elevación · Sollevamento**

			lbs	ft/min	kW	
	67 AFC 100 F18 (Vector)		22,046	0 → 111.6	67	1,640.5 ft
			17,637	0 → 134.5		
			13,228	0 → 177.2		
			8,818	0 → 252.6		
			5,291	0 → 387.2		
			44,092	0 → 55.8		
			35,274	0 → 67.3		
			26,455	0 → 88.6		
			17,637	0 → 126.3		
			10,582	0 → 193.6		

# MECHANISMS

Antriebe · Mécanismes · Mecanismos · Meccanismi

Hoisting Speed · Heben Geschwindigkeit · Vitesse de Levage ·  
Velocidad de Elevación · Velocità' di Sollevamento

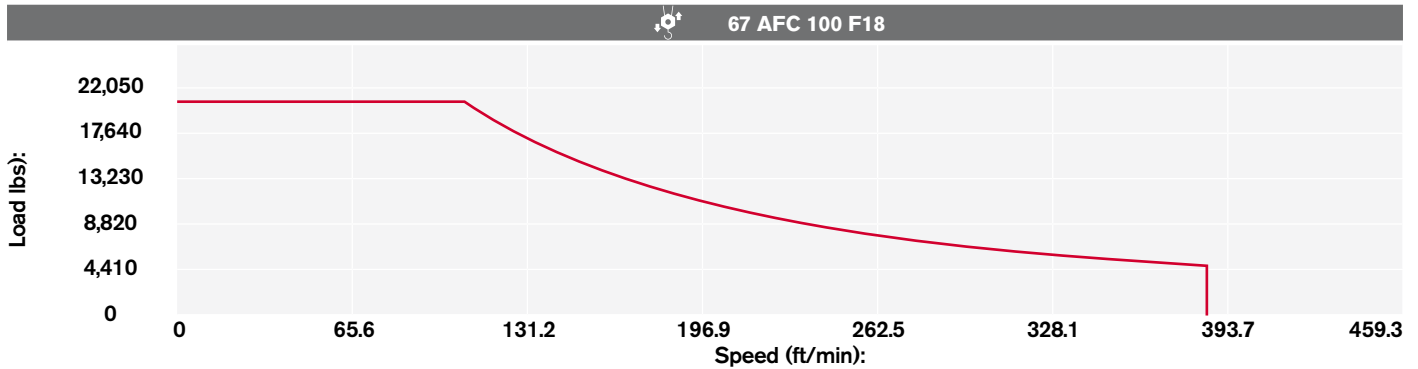

Additional Specifications · Weitere Leistungsdaten ·  
Spécifications additionnelles · Otras prestaciones · Altre movimentazioni

	DVF 5 11	0 → 328,1 ft/min	11 kW
	SSR 4 4 65	0.73 r.p.m.	4 x 59 ft·lb
	TVF 2RG 4M9 D1	0 → 78.7 ft/min	4 x 9 kw
	TSR 2RG 4M8	39.4 → 78.7 ft/min (50 Hz) 45.9 → 91.9 ft/min (60 Hz)	4 x 59 ft·lb
	TSR 4RG 4M8	39.4 → 78.7 ft/min (50 Hz) 45.9 → 91.9 ft/min (60 Hz)	4 x 59 ft·lb

Tower height max.

		T1	T6
	TVF 2RG 4M9 D1	156.2 ft	156.2 ft
	TSR 2RG 4M8	156.2 ft	156.2 ft
	TSR 4RG 4M8	> 156.2 ft	> 156.2 ft

# TRANSPORTATION

## CTT 561A-20 HD23

Transport · Transport · Conducción · Trasporto

### Packing list

CTT 561A -20 HD23	DESCRIPTION · BESCHREIBUNG · DESCRIPTION · DESCRIPCIÓN · DESCRIZIONE	LENGTH · LÄNGE · LONGUEUR · LONGITUD · LUNGHEZZA	WIDTH · BREITE · LARGEUR · ANCHURA · LARGHEZZA	HEIGHT · HÖHE · HAUTEUR · ALTURA · ALTEZZA	QUANTITY · MENGE · QUANTITÉ · CANTIDAD · QUANTITÀ	WEIGHT · GEWICHT · POIDS · PESO · PESO
	8x8 m UNDERCARRIAGE STRUT MOUNTING TOWER SECTION	9.5 ft	9.5 ft	9.5 ft	1	20,176 lbs
	8x8 m UNDERCARRIAGE STRUT	14.1 ft	1 ft	7.4 ft	4	4,013 lbs
	8x8 m UNDERCARRIAGE INTERNAL BEAM	13.1 ft	0.5 ft	1.1 ft	4	463 lbs
	8x8 m UNDERCARRIAGE EXTERNAL BEAM	19.6 ft	1 ft	1.1 ft	4	1,380 lbs
	10x10 m UNDERCARRIAGE STRUT MOUNTING TOWER SECTION	9.8 ft	9.8 ft	10.2 ft	1	23,042 lbs
	10x10 m LEFT + RIGHT UNDERCARRIAGE STRUT	18.7 ft	8.5 ft	2.3 ft	2 left + 2 right	8,434 lbs
	CROSSBEAM FOR TRAVELLING 10x10 m UNDERCARRIAGE	23 ft	7.2 ft	1.3 ft	2	4,476 lbs
	10x10 m UNDERCARRIAGE ELECTRICAL BOX SUPPORT PLATFORM FOR TVF 4RT 4M9 TRAVELLING DRIVE UNIT	18.7 ft	7.2 ft	7.9 ft	1	2,867 lbs
	10x10 m UNDERCARRIAGE ELECTRICAL BOX SUPPORT PLATFORM FOR TSR 4RG 4M8 TRAVELLING DRIVE UNIT	18.4 ft	6.9 ft	12.1 ft	1	1,422 lbs
	TOWER SECTION HD23 26.6	19.7 ft	8 ft	7.6 ft	1	14,273 lbs*
	TOWER SECTION HD23 22.6	19.7 ft	7.5 ft	7.5 ft	1	10,635 lbs*
	TOWER SECTION HD23 22.3	9.8 ft	7.5 ft	7.5 ft	1	5,623 lbs*
	SLEWING UNIT	9.7 ft	7.6 ft	7.3 ft	1	25,358 lbs

\* inclusive of ladders, platforms and assembly equipment

\*\* inclusive of tie-bars and safety rails

\*\*\* inclusive of trolley winch and accessories

\*\*\*\* ballast plates not included

# TRANSPORTATION

Transport · Transport · Conducción · Trasporto

CTT 561A -20 HD23	DESCRIPTION · BESCHREIBUNG · DESCRIPTION · DESCRIPCIÓN · DESCRIZIONE	LENGTH · LÄNGE · LONGUEUR · LONGITUD · LUNGHEZZA	WIDTH · BREITE · LARGEUR · ANCHURA · LARGHEZZA	HEIGHT · HÖHE · HAUTEUR · ALTURA · ALTEZZA	QUANTITY · MENGE · QUANTITÉ · CANTIDAD · QUANTITÀ	WEIGHT · GEWICHT · POIDS · PESO · PESO
	CAB SUPPORT PLATFORM	18.2 ft	6.1 ft	8.8 ft	1	4,410 lbs
	CAB TOWER SECTION	6.2 ft	8.2 ft	10.6 ft	1	6,725 lbs
	COUNTERJIB "1C"	23.5 ft	6.5 ft	2.8 ft	1	8,710 lbs**
	COUNTERJIB "3C"	38.3 ft	7.3 ft	3.6 ft	1	12,789 lbs**
	JIB SECTION-23 23TT19 23.12	39.4 ft	8.3 ft	8.3 ft	1	24,255 lbs***
	JIB TROLLEY 20-24 t	7.8 ft	7.5 ft	4.8 ft	1	1,687 lbs
	JIB SECTION-21 21TT19 23.10	33.8 ft	6.1 ft	8.3 ft	1	10,805 lbs
	JIB SECTION-22 22TT19 23.10	33.9 ft	6.1 ft	8.2 ft	1	8,820 lbs
	JIB SECTION-04 TT19 23.05	16.4 ft	6.1 ft	8.2 ft	1	3,969 lbs
	JIB SECTION-05 TT19 23.10	32.8 ft	6.1 ft	8.2 ft	1	5,954 lbs
	JIB SECTION-06 TT19 20.10	33.8 ft	6.1 ft	7.2 ft	1	4,256 lbs
	JIB SECTION-07 TT1920.05	17.3 ft	6.1 ft	7.2 ft	1	1,985 lbs
	JIB SECTION-08 TT1917.05	17.2 ft	6.1 ft	6.1 ft	1	1,720 lbs
	JIB SECTION-09 TT1917.05	17.1 ft	6.1 ft	6.1 ft	1	2,073 lbs







\* inclusive of ladders, platforms and assembly equipment

\*\* inclusive of tie-bars and safety rails

\*\*\* inclusive of trolley winch and accessories

\*\*\*\* ballast plates not included

# CTT 561A-20 HD23

CTT 561A -20 HD23	DESCRIPTION · BESCHREIBUNG · DESCRIPTION · DESCRIPCIÓN · DESCRIZIONE	LENGTH · LÄNGE · LONGUEUR · LONGITUD · LUNGHEZZA	WIDTH · BREITE · LARGEUR · ANCHURA · LARGHEZZA	HEIGHT · HÖHE · HAUTEUR · ALTURA · ALTEZZA	QUANTITY · MENGE · QUANTITÉ · CANTIDAD · QUANTITÀ	WEIGHT · GEWICHT · POIDS · PESO · PESO
	JIB SECTION-10 TT1917.05	17 ft	6.1 ft	6.1 ft	1	1,147 lbs
	JIB SECTION-11 TT1917.05	16.9 ft	6.1 ft	6.1 ft	1	997 lbs
	JIB SECTION-12 TT1917.05	16.9 ft	6.1 ft	5.8 ft	1	838 lbs
	JIB SECTION-13 TT1917.05	16.9 ft	6.1 ft	5.8 ft	1	717 lbs
	JIB POINT 20/24 t	7 ft	3.9 ft	5.3 ft	1	595 lbs
	4-PART LINE HOIST BLOCK 20-24 t	5.2 ft	2 ft	5.4 ft	1	1,863 lbs****
	HOIST WINCH 67AFC 100 F18 VECTOR (without platforms, safety rails and rope)	10.8 ft	7 ft	7.8 ft	1	9,724 lbs

# NOTES

Notizen · Note · Apunte · Appunti

---

---

---

---

---

---

---

---

---

---

---

---

---

---

---

---

---

---

---

---

---

---

---

---

Lined writing area consisting of 20 horizontal lines.

[www.terexcranes.com](http://www.terexcranes.com)

Effective Date: June 2010.

Product specifications and prices are subject to change without notice or obligation. The photographs and/or drawings in this document are for illustrative purposes only. Refer to the appropriate Operator's Manual for instructions on the proper use of this equipment. Failure to follow the appropriate Operator's Manual when using our equipment or to otherwise act irresponsibly may result in serious injury or death. The only warranty applicable to our equipment is the standard written warranty applicable to the particular product and sale and Terex makes no other warranty, express or implied. Products and services listed may be trademarks, service marks or trade-names of Terex Corporation and/or its subsidiaries in the USA and other countries. All rights are reserved. Terex® is a registered trademark of Terex Corporation in the USA and many other countries.

Gültig ab: Juni 2010.

Produktbeschreibungen und Preise können jederzeit und ohne Verpflichtung zur Ankündigung geändert werden. Die in diesem Dokument enthaltenen Fotos und/oder Zeichnungen dienen rein anschaulichen Zwecken. Anweisungen zur ordnungsgemäßen Verwendung dieser Ausrüstung entnehmen Sie bitte dem zugehörigen Betriebshandbuch. Nichtbefolgung des Betriebshandbuchs bei der Verwendung unserer Produkte oder anderweitig fahrlässiges Verhalten kann zu schwerwiegenden Verletzungen oder Tod führen. Für dieses Produkt wird ausschließlich die entsprechende, schriftlich niedergelegte Standardgarantie gewährt. Terex leistet keinerlei darüber hinaus gehende Garantie, weder ausdrücklich noch stillschweigend. Die Bezeichnungen der aufgeführten Produkte und Leistungen sind gegebenenfalls Marken, Servicemarken oder Handelsnamen der Terex Corporation und/oder ihrer Tochtergesellschaften in den USA und anderen Ländern. Alle Rechte vorbehalten. „TEREX“ ist eine eingetragene Marke der Terex Corporation in den USA und vielen anderen Ländern.

Date d'effet : Juin 2010.

Les spécifications et prix des produits sont sujets à modification sans avis ou obligation. Les photographies et/ou dessins contenus dans ce document sont uniquement pour illustration. Veuillez vous référer à la notice d'utilisation appropriée pour les instructions quant à l'utilisation correcte de cet équipement. Tout manquement au suivi de la notice d'utilisation appropriée lors de l'utilisation de notre équipement ou tout acte autrement irresponsable peut résulter en blessure corporelle sérieuse ou mortelle. La seule garantie applicable à notre équipement est la garantie standard écrite applicable à un produit et à une vente spécifique. Terex n'offre aucune autre garantie, expresse ou implicite. Les produits et services proposés peuvent être des marques de fabrique, des marques de service ou des appellations commerciales de Terex Corporation et/ou ses filiales aux Etats Unis et dans les autres pays, et tous les droits sont réservés. «TEREX» est une marque déposée de Terex Corporation aux Etats Unis et dans de nombreux autres pays.

Fecha efectiva: Junio 2010.

Los precios y las especificaciones de productos pueden sufrir cambios sin aviso previo u obligación. Las fotografías o dibujos de este documento tienen un fin meramente ilustrativo. Consulte el manual de instrucciones del operador correspondiente para más información sobre el uso correcto de este equipo. El hecho de no respetar el manual del operador correspondiente al utilizar el equipo o actuar de forma irresponsable puede suponer lesiones graves o fatales. La única garantía aplicable a nuestro equipo es la garantía escrita estándar correspondiente a cada producto y venta, y TEREX no amplía dicha garantía de forma expresa o implícita. Los productos y servicios mencionados pueden ser marcas registradas, marcas de servicio o nombres de marca de TEREX Corporation o de sus filiales en Estados Unidos de América y otros países, y se reservan todos los derechos. „TEREX“ es una marca comercial registrada de Terex Corporation en Estados Unidos de América y muchos otros países.

Data di inizio validità: Giugno 2010.

Ci riserviamo il diritto di modificare le specifiche e i prezzi dei prodotti in ogni momento e senza preavviso. Le fotografie e/o i disegni contenuti in questo documento sono destinati unicamente a scopi illustrativi. Consultare le istruzioni sull'uso corretto di questo macchinario, contenute nell'opportuno Manuale dell'operatore. L'inottemperanza delle istruzioni contenute nel Manuale dell'operatore del macchinario e altri comportamenti irresponsabili possono provocare gravi lesioni, anche mortali. L'unica garanzia applicabile ai nostri macchinari è la garanzia scritta standard applicabile al particolare prodotto e alla particolare vendita; Terex è esonerata dal fornire qualsiasi altra garanzia, esplicita o implicita. I prodotti e servizi elencati possono essere dei marchi di fabbrica, marchi di servizio o nomi commerciali di TEREX Corporation e/o società affiliate negli Stati Uniti d'America e altre nazioni e tutti i diritti sono riservati. „TEREX“ è un marchio registrato di Terex Corporation negli USA e molti altri Paesi.

Copyright 2010 Terex Corporation

Terex Cranes, Global Marketing, Dinglerstraße 24, 66482 Zweibrücken, Germany  
Tel. +49 (0) 6332 830, Email: [info.cranes@terex.com](mailto:info.cranes@terex.com), [www.terexcranes.com](http://www.terexcranes.com)

Brochure Reference: TC-DS-M-E/F/G/I/S-CTT561A-20 HD23-06/10



**WORKS FOR YOU.™**